

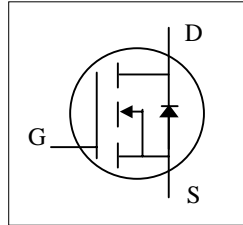

- ▼ 100% Avalanche Test
- ▼ Fast Switching Characteristics
- ▼ Simple Drive Requirement
- ▼ RoHS Compliant & Halogen-Free



| | |
|--------------|-------------|
| BV_{DSS} | 600V |
| $R_{DS(ON)}$ | 12 Ω |
| I_D | 1A |

Description

The TO-252 package is widely preferred for commercial-industrial surface mount applications and suited for AC/DC converters. The through-hole version (AP01L60J) is available for low-profile applications.

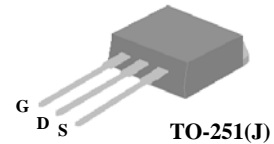
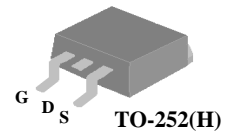

Absolute Maximum Ratings @ $T_j=25^\circ\text{C}$ (unless otherwise specified)

| Symbol | Parameter | Rating | Units |
|-----------------------------|--|------------|---------------------|
| V_{DS} | Drain-Source Voltage | 600 | V |
| V_{GS} | Gate-Source Voltage | ± 30 | V |
| $I_D@T_C=25^\circ\text{C}$ | Drain Current, V_{GS} @ 10V | 1 | A |
| $I_D@T_C=100^\circ\text{C}$ | Drain Current, V_{GS} @ 10V | 0.8 | A |
| I_{DM} | Pulsed Drain Current ¹ | 3 | A |
| $P_D@T_C=25^\circ\text{C}$ | Total Power Dissipation | 29 | W |
| | Linear Derating Factor | 0.232 | W/ $^\circ\text{C}$ |
| E_{AS} | Single Pulse Avalanche Energy ² | 0.5 | mJ |
| I_{AR} | Avalanche Current | 1 | A |
| E_{AR} | Repetitive Avalanche Energy | 0.5 | mJ |
| T_{STG} | Storage Temperature Range | -55 to 150 | $^\circ\text{C}$ |
| T_J | Operating Junction Temperature Range | -55 to 150 | $^\circ\text{C}$ |

Thermal Data

| Symbol | Parameter | Value | Units |
|--------|---|-------|---------------------------|
| Rthj-c | Maximum Thermal Resistance, Junction-case | 4.3 | $^\circ\text{C}/\text{W}$ |
| Rthj-a | Maximum Thermal Resistance, Junction-ambient (PCB mount) ⁴ | 62.5 | $^\circ\text{C}/\text{W}$ |
| Rthj-a | Maximum Thermal Resistance, Junction-ambient | 110 | $^\circ\text{C}/\text{W}$ |



AP01L60H/J-HF

Electrical Characteristics @ $T_j=25^\circ\text{C}$ (unless otherwise specified)

| Symbol | Parameter | Test Conditions | Min. | Typ. | Max. | Units |
|------------------------------|--|--|------|------|-----------|--------------------|
| BV_{DSS} | Drain-Source Breakdown Voltage | $V_{GS}=0V, I_D=1mA$ | 600 | - | - | V |
| $\Delta BV_{DSS}/\Delta T_j$ | Breakdown Voltage Temperature Coefficient | Reference to $25^\circ\text{C}, I_D=1mA$ | - | 0.8 | - | $V/^\circ\text{C}$ |
| $R_{DS(ON)}$ | Static Drain-Source On-Resistance ³ | $V_{GS}=10V, I_D=0.5A$ | - | - | 12 | Ω |
| $V_{GS(th)}$ | Gate Threshold Voltage | $V_{DS}=V_{GS}, I_D=250\mu A$ | 2 | - | 4 | V |
| g_{fs} | Forward Transconductance | $V_{DS}=10V, I_D=0.5A$ | - | 0.8 | - | S |
| I_{DSS} | Drain-Source Leakage Current | $V_{DS}=600V, V_{GS}=0V$ | - | - | 10 | μA |
| | Drain-Source Leakage Current ($T_j=125^\circ\text{C}$) | $V_{DS}=480V, V_{GS}=0V$ | - | - | 100 | μA |
| I_{GSS} | Gate-Source Leakage | $V_{GS}=\pm 30V, V_{DS}=0V$ | - | - | ± 100 | nA |
| Q_g | Total Gate Charge ³ | $I_D=1A$ | - | 4.0 | - | nC |
| Q_{gs} | Gate-Source Charge | $V_{DS}=480V$ | - | 1.0 | - | nC |
| Q_{gd} | Gate-Drain ("Miller") Charge | $V_{GS}=10V$ | - | 1.1 | - | nC |
| $t_{d(on)}$ | Turn-on Delay Time ³ | $V_{DD}=300V$ | - | 6.6 | - | ns |
| t_r | Rise Time | $I_D=1A$ | - | 5.0 | - | ns |
| $t_{d(off)}$ | Turn-off Delay Time | $R_G=3.3\Omega, V_{GS}=10V$ | - | 11.7 | - | ns |
| t_f | Fall Time | $R_D=300\Omega$ | - | 9.2 | - | ns |
| C_{iss} | Input Capacitance | $V_{GS}=0V$ | - | 170 | - | pF |
| C_{oss} | Output Capacitance | $V_{DS}=25V$ | - | 30.7 | - | pF |
| C_{rss} | Reverse Transfer Capacitance | $f=1.0MHz$ | - | 5.1 | - | pF |

Source-Drain Diode

| Symbol | Parameter | Test Conditions | Min. | Typ. | Max. | Units |
|----------|---|---|------|------|------|-------|
| I_S | Continuous Source Current (Body Diode) | $V_D=V_G=0V, V_S=1.2V$ | - | - | 1 | A |
| I_{SM} | Pulsed Source Current (Body Diode) ¹ | | - | - | 5 | A |
| V_{SD} | Forward On Voltage ³ | $T_j=25^\circ\text{C}, I_S=1A, V_{GS}=0V$ | - | - | 1.2 | V |

Notes:

1. Pulse width limited by Max. junction temperature.
2. Starting $T_j=25^\circ\text{C}$, $V_{DD}=50V$, $L=1.0mH$, $R_G=25\Omega$, $I_{AS}=1.0A$.
3. Pulse test
4. Surface mounted on 1 in^2 copper pad of FR4 board

THIS PRODUCT IS SENSITIVE TO ELECTROSTATIC DISCHARGE, PLEASE HANDLE WITH CAUTION.

USE OF THIS PRODUCT AS A CRITICAL COMPONENT IN LIFE SUPPORT OR OTHER SIMILAR SYSTEMS IS NOT AUTHORIZED.

APEC DOES NOT ASSUME ANY LIABILITY ARISING OUT OF THE APPLICATION OR USE OF ANY PRODUCT OR CIRCUIT DESCRIBED HEREIN; NEITHER DOES IT CONVEY ANY LICENSE UNDER ITS PATENT RIGHTS, NOR THE RIGHTS OF OTHERS.

APEC RESERVES THE RIGHT TO MAKE CHANGES WITHOUT FURTHER NOTICE TO ANY PRODUCTS HEREIN TO IMPROVE RELIABILITY, FUNCTION OR DESIGN.

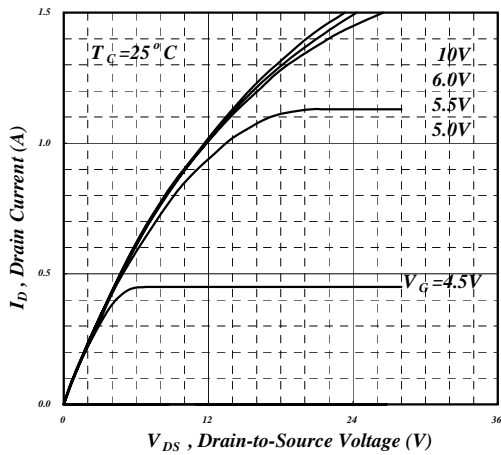

Fig 1. Typical Output Characteristics

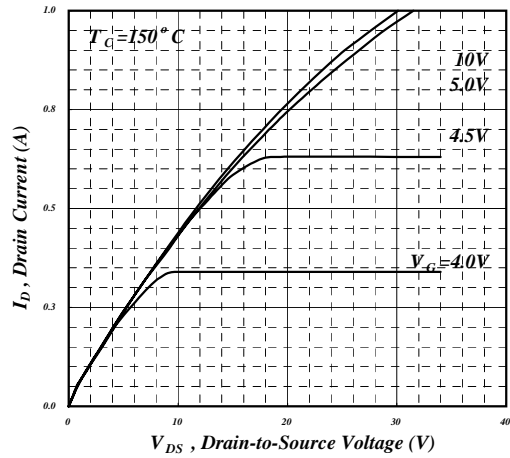

Fig 2. Typical Output Characteristics

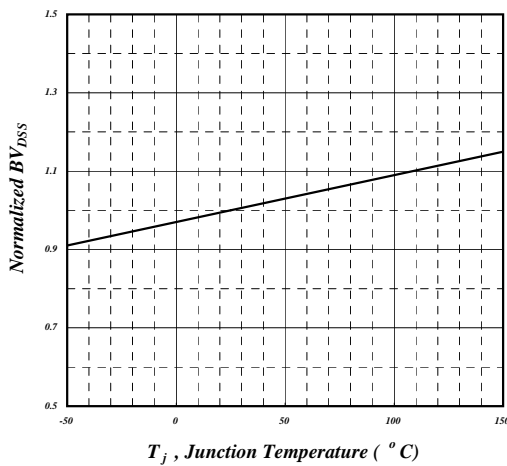

Fig 3. Normalized BV_{DSS} v.s. Junction Temperature

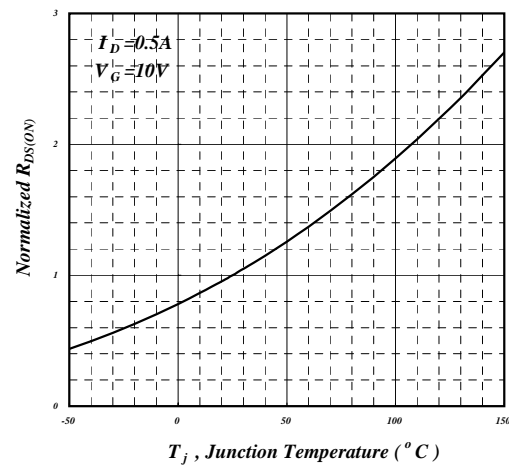

Fig 4. Normalized On-Resistance v.s. Junction Temperature

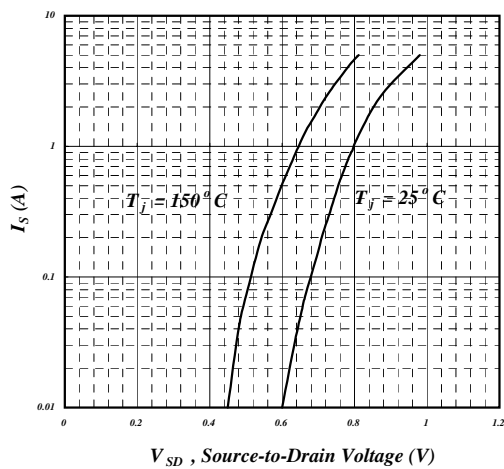

Fig 5. Forward Characteristic of Reverse Diode

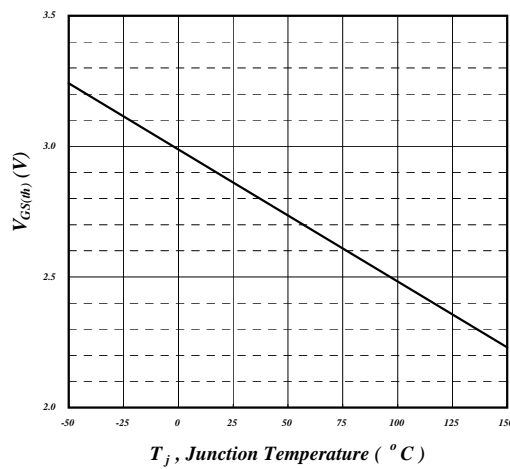

Fig 6. Gate Threshold Voltage v.s. Junction Temperature

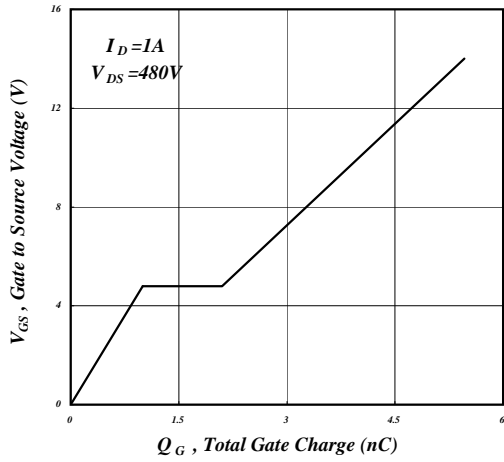

Fig 7. Gate Charge Characteristics

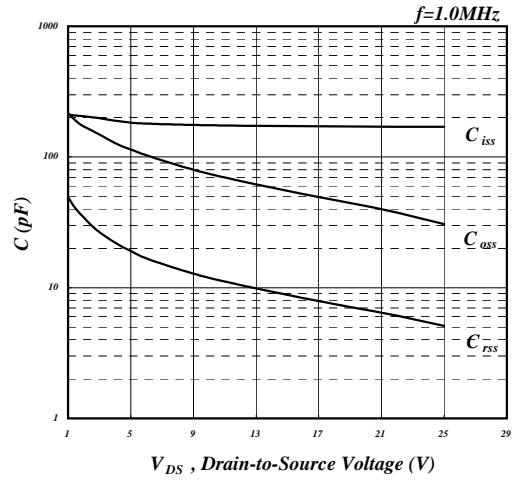

Fig 8. Typical Capacitance Characteristics

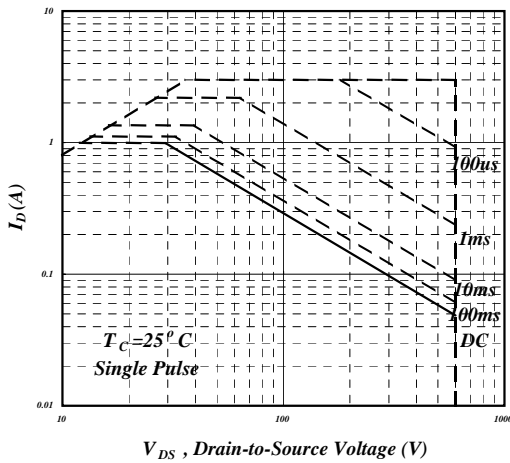

Fig 9. Maximum Safe Operating Area

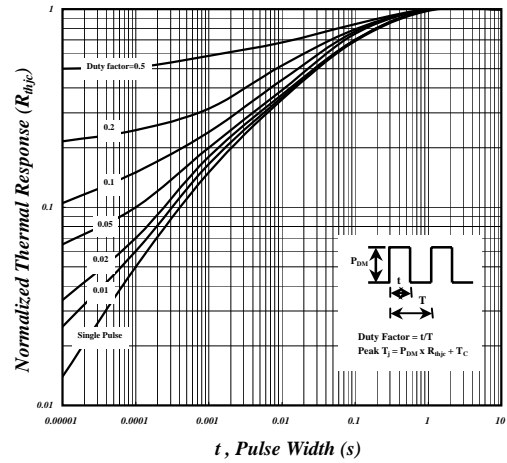

Fig 10. Effective Transient Thermal Impedance

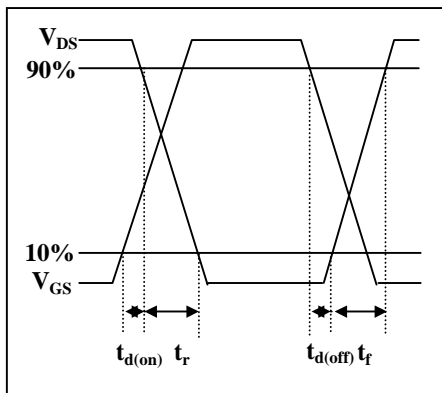

Fig 11. Switching Time Waveform

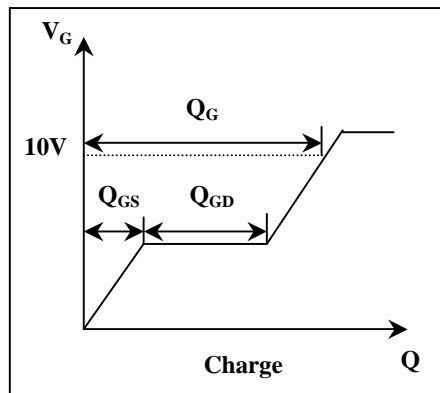
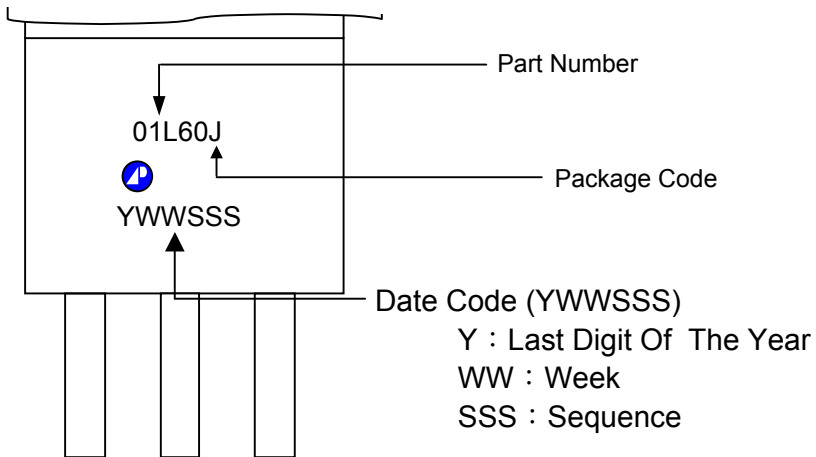

Fig 12. Gate Charge Waveform



MARKING INFORMATION

TO-251



TO-252

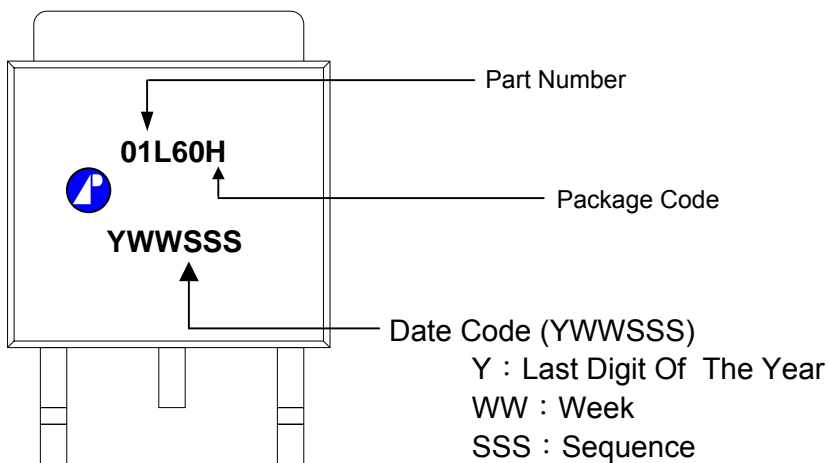



Package Outline : TO-251

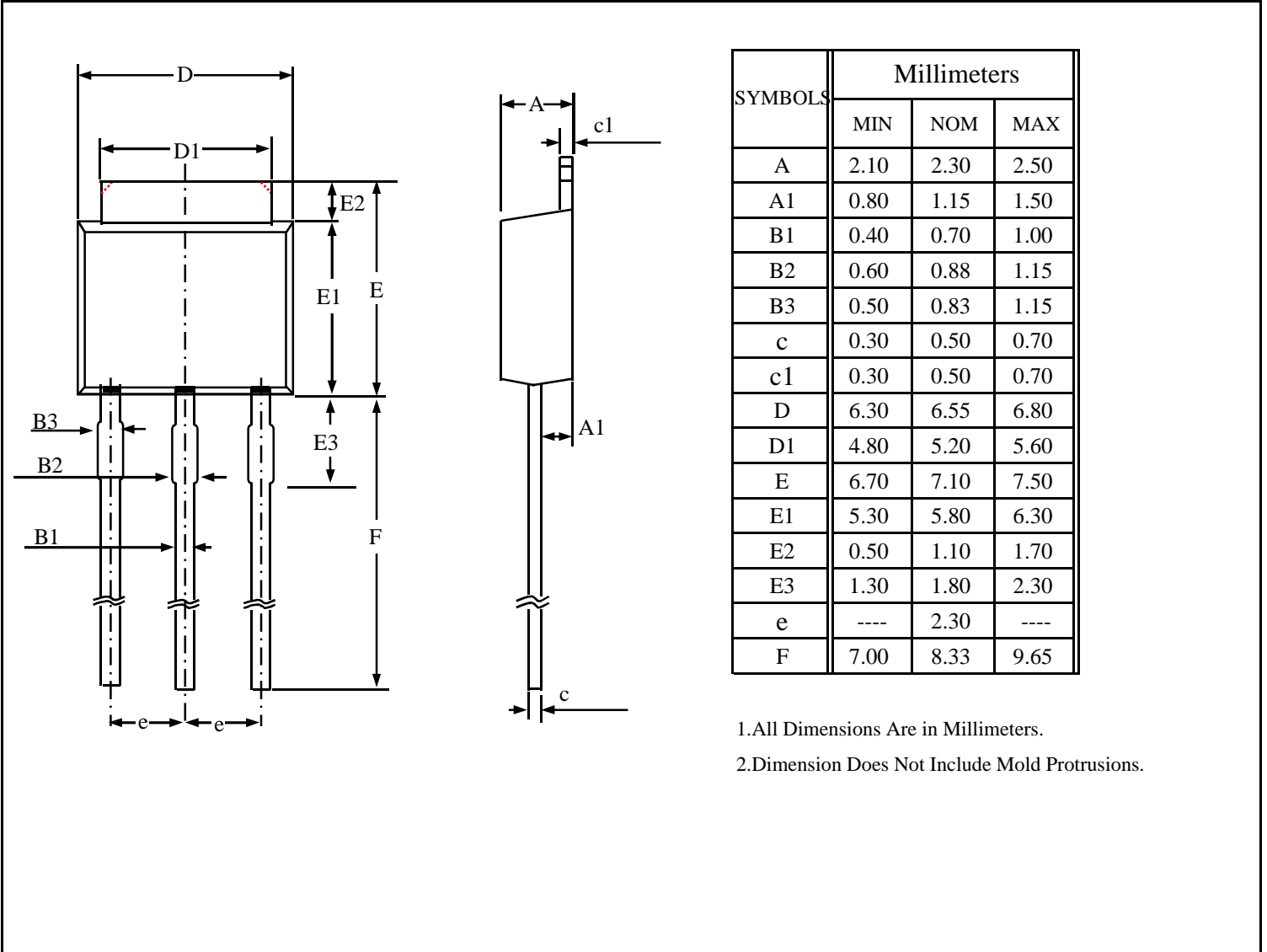

| SYMBOLS | Millimeters | | |
|---------|-------------|------|------|
| | MIN | NOM | MAX |
| A | 2.10 | 2.30 | 2.50 |
| A1 | 0.80 | 1.15 | 1.50 |
| B1 | 0.40 | 0.70 | 1.00 |
| B2 | 0.60 | 0.88 | 1.15 |
| B3 | 0.50 | 0.83 | 1.15 |
| c | 0.30 | 0.50 | 0.70 |
| c1 | 0.30 | 0.50 | 0.70 |
| D | 6.30 | 6.55 | 6.80 |
| D1 | 4.80 | 5.20 | 5.60 |
| E | 6.70 | 7.10 | 7.50 |
| E1 | 5.30 | 5.80 | 6.30 |
| E2 | 0.50 | 1.10 | 1.70 |
| E3 | 1.30 | 1.80 | 2.30 |
| e | ---- | 2.30 | ---- |
| F | 7.00 | 8.33 | 9.65 |

1.All Dimensions Are in Millimeters.

2.Dimension Does Not Include Mold Protrusions.



TO-251 FOOTPRINT :

