

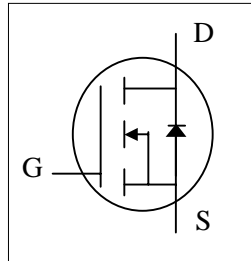

- ▼ Simple Drive Requirement
- ▼ Isolation Full Package
- ▼ Fast Switching Characteristics
- ▼ RoHS Compliant & Halogen-Free



BV_{DSS}	900V
$R_{DS(ON)}$	7.2 Ω
I_D	1.9A

Description

AP02N90 series are from Advanced Power innovated design and silicon process technology to achieve the lowest possible on-resistance and fast switching performance. It provides the designer with an extreme efficient device for use in a wide range of power applications.

The TO-220CFM package is widely preferred for all commercial-industrial through hole applications. The mold compound provides a high isolation voltage capability and low thermal resistance between the tab and the external heat-sink.

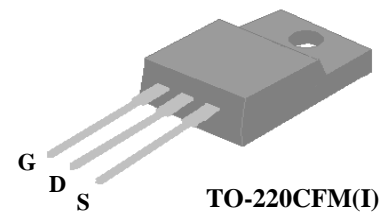

Absolute Maximum Ratings @ $T_J=25^\circ\text{C}$ (unless otherwise specified)

Symbol	Parameter	Rating	Units
V_{DS}	Drain-Source Voltage	900	V
V_{GS}	Gate-Source Voltage	+30	V
$I_D@T_C=25^\circ\text{C}$	Drain Current, V_{GS} @ 10V	1.9	A
$I_D@T_C=100^\circ\text{C}$	Drain Current, V_{GS} @ 10V	1.2	A
I_{DM}	Pulsed Drain Current ¹	6	A
$P_D@T_C=25^\circ\text{C}$	Total Power Dissipation	34.7	W
	Linear Derating Factor	0.28	W/ $^\circ\text{C}$
E_{AS}	Single Pulse Avalanche Energy ²	18	mJ
I_{AR}	Avalanche Current	1.9	A
T_{STG}	Storage Temperature Range	-55 to 150	$^\circ\text{C}$
T_J	Operating Junction Temperature Range	-55 to 150	$^\circ\text{C}$

Thermal Data

Symbol	Parameter	Value	Units
R_{thj-c}	Maximum Thermal Resistance, Junction-case	3.6	$^\circ\text{C}/\text{W}$
R_{thj-a}	Maximum Thermal Resistance, Junction-ambient	62	$^\circ\text{C}/\text{W}$



AP02N90I-HF

Electrical Characteristics @ $T_j=25^\circ\text{C}$ (unless otherwise specified)

Symbol	Parameter	Test Conditions	Min.	Typ.	Max.	Units
BV_{DSS}	Drain-Source Breakdown Voltage	$V_{GS}=0V, I_D=1mA$	900	-	-	V
$\Delta BV_{DSS}/\Delta T_j$	Breakdown Voltage Temperature Coefficient	Reference to $25^\circ\text{C}, I_D=1mA$	-	0.8	-	$V/^\circ\text{C}$
$R_{DS(ON)}$	Static Drain-Source On-Resistance	$V_{GS}=10V, I_D=0.85A$	-	-	7.2	Ω
$V_{GS(th)}$	Gate Threshold Voltage	$V_{DS}=V_{GS}, I_D=250\mu A$	2	-	4	V
g_{fs}	Forward Transconductance	$V_{DS}=10V, I_D=1.9A$	-	2	-	S
I_{DSS}	Drain-Source Leakage Current	$V_{DS}=900V, V_{GS}=0V$	-	-	10	μA
	Drain-Source Leakage Current ($T_j=125^\circ\text{C}$)	$V_{DS}=720V, V_{GS}=0V$	-	-	100	μA
I_{GSS}	Gate-Source Leakage	$V_{GS}=\pm 30V, V_{DS}=0V$	-	-	± 100	nA
Q_g	Total Gate Charge ³	$I_D=1.9A$	-	12	20	nC
Q_{gs}	Gate-Source Charge	$V_{DS}=540V$	-	2.5	-	nC
Q_{gd}	Gate-Drain ("Miller") Charge	$V_{GS}=10V$	-	4.7	-	nC
$t_{d(on)}$	Turn-on Delay Time ³	$V_{DD}=450V$	-	10	-	ns
t_r	Rise Time	$I_D=1.9A$	-	5	-	ns
$t_{d(off)}$	Turn-off Delay Time	$R_G=10\Omega$	-	18	-	ns
t_f	Fall Time	$V_{GS}=10V$	-	9	-	ns
C_{iss}	Input Capacitance	$V_{GS}=0V$	-	630	1000	pF
C_{oss}	Output Capacitance	$V_{DS}=25V$	-	40	-	pF
C_{rss}	Reverse Transfer Capacitance	$f=1.0MHz$	-	4	-	pF

Source-Drain Diode

Symbol	Parameter	Test Conditions	Min.	Typ.	Max.	Units
V_{SD}	Forward On Voltage ³	$I_S=1.9A, V_{GS}=0V$	-	-	1.3	V
t_{rr}	Reverse Recovery Time	$I_S=1.9A, V_{GS}=0V,$	-	360	-	ns
Q_{rr}	Reverse Recovery Charge	$dI/dt=100A/\mu s$	-	1.8	-	μC

Notes:

1. Pulse width limited by maximum junction temperature.
2. Starting $T_j=25^\circ\text{C}$, $V_{DD}=50V$, $L=10mH$, $R_G=25\Omega$, $I_{AS}=1.9A$.
3. Pulse test

THIS PRODUCT IS SENSITIVE TO ELECTROSTATIC DISCHARGE, PLEASE HANDLE WITH CAUTION.

USE OF THIS PRODUCT AS A CRITICAL COMPONENT IN LIFE SUPPORT OR OTHER SIMILAR SYSTEMS IS NOT AUTHORIZED.

APEC DOES NOT ASSUME ANY LIABILITY ARISING OUT OF THE APPLICATION OR USE OF ANY PRODUCT OR CIRCUIT DESCRIBED HEREIN; NEITHER DOES IT CONVEY ANY LICENSE UNDER ITS PATENT RIGHTS, NOR THE RIGHTS OF OTHERS.

APEC RESERVES THE RIGHT TO MAKE CHANGES WITHOUT FURTHER NOTICE TO ANY PRODUCTS HEREIN TO IMPROVE RELIABILITY, FUNCTION OR DESIGN.

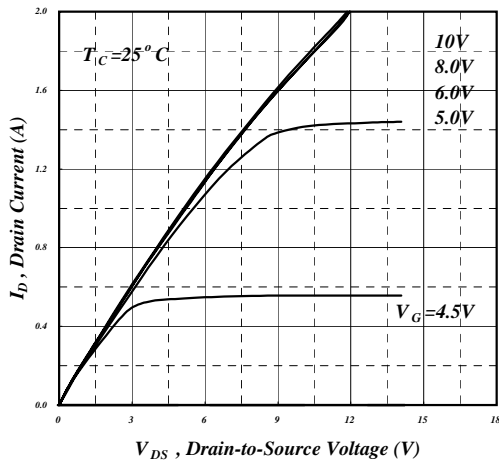

Fig 1. Typical Output Characteristics

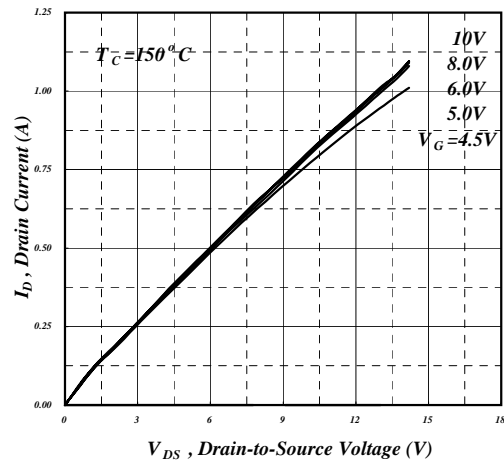

Fig 2. Typical Output Characteristics

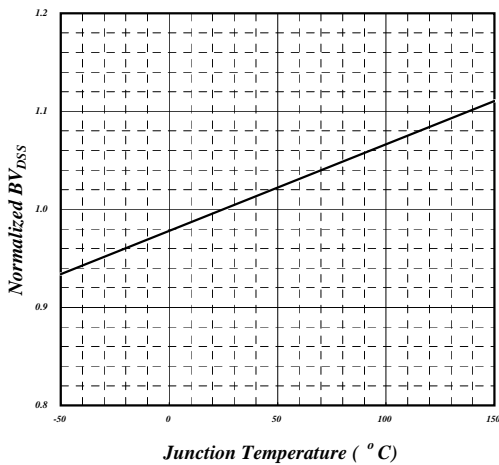

Fig 3. Normalized BV_{DSS} v.s. Junction Temperature

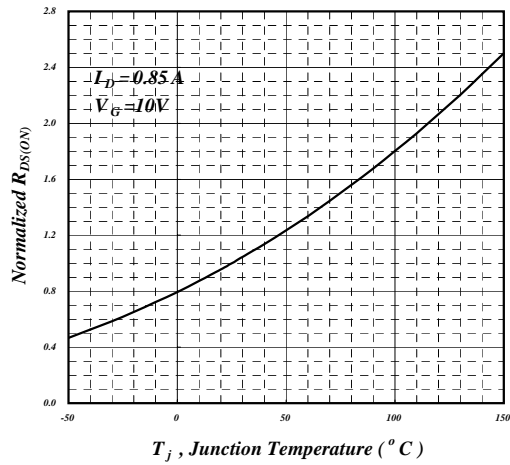

Fig 4. Normalized On-Resistance v.s. Junction Temperature

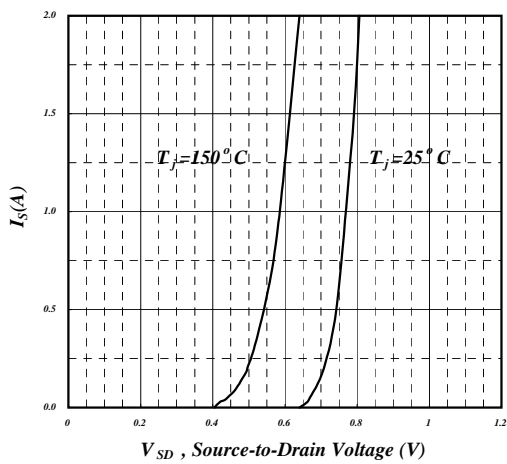

Fig 5. Forward Characteristic of Reverse Diode

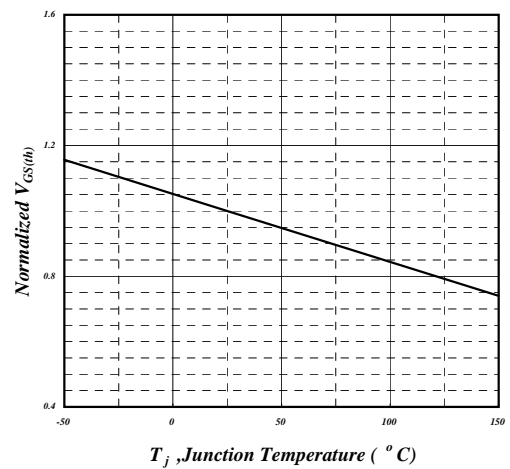

Fig 6. Gate Threshold Voltage v.s. Junction Temperature

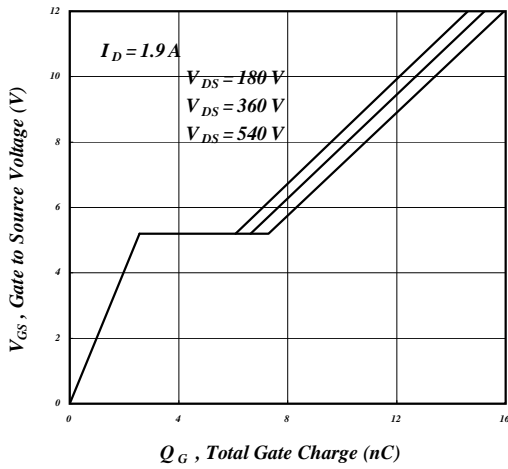

Fig 7. Gate Charge Characteristics

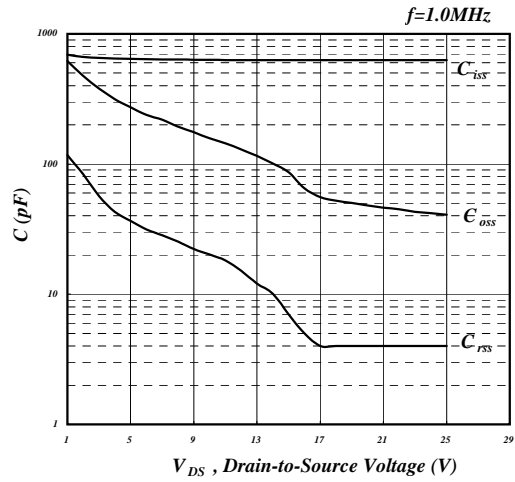

Fig 8. Typical Capacitance Characteristics

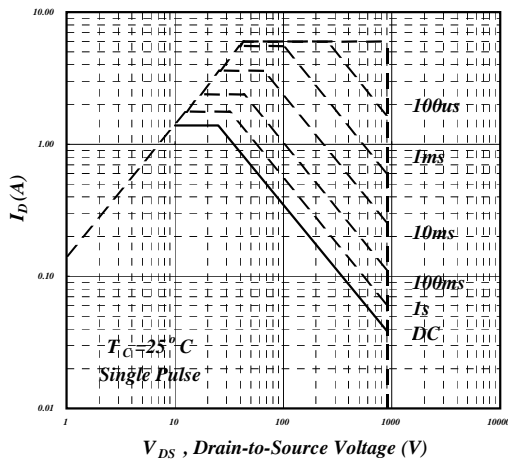

Fig 9. Maximum Safe Operating Area

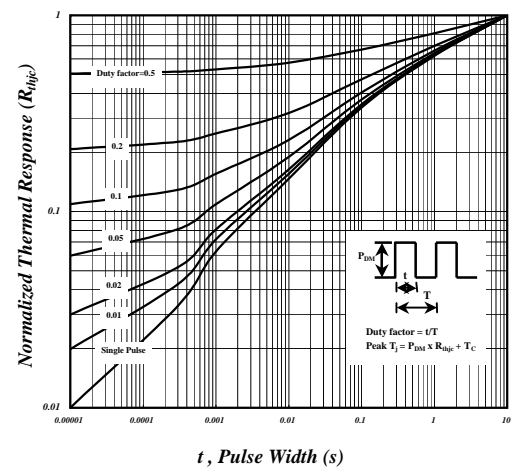

Fig 10. Effective Transient Thermal Impedance

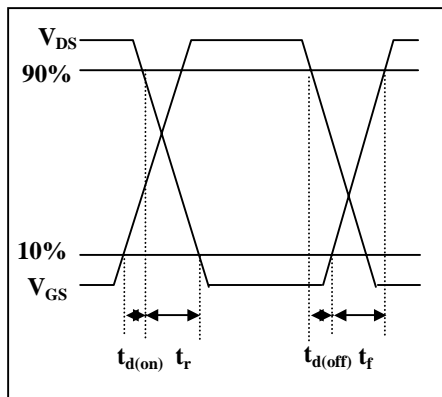

Fig 11. Switching Time Waveform

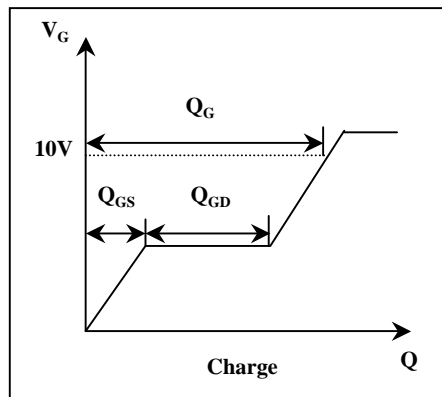
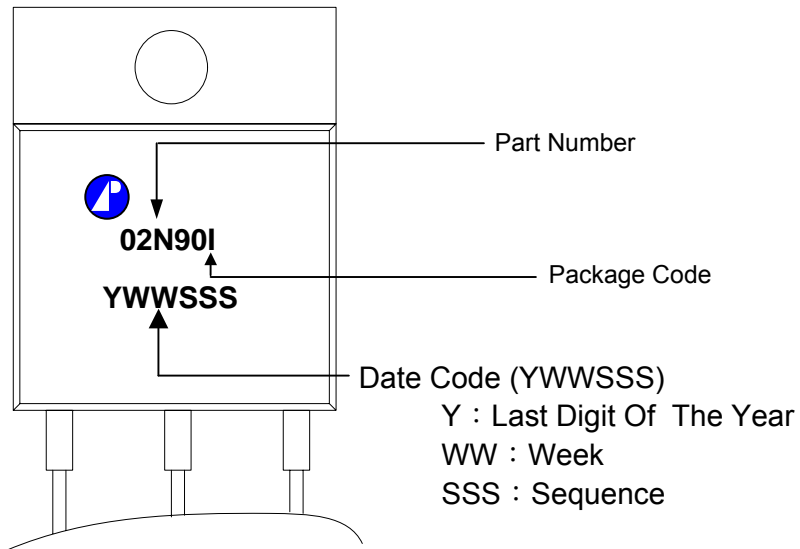

Fig 12. Gate Charge Waveform



MARKING INFORMATION





Package Outline : TO-220CFM

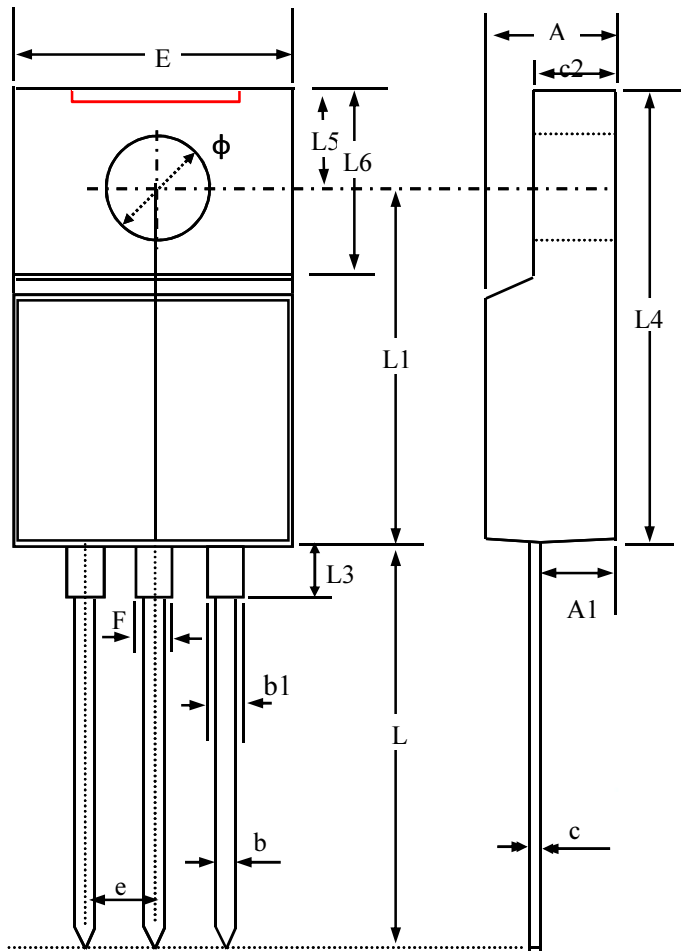

SYMBOLS	Millimeters		
	MIN	NOM	MAX
A	4.20	4.55	4.90
A1	1.90	2.45	3.00
b	0.50	0.80	1.10
b1	0.85	1.18	1.50
c	0.30	0.65	1.00
c2	2.30	2.60	3.10
E	9.70	10.25	10.80
L	12.00	13.50	15.00
L1	11.50	12.25	13.00
L3	2.82	3.37	3.92
L4	14.70	15.60	16.50
L5	2.30	3.10	3.90
L6	6.20	6.85	7.50
ϕ	3.00	3.20	3.40
e	2.40	2.55	2.70
F	0.80	1.35	1.90

1. All Dimensions Are in Millimeters.
2. Dimension Does Not Include Mold Protrusions.



TO-220CFM FOOTPRINT :

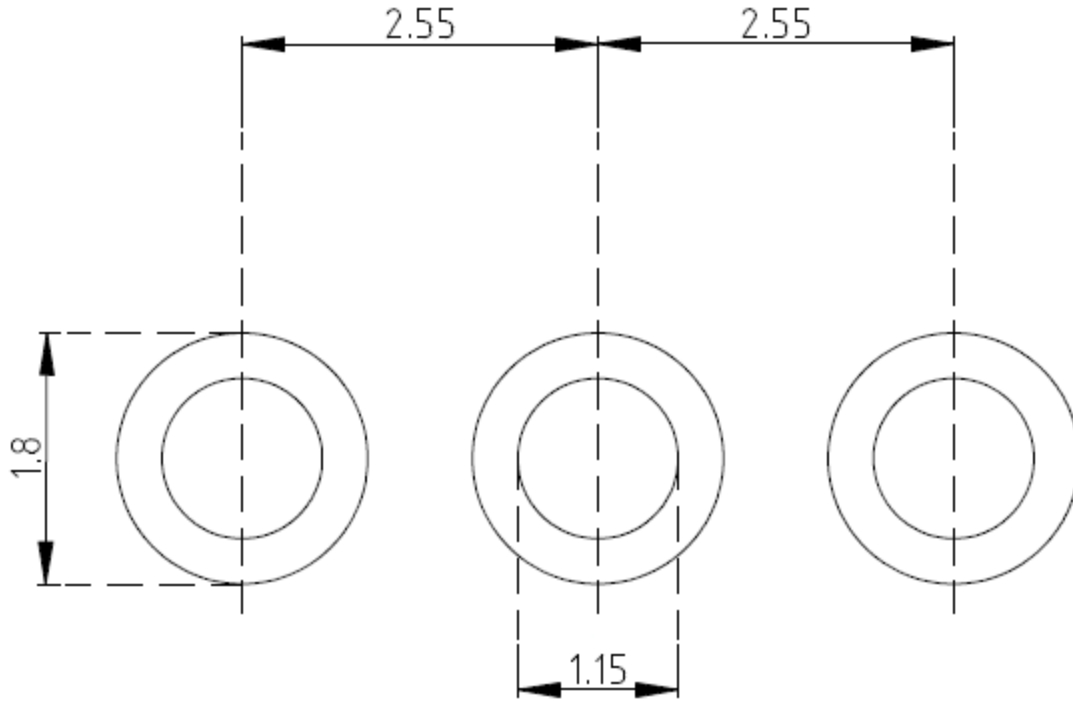

UNIT: mm