

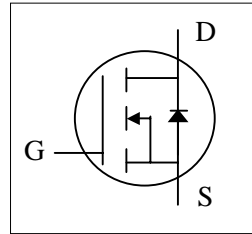

- ▼ **100% Avalanche Rated**
- ▼ **Fast Switching**
- ▼ **Simple Drive Requirement**



$BV_{DSS}$	600V
$R_{DS(ON)}$	0.75 $\Omega$
$I_D$	9A

### Description

AP09N70 series are from Advanced Power innovated design and silicon process technology to achieve the lowest possible on-resistance and fast switching performance. It provides the designer with an extreme efficient device for use in a wide range of power applications.

The TO-262 package is widely preferred for commercial-industrial through-hole applications and suited for low voltage applications such as DC/DC converters.

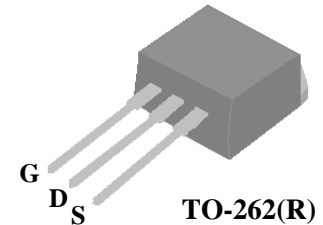

### Absolute Maximum Ratings @ $T_j=25^\circ\text{C}$ (unless otherwise specified)

Symbol	Parameter	Rating	Units
$V_{DS}$	Drain-Source Voltage	600	V
$V_{GS}$	Gate-Source Voltage	$\pm 30$	V
$I_D @ T_C=25^\circ\text{C}$	Drain Current, $V_{GS} @ 10\text{V}$	9	A
$I_D @ T_C=100^\circ\text{C}$	Drain Current, $V_{GS} @ 10\text{V}$	5	A
$I_{DM}$	Pulsed Drain Current <sup>1</sup>	40	A
$P_D @ T_C=25^\circ\text{C}$	Total Power Dissipation	156	W
$E_{AS}$	Single Pulse Avalanche Energy <sup>2</sup>	305	mJ
$T_{STG}$	Storage Temperature Range	-55 to 150	$^\circ\text{C}$
$T_J$	Operating Junction Temperature Range	-55 to 150	$^\circ\text{C}$

### Thermal Data

Symbol	Parameter	Value	Unit
Rthj-c	Maximum Thermal Resistance, Junction-case	0.8	$^\circ\text{C}/\text{W}$
Rthj-a	Maximum Thermal Resistance, Junction-ambient	62	$^\circ\text{C}/\text{W}$



**Electrical Characteristics @T<sub>j</sub>=25°C(unless otherwise specified)**

Symbol	Parameter	Test Conditions	Min.	Typ.	Max.	Units
BV <sub>DSS</sub>	Drain-Source Breakdown Voltage	V <sub>GS</sub> =0V, I <sub>D</sub> =1mA	600	-	-	V
R <sub>DS(ON)</sub>	Static Drain-Source On-Resistance <sup>3</sup>	V <sub>GS</sub> =10V, I <sub>D</sub> =4.5A	-	-	0.75	Ω
V <sub>GS(th)</sub>	Gate Threshold Voltage	V <sub>DS</sub> =V <sub>GS</sub> , I <sub>D</sub> =250uA	2	-	4	V
g <sub>fs</sub>	Forward Transconductance	V <sub>DS</sub> =10V, I <sub>D</sub> =4.5A	-	4.5	-	S
I <sub>DSS</sub>	Drain-Source Leakage Current	V <sub>DS</sub> =480V, V <sub>GS</sub> =0V	-	-	100	uA
I <sub>GSS</sub>	Gate-Source Leakage	V <sub>GS</sub> =±30V, V <sub>DS</sub> =0V	-	-	±100	nA
Q <sub>g</sub>	Total Gate Charge <sup>3</sup>	I <sub>D</sub> =9A	-	44	-	nC
Q <sub>gs</sub>	Gate-Source Charge	V <sub>DS</sub> =480V	-	11	-	nC
Q <sub>gd</sub>	Gate-Drain ("Miller") Charge	V <sub>GS</sub> =10V	-	12	-	nC
t <sub>d(on)</sub>	Turn-on Delay Time <sup>3</sup>	V <sub>DD</sub> =300V	-	19	-	ns
t <sub>r</sub>	Rise Time	I <sub>D</sub> =9A	-	21	-	ns
t <sub>d(off)</sub>	Turn-off Delay Time	R <sub>G</sub> =10Ω	-	56	-	ns
t <sub>f</sub>	Fall Time	V <sub>GS</sub> =10V	-	24	-	ns
C <sub>iss</sub>	Input Capacitance	V <sub>GS</sub> =0V	-	2660	-	pF
C <sub>oss</sub>	Output Capacitance	V <sub>DS</sub> =25V	-	170	-	pF
C <sub>rss</sub>	Reverse Transfer Capacitance	f=1.0MHz	-	10	-	pF

**Source-Drain Diode**

Symbol	Parameter	Test Conditions	Min.	Typ.	Max.	Units
I <sub>S</sub>	Continuous Source Current ( Body Diode )	V <sub>D</sub> =V <sub>G</sub> =0V , V <sub>S</sub> =1.5V	-	-	9	A
I <sub>SM</sub>	Pulsed Source Current ( Body Diode ) <sup>1</sup>		-	-	40	A
V <sub>SD</sub>	Forward On Voltage <sup>3</sup>	T <sub>j</sub> =25°C , I <sub>S</sub> =9A, V <sub>GS</sub> =0V	-	-	1.5	V

**Notes:**

- 1.Pulse width limited by Maximum junction temperature.
- 2.Starting T<sub>j</sub>=25°C , V<sub>DD</sub>=50V , L=6.8mH , R<sub>G</sub>=25Ω
- 3.Pulse test

THIS PRODUCT IS SENSITIVE TO ELECTROSTATIC DISCHARGE, PLEASE HANDLE WITH CAUTION.

USE OF THIS PRODUCT AS A CRITICAL COMPONENT IN LIFE SUPPORT OR OTHER SIMILAR SYSTEMS IS NOT AUTHORIZED.

APEC DOES NOT ASSUME ANY LIABILITY ARISING OUT OF THE APPLICATION OR USE OF ANY PRODUCT OR CIRCUIT DESCRIBED HEREIN; NEITHER DOES IT CONVEY ANY LICENSE UNDER ITS PATENT RIGHTS, NOR THE RIGHTS OF OTHERS.

APEC RESERVES THE RIGHT TO MAKE CHANGES WITHOUT FURTHER NOTICE TO ANY PRODUCTS HEREIN TO IMPROVE RELIABILITY, FUNCTION OR DESIGN.

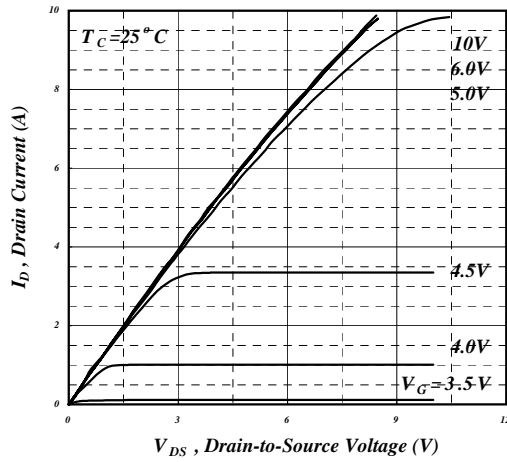

Fig 1. Typical Output Characteristics

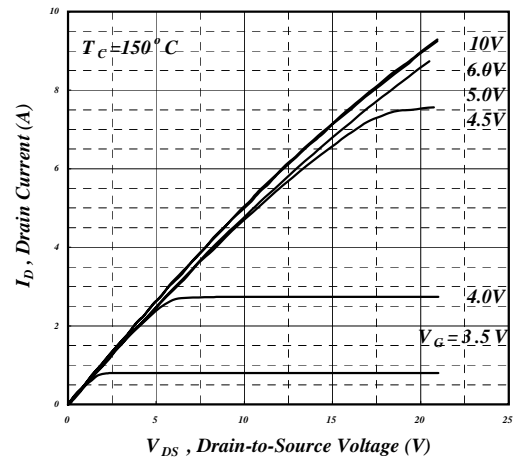

Fig 2. Typical Output Characteristics

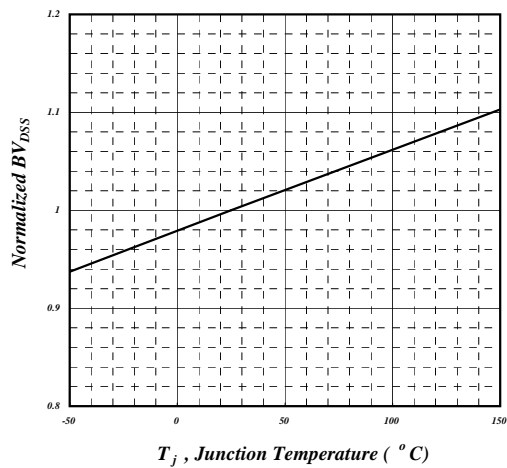

Fig 3. Normalized  $BV_{DSS}$  v.s. Junction Temperature

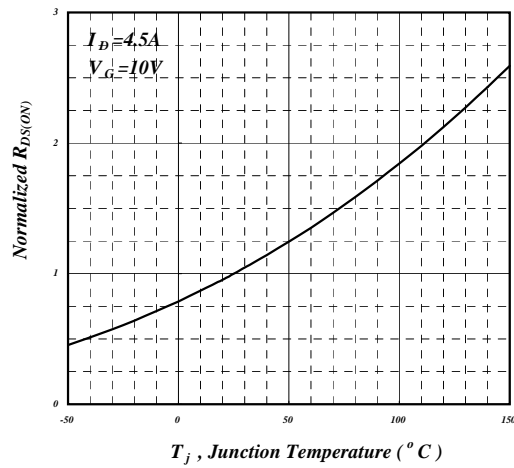

Fig 4. Normalized On-Resistance v.s. Junction Temperature

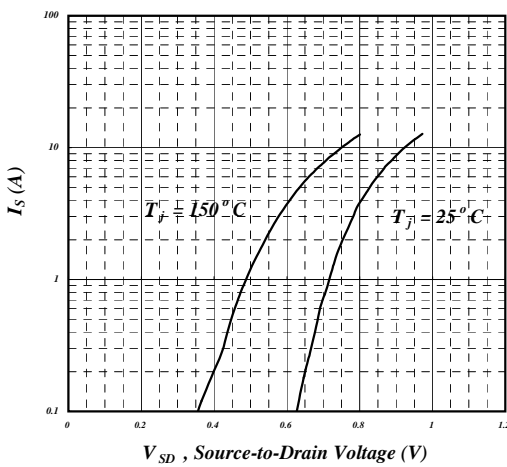

Fig 5. Forward Characteristic of Reverse Diode

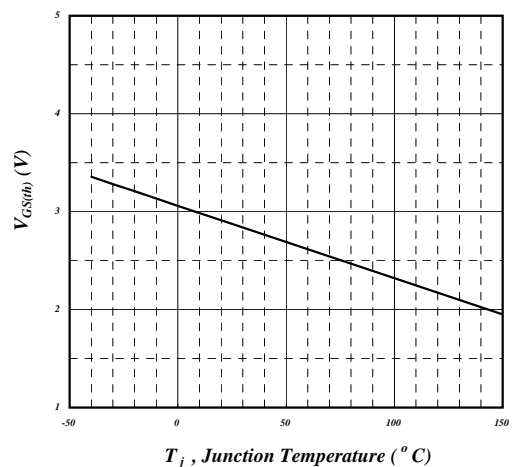

Fig 6. Gate Threshold Voltage v.s. Junction Temperature

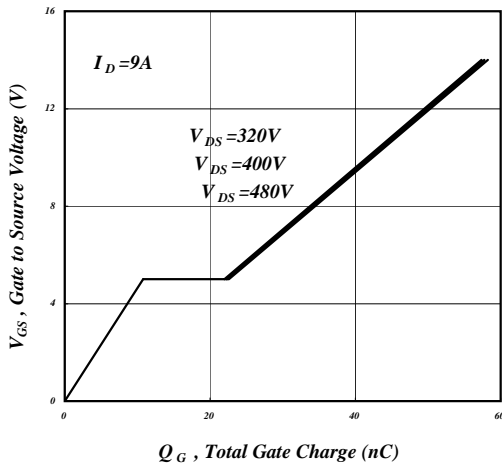

Fig 7. Gate Charge Characteristics

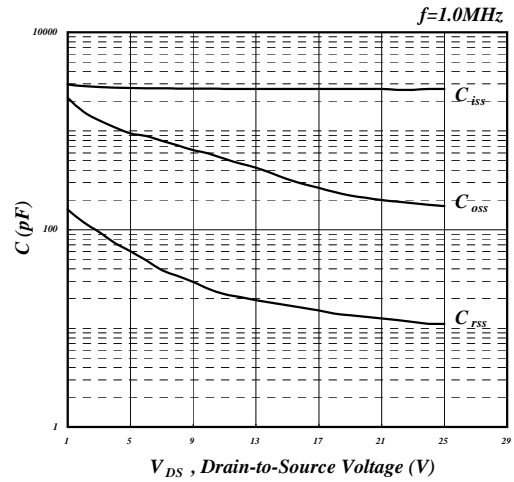

Fig 8. Typical Capacitance Characteristics

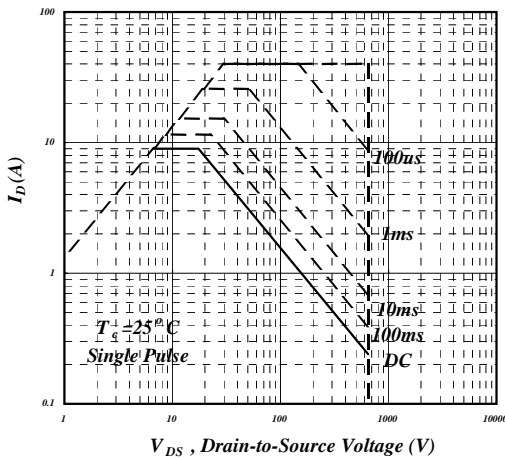

Fig 9. Maximum Safe Operating Area

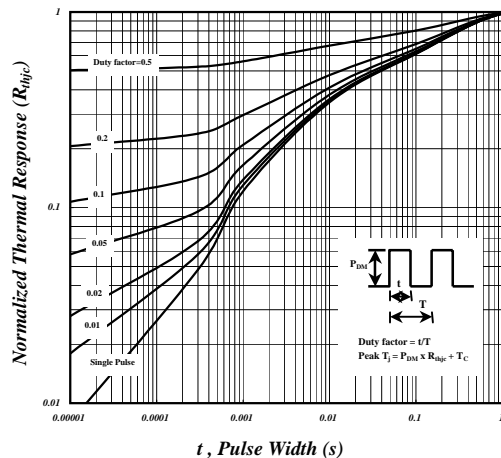

Fig 10. Effective Transient Thermal Impedance



Fig 11. Switching Time Waveform

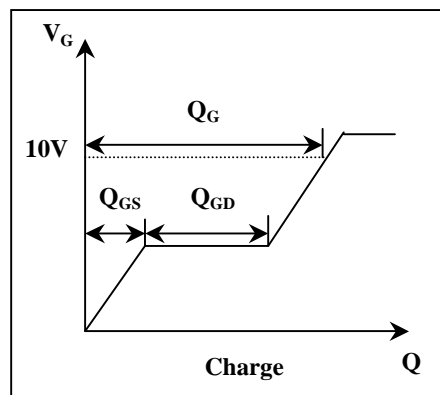
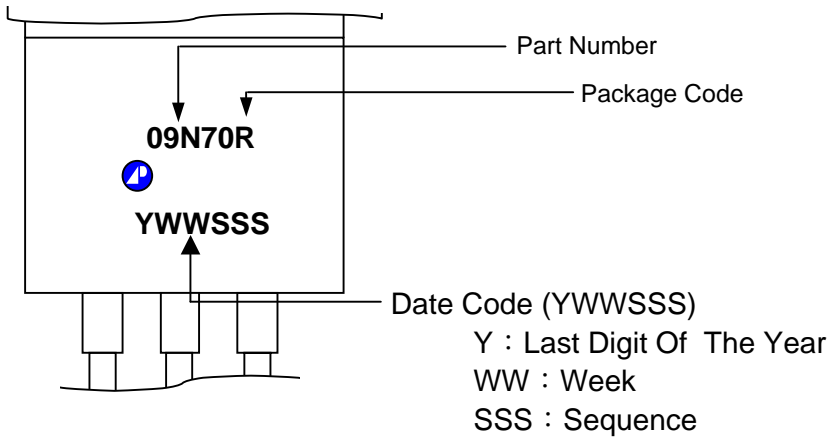

Fig 12. Gate Charge Waveform



## MARKING INFORMATION





## Package Outline : TO-262

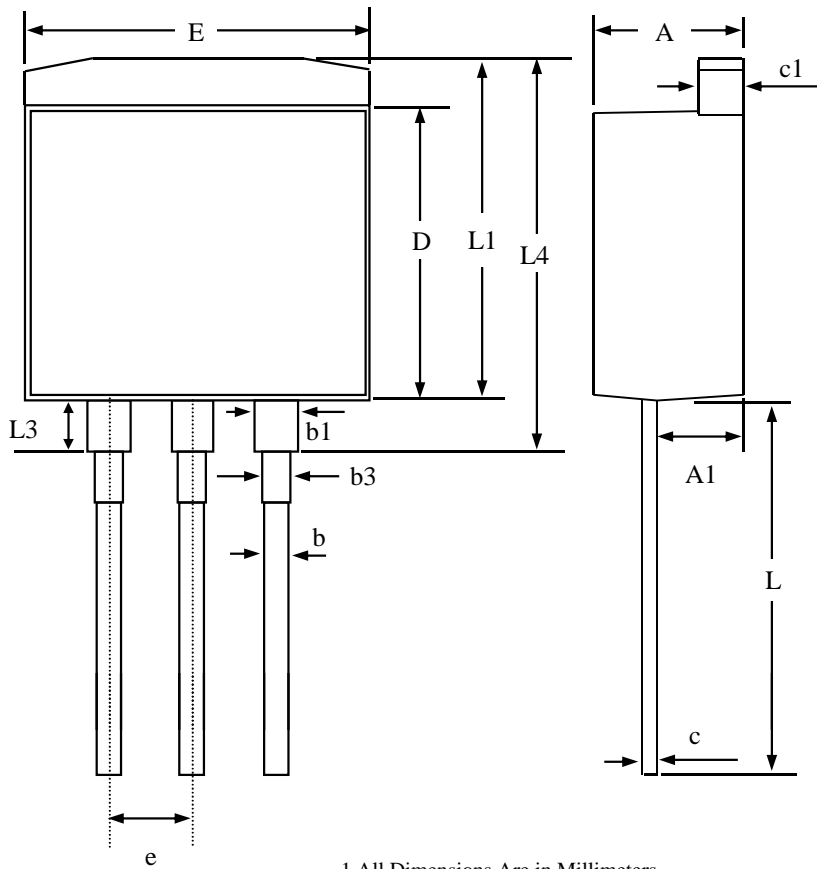

SYMBOLS	Millimeters		
	MIN	NOM	MAX
A	4.24	4.54	4.84
A1	2.10	2.50	2.90
b	0.65	0.85	1.05
b1	0.63	1.08	1.53
b3	0.75	1.08	1.40
c	0.30	0.45	0.60
c1	1.15	1.3	1.45
D	8.30	8.9	9.50
E	9.50	10	10.50
e	2.04	2.54	3.04
L	10.50	12.5	14.50
L1	8.50	10	11.50
L3	1.3 ~ 4.8 (ref)		

1. All Dimensions Are in Millimeters.
2. Dimension Does Not Include Mold Protrusions.



**TO-262 FOOTPRINT :**

