

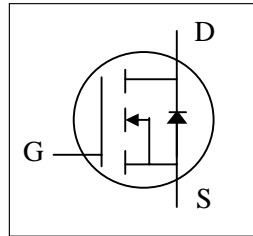

- ▼ 100% R<sub>g</sub> & UIS Test
- ▼ Simple Drive Requirement
- ▼ Lower On-resistance
- ▼ RoHS Compliant & Halogen-Free



BV <sub>DSS</sub>	100V
R <sub>DS(ON)</sub>	12.5mΩ
I <sub>D</sub>	48A

### Description

AP10N012 series are from Advanced Power innovated design and silicon process technology to achieve the lowest possible on-resistance and fast switching performance. It provides the designer with an extreme efficient device for use in a wide range of power applications.

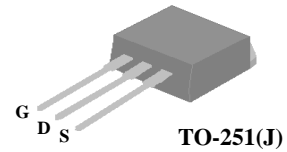

The straight lead version TO-251 package is widely preferred for all commercial-industrial through hole applications.

### Absolute Maximum Ratings @T<sub>j</sub>=25°C(unless otherwise specified)

Symbol	Parameter	Rating	Units
V <sub>DS</sub>	Drain-Source Voltage	100	V
V <sub>GS</sub>	Gate-Source Voltage	+20	V
I <sub>D</sub> @T <sub>C</sub> =25°C	Drain Current, V <sub>GS</sub> @ 10V	48	A
I <sub>D</sub> @T <sub>C</sub> =100°C	Drain Current, V <sub>GS</sub> @ 10V	30	A
I <sub>DM</sub>	Pulsed Drain Current <sup>1</sup>	160	A
P <sub>D</sub> @T <sub>C</sub> =25°C	Total Power Dissipation	52	W
P <sub>D</sub> @T <sub>A</sub> =25°C	Total Power Dissipation	1.13	W
E <sub>AS</sub>	Single Pulse Avalanche Energy <sup>3</sup>	128	mJ
T <sub>STG</sub>	Storage Temperature Range	-55 to 150	°C
T <sub>J</sub>	Operating Junction Temperature Range	-55 to 150	°C

### Thermal Data

Symbol	Parameter	Value	Units
R <sub>thj-c</sub>	Maximum Thermal Resistance, Junction-case	2.4	°C/W
R <sub>thj-a</sub>	Maximum Thermal Resistance, Junction-ambient	110	°C/W



# AP10N012J

## Electrical Characteristics @T<sub>j</sub>=25°C(unless otherwise specified)

Symbol	Parameter	Test Conditions	Min.	Typ.	Max.	Units
BV <sub>DSS</sub>	Drain-Source Breakdown Voltage	V <sub>GS</sub> =0V, I <sub>D</sub> =250uA	100	-	-	V
R <sub>DS(ON)</sub>	Static Drain-Source On-Resistance <sup>2</sup>	V <sub>GS</sub> =10V, I <sub>D</sub> =30A	-	-	12.5	mΩ
V <sub>GS(th)</sub>	Gate Threshold Voltage	V <sub>DS</sub> =V <sub>GS</sub> , I <sub>D</sub> =250uA	2	-	5	V
g <sub>fs</sub>	Forward Transconductance	V <sub>DS</sub> =5V, I <sub>D</sub> =30A	-	30	-	S
I <sub>DSS</sub>	Drain-Source Leakage Current	V <sub>DS</sub> =80V, V <sub>GS</sub> =0V	-	-	25	uA
I <sub>GSS</sub>	Gate-Source Leakage	V <sub>GS</sub> =±20V, V <sub>DS</sub> =0V	-	-	±100	nA
Q <sub>g</sub>	Total Gate Charge	I <sub>D</sub> =30A	-	41	65.6	nC
Q <sub>gs</sub>	Gate-Source Charge	V <sub>DS</sub> =50V	-	14	-	nC
Q <sub>gd</sub>	Gate-Drain ("Miller") Charge	V <sub>GS</sub> =10V	-	16	-	nC
t <sub>d(on)</sub>	Turn-on Delay Time	V <sub>DS</sub> =50V	-	16	-	ns
t <sub>r</sub>	Rise Time	I <sub>D</sub> =30A	-	85	-	ns
t <sub>d(off)</sub>	Turn-off Delay Time	R <sub>G</sub> =7.5 Ω	-	30	-	ns
t <sub>f</sub>	Fall Time	V <sub>GS</sub> =10V	-	70	-	ns
C <sub>iss</sub>	Input Capacitance	V <sub>GS</sub> =0V	-	2250	3600	pF
C <sub>oss</sub>	Output Capacitance	V <sub>DS</sub> =50V	-	710	-	pF
C <sub>rss</sub>	Reverse Transfer Capacitance	f=1.0MHz	-	25	-	pF
R <sub>g</sub>	Gate Resistance	f=1.0MHz	-	1	2	Ω

## Source-Drain Diode

Symbol	Parameter	Test Conditions	Min.	Typ.	Max.	Units
V <sub>SD</sub>	Forward On Voltage <sup>2</sup>	I <sub>S</sub> =30A, V <sub>GS</sub> =0V	-	-	1.3	V
t <sub>rr</sub>	Reverse Recovery Time	I <sub>S</sub> =30A, V <sub>GS</sub> =0V	-	51	-	ns
Q <sub>rr</sub>	Reverse Recovery Charge	di/dt=100A/μs	-	62	-	nC

### Notes:

- 1.Pulse width limited by Max. junction temperature.
- 2.Pulse test
- 3.Starting T<sub>j</sub>=25°C , V<sub>DD</sub>=50V , L=1mH , R<sub>G</sub>=25 Ω , V<sub>GS</sub>=10V

THIS PRODUCT IS SENSITIVE TO ELECTROSTATIC DISCHARGE, PLEASE HANDLE WITH CAUTION.

USE OF THIS PRODUCT AS A CRITICAL COMPONENT IN LIFE SUPPORT OR OTHER SIMILAR SYSTEMS IS NOT AUTHORIZED.

APEC DOES NOT ASSUME ANY LIABILITY ARISING OUT OF THE APPLICATION OR USE OF ANY PRODUCT OR CIRCUIT DESCRIBED HEREIN; NEITHER DOES IT CONVEY ANY LICENSE UNDER ITS PATENT RIGHTS, NOR THE RIGHTS OF OTHERS.

APEC RESERVES THE RIGHT TO MAKE CHANGES WITHOUT FURTHER NOTICE TO ANY PRODUCTS HEREIN TO IMPROVE RELIABILITY, FUNCTION OR DESIGN.

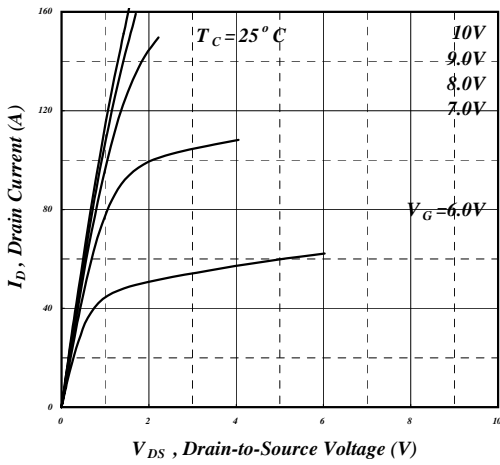

Fig 1. Typical Output Characteristics

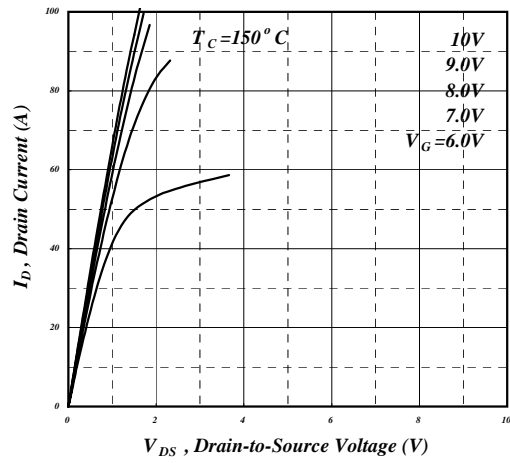

Fig 2. Typical Output Characteristics

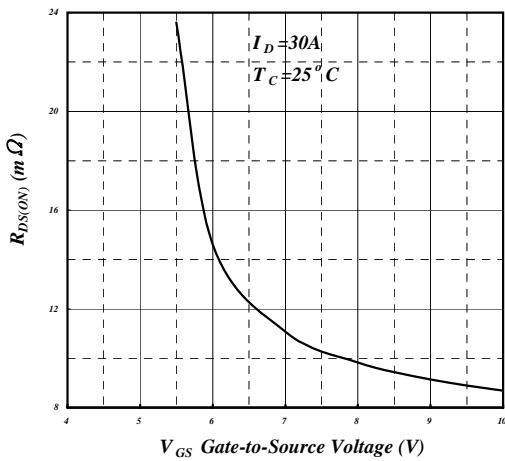

Fig 3. On-Resistance v.s. Gate Voltage

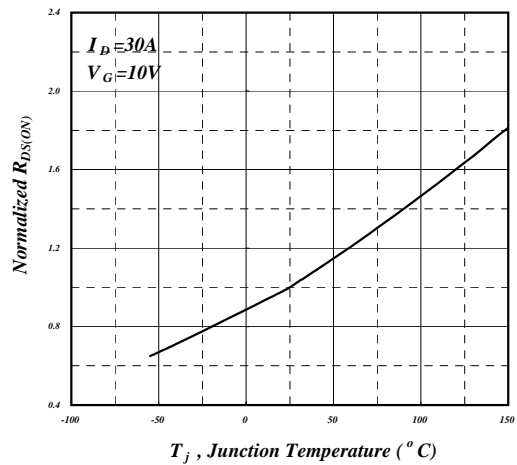

Fig 4. Normalized On-Resistance v.s. Junction Temperature

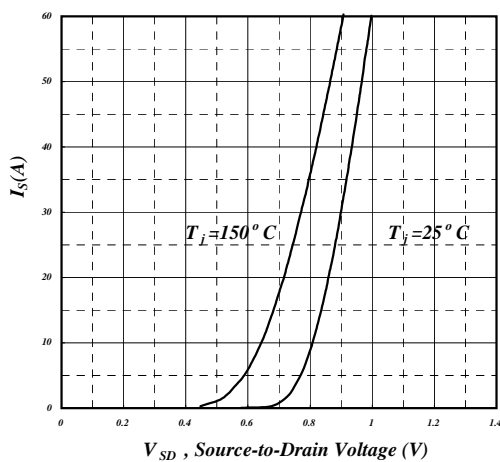

Fig 5. Forward Characteristic of Reverse Diode

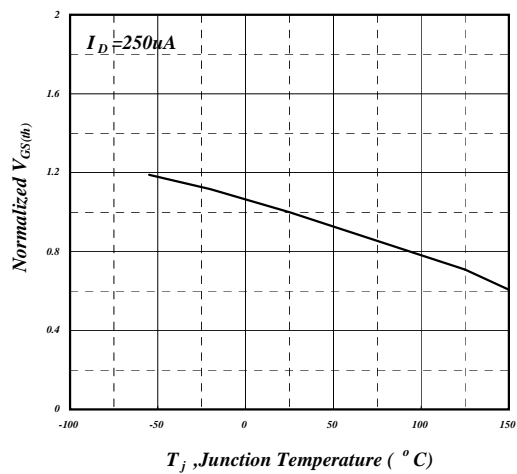

Fig 6. Gate Threshold Voltage v.s. Junction Temperature



# AP10N012J

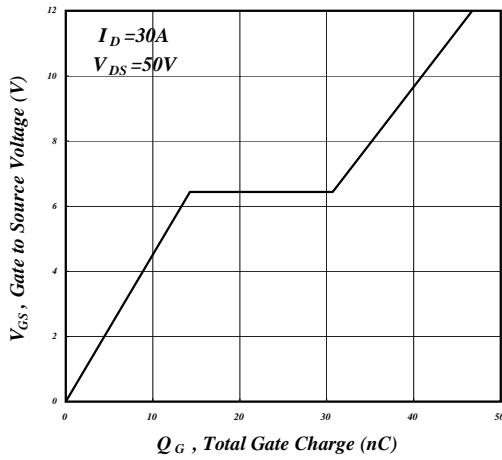

Fig 7. Gate Charge Characteristics

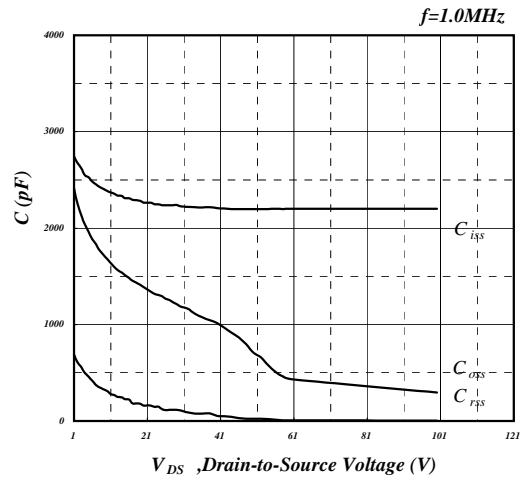

Fig 8. Typical Capacitance Characteristics

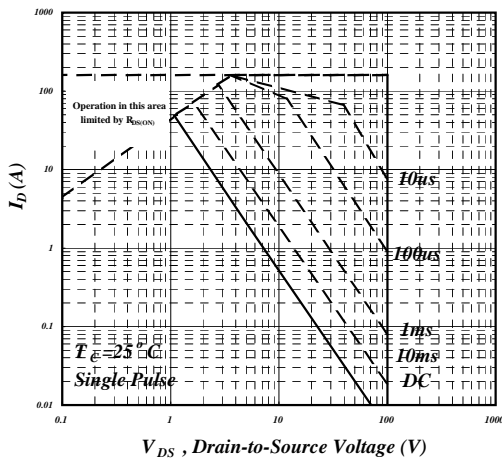

Fig 9. Maximum Safe Operating Area

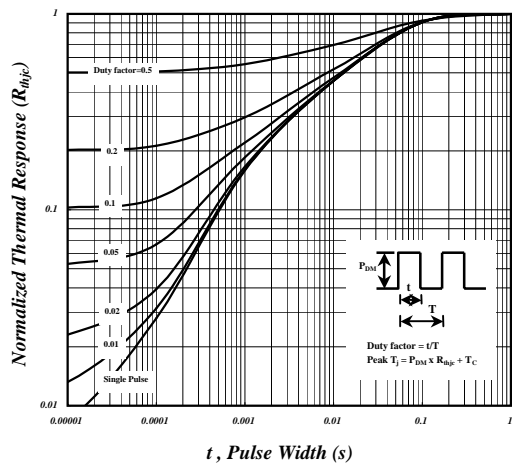

Fig 10. Effective Transient Thermal Impedance

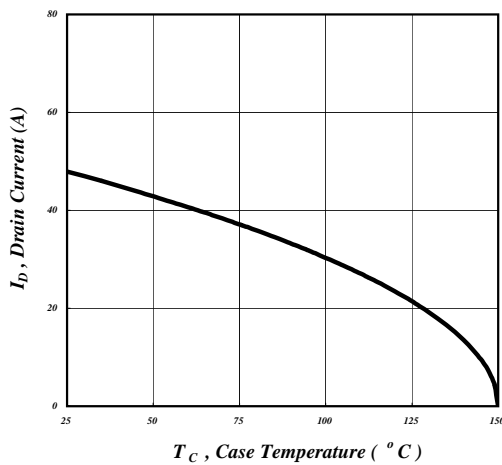

Fig 11. Drain Current v.s. Case Temperature

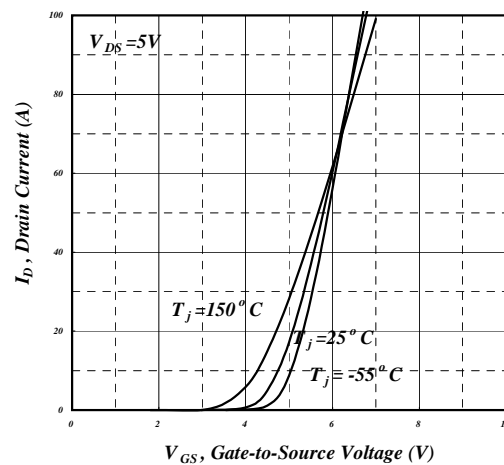

Fig 12. Transfer Characteristics

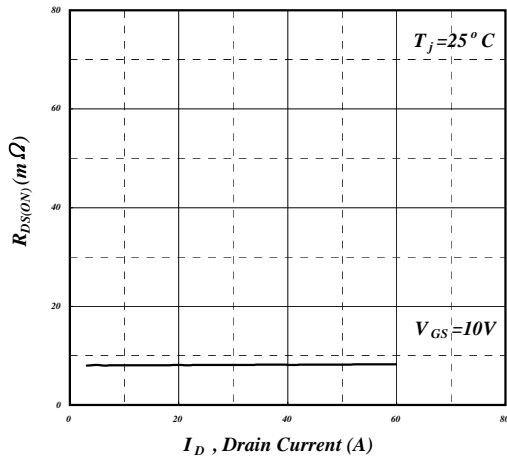

Fig 13. Typ. Drain-Source on State Resistance

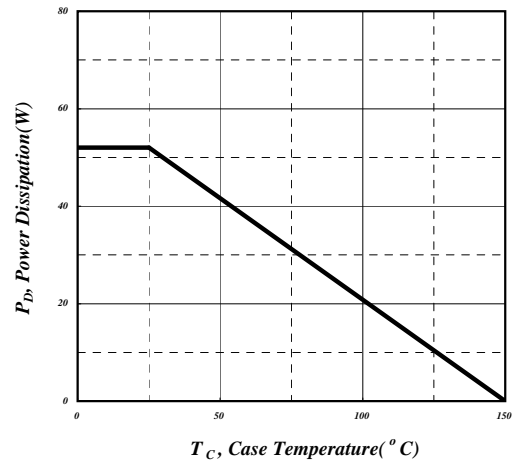

Fig 14. Total Power Dissipation



# AP10N012J

## MARKING INFORMATION

---

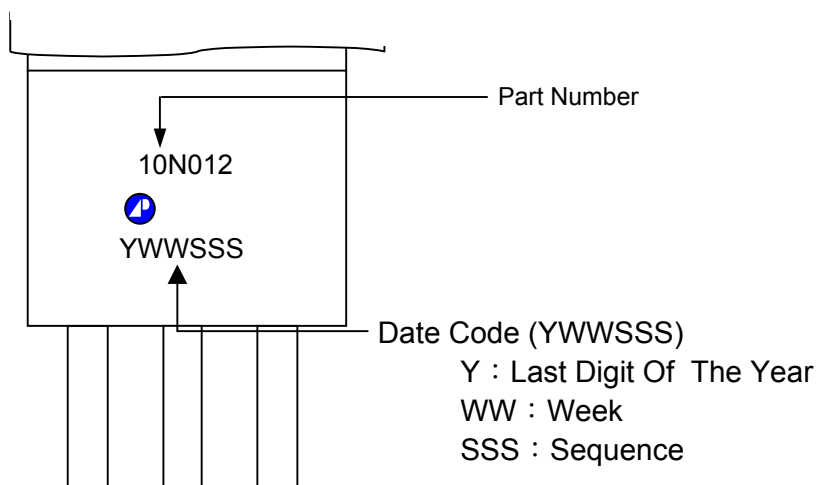



## Package Outline : TO-251

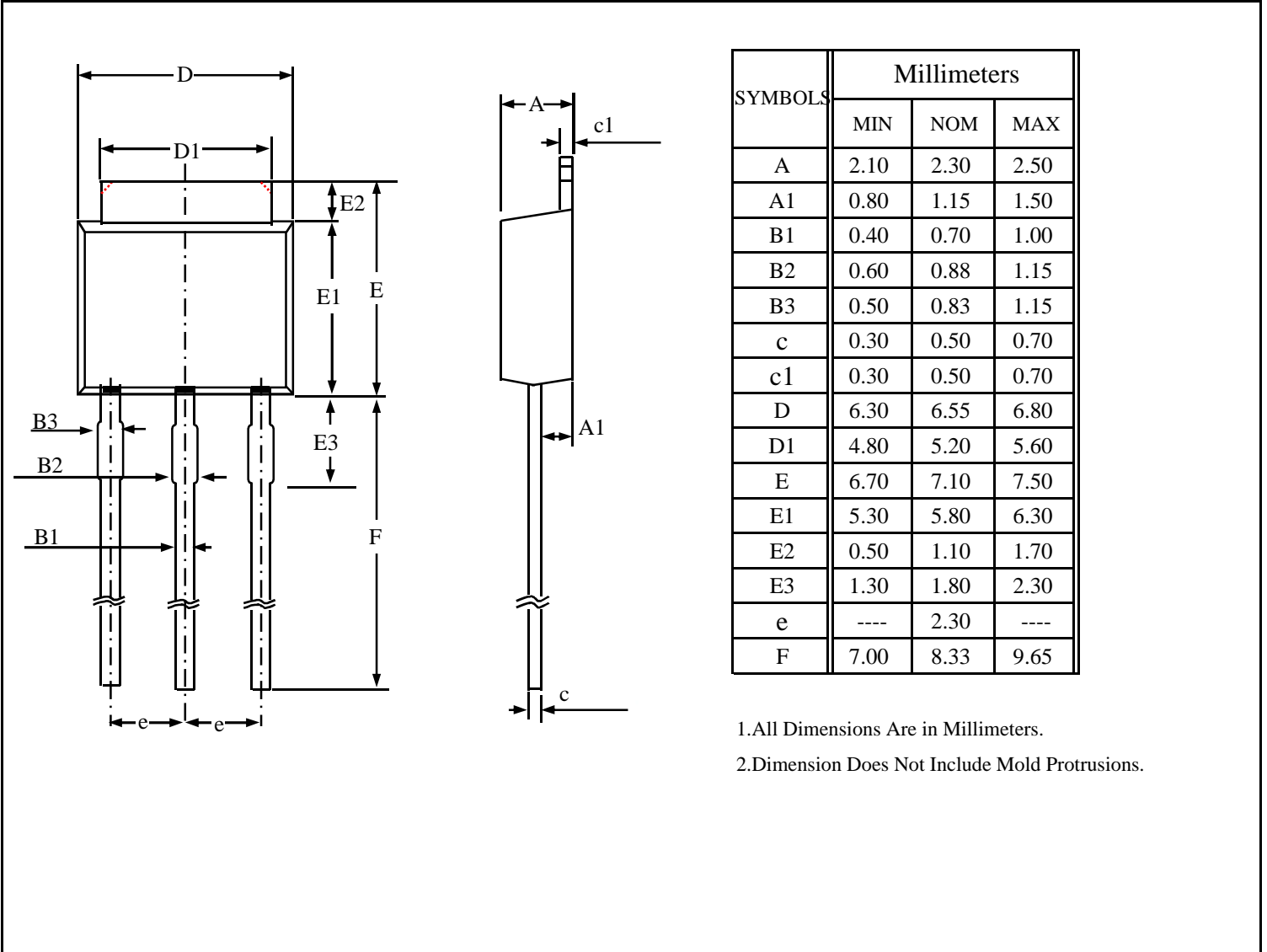

SYMBOLS	Millimeters		
	MIN	NOM	MAX
A	2.10	2.30	2.50
A1	0.80	1.15	1.50
B1	0.40	0.70	1.00
B2	0.60	0.88	1.15
B3	0.50	0.83	1.15
c	0.30	0.50	0.70
c1	0.30	0.50	0.70
D	6.30	6.55	6.80
D1	4.80	5.20	5.60
E	6.70	7.10	7.50
E1	5.30	5.80	6.30
E2	0.50	1.10	1.70
E3	1.30	1.80	2.30
e	----	2.30	----
F	7.00	8.33	9.65

- 1.All Dimensions Are in Millimeters.
- 2.Dimension Does Not Include Mold Protrusions.



**TO-251 FOOTPRINT :**

