

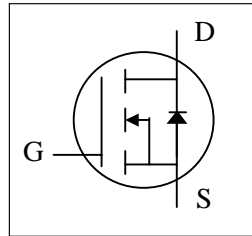

- ▼ 100% R_g & UIS Test
- ▼ Simple Drive Requirement
- ▼ Fast Switching Characteristic
- ▼ RoHS Compliant & Halogen-Free



BV_{DSS}	100V
$R_{DS(ON)}$	7.9m Ω
I_D	75A

Description

AP10N7R9 series are from Advanced Power innovated design and silicon process technology to achieve the lowest possible on-resistance and fast switching performance. It provides the designer with an extreme efficient device for use in a wide range of power applications.

The TO-220 package is widely preferred for all commercial-industrial through hole applications. The low thermal resistance and low package cost contribute to the worldwide popular package.

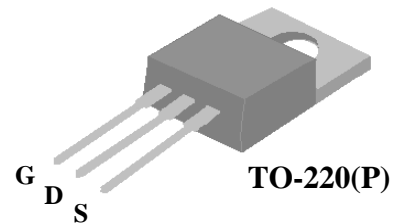

Absolute Maximum Ratings @T_j=25°C (unless otherwise specified)

Symbol	Parameter	Rating	Units
V_{DS}	Drain-Source Voltage	100	V
V_{GS}	Gate-Source Voltage	+20	V
$I_D@T_C=25^\circ C$	Drain Current, V_{GS} @ 10V	75	A
$I_D@T_C=100^\circ C$	Drain Current, V_{GS} @ 10V	48	A
I_{DM}	Pulsed Drain Current ¹	250	A
$P_D@T_C=25^\circ C$	Total Power Dissipation	83.3	W
$P_D@T_A=25^\circ C$	Total Power Dissipation	2	W
E_{AS}	Single Pulse Avalanche Energy ³	45	mJ
T_{STG}	Storage Temperature Range	-55 to 150	°C
T_J	Operating Junction Temperature Range	-55 to 150	°C

Thermal Data

Symbol	Parameter	Value	Units
Rthj-c	Maximum Thermal Resistance, Junction-case	1.5	°C/W
Rthj-a	Maximum Thermal Resistance, Junction-ambient	62	°C/W



AP10N7R9P

Electrical Characteristics @T_j=25°C(unless otherwise specified)

Symbol	Parameter	Test Conditions	Min.	Typ.	Max.	Units
BV _{DSS}	Drain-Source Breakdown Voltage	V _{GS} =0V, I _D =250uA	100	-	-	V
R _{DS(ON)}	Static Drain-Source On-Resistance ²	V _{GS} =10V, I _D =40A	-	-	7.9	mΩ
V _{GS(th)}	Gate Threshold Voltage	V _{DS} =V _{GS} , I _D =250uA	2	-	5	V
g _{fs}	Forward Transconductance	V _{DS} =5V, I _D =40A	-	48	-	S
I _{DSS}	Drain-Source Leakage Current	V _{DS} =80V, V _{GS} =0V	-	-	25	uA
I _{GSS}	Gate-Source Leakage	V _{GS} = ±20V, V _{DS} =0V	-	-	±100	nA
Q _g	Total Gate Charge	I _D =40A	-	67	107.2	nC
Q _{gs}	Gate-Source Charge	V _{DS} =50V	-	20	-	nC
Q _{gd}	Gate-Drain ("Miller") Charge	V _{GS} =10V	-	23	-	nC
t _{d(on)}	Turn-on Delay Time	V _{DS} =50V	-	20	-	ns
t _r	Rise Time	I _D =40A	-	91	-	ns
t _{d(off)}	Turn-off Delay Time	R _G =6Ω	-	43	-	ns
t _f	Fall Time	V _{GS} =10V	-	100	-	ns
C _{iss}	Input Capacitance	V _{GS} =0V	-	3400	5440	pF
C _{oss}	Output Capacitance	V _{DS} =50V	-	800	-	pF
C _{rss}	Reverse Transfer Capacitance	f=1.0MHz	-	10	-	pF
R _g	Gate Resistance	f=1.0MHz	-	1.1	2.2	Ω

Source-Drain Diode

Symbol	Parameter	Test Conditions	Min.	Typ.	Max.	Units
V _{SD}	Forward On Voltage ²	I _S =40A, V _{GS} =0V	-	-	1.3	V
t _{rr}	Reverse Recovery Time	I _S =40A, V _{GS} =0V,	-	56	-	ns
Q _{rr}	Reverse Recovery Charge	dI/dt=100A/μs	-	74	-	nC

Notes:

- 1.Pulse width limited by Max. junction temperature.
- 2.Pulse test
- 3.Starting T_j=25°C , V_{DD}=50V , L=0.1mH , R_G=25Ω , V_{GS}=10V

THIS PRODUCT IS SENSITIVE TO ELECTROSTATIC DISCHARGE, PLEASE HANDLE WITH CAUTION.

USE OF THIS PRODUCT AS A CRITICAL COMPONENT IN LIFE SUPPORT OR OTHER SIMILAR SYSTEMS IS NOT AUTHORIZED.

APEC DOES NOT ASSUME ANY LIABILITY ARISING OUT OF THE APPLICATION OR USE OF ANY PRODUCT OR CIRCUIT DESCRIBED HEREIN; NEITHER DOES IT CONVEY ANY LICENSE UNDER ITS PATENT RIGHTS, NOR THE RIGHTS OF OTHERS.

APEC RESERVES THE RIGHT TO MAKE CHANGES WITHOUT FURTHER NOTICE TO ANY PRODUCTS HEREIN TO IMPROVE RELIABILITY, FUNCTION OR DESIGN.

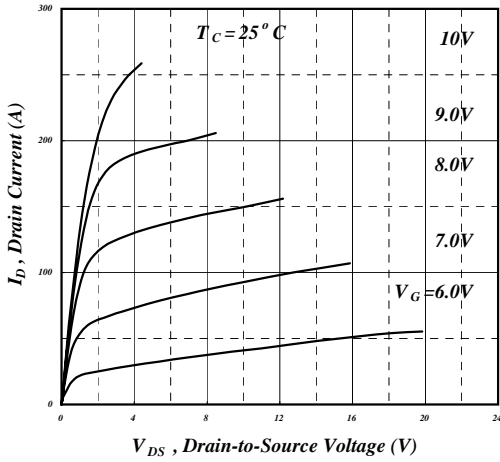

Fig 1. Typical Output Characteristics

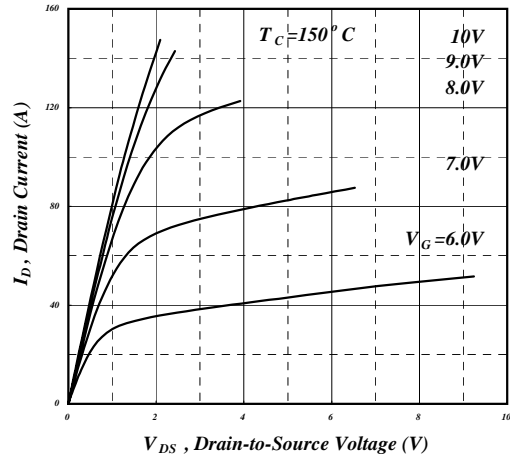

Fig 2. Typical Output Characteristics

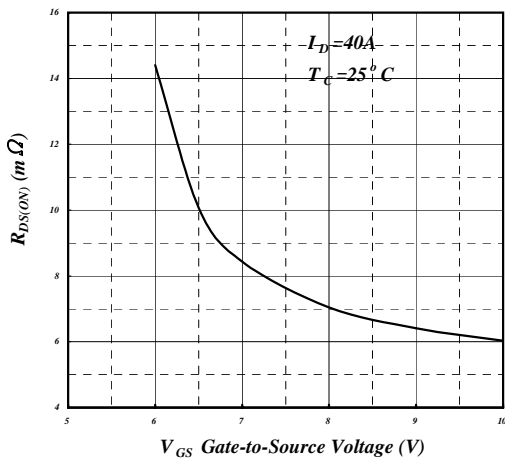

Fig 3. On-Resistance v.s. Gate Voltage

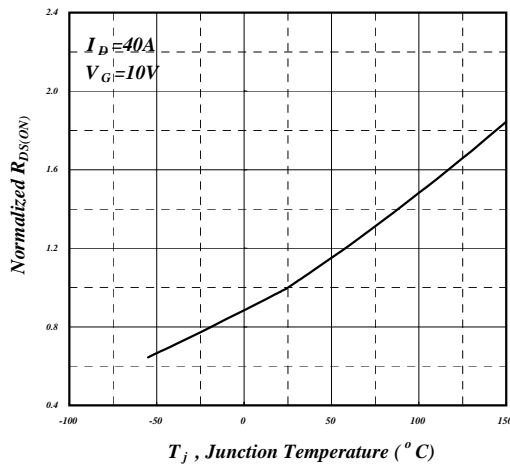

Fig 4. Normalized On-Resistance v.s. Junction Temperature

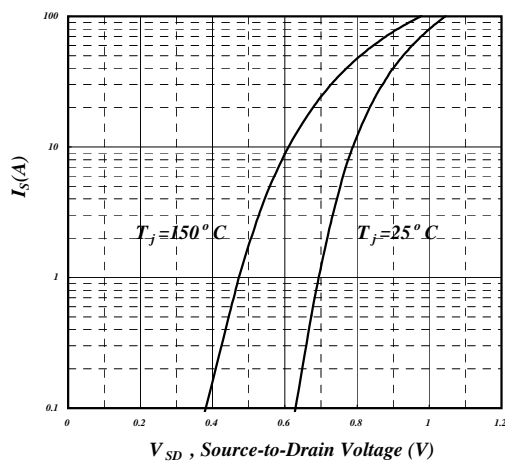

Fig 5. Forward Characteristic of Reverse Diode

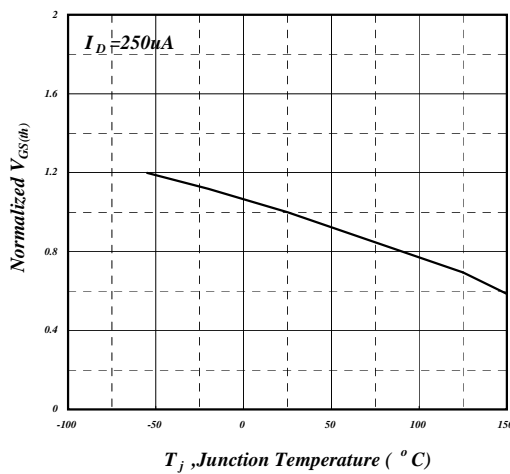

Fig 6. Gate Threshold Voltage v.s. Junction Temperature

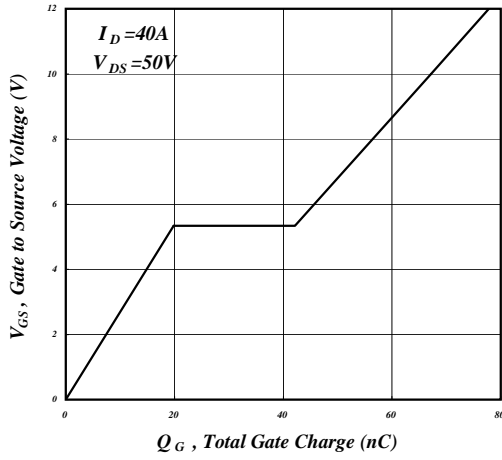

Fig 7. Gate Charge Characteristics

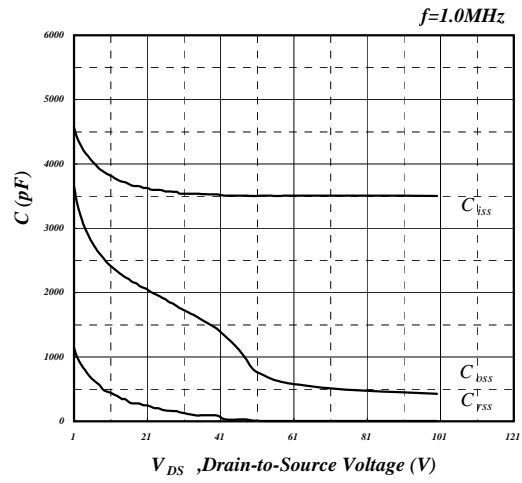

Fig 8. Typical Capacitance Characteristics

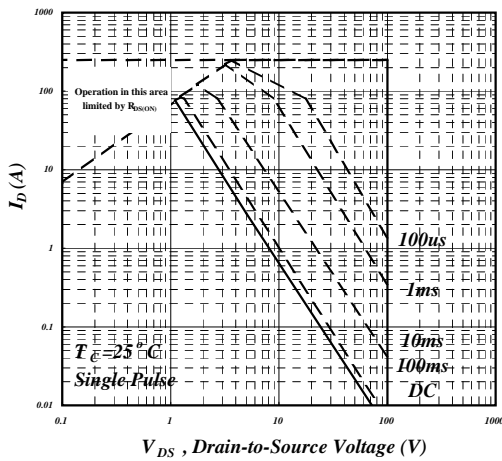

Fig 9. Maximum Safe Operating Area

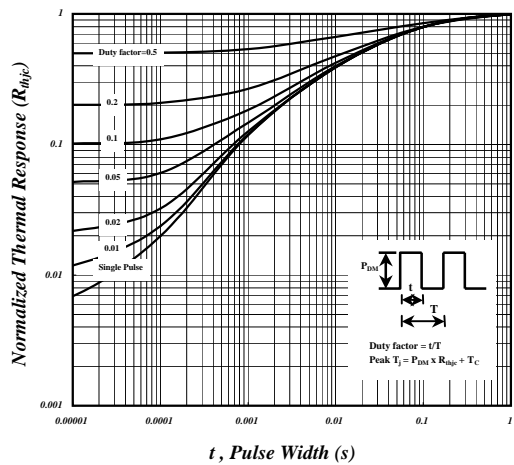

Fig 10. Effective Transient Thermal Impedance

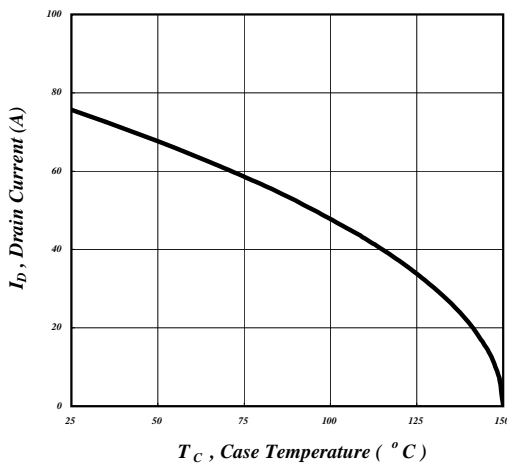

Fig 11. Drain Current v.s. Case Temperature

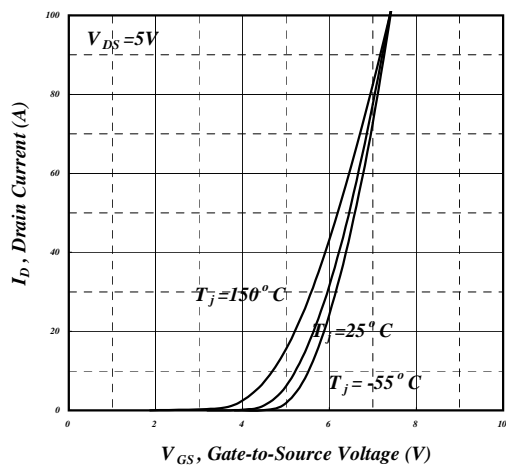

Fig 12. Transfer Characteristics

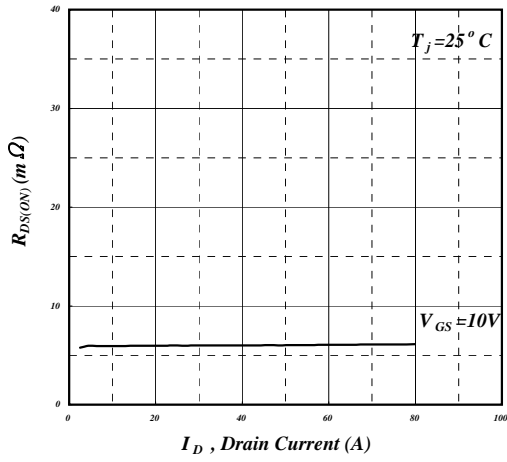

Fig 13. Typ. Drain-Source on State Resistance

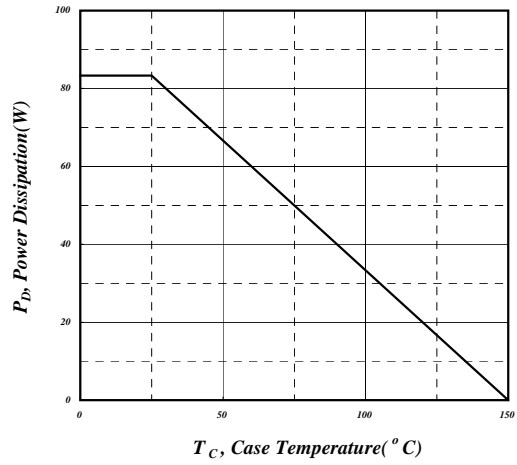

Fig 14. Total Power Dissipation

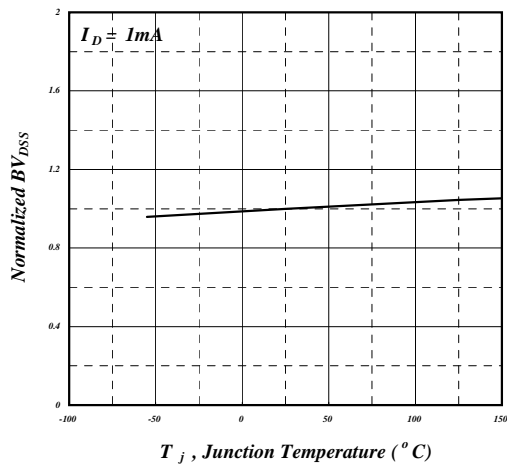
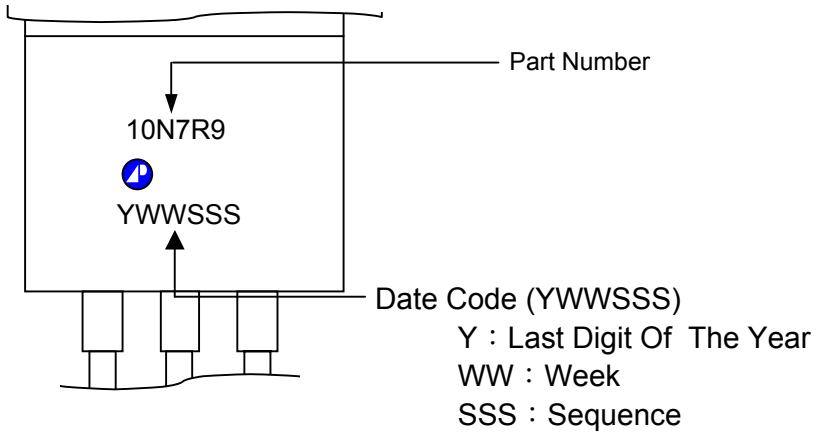

Fig 15. Normalized BV_{DS} v.s. Junction Temperature



AP10N7R9P

MARKING INFORMATION





Package Outline : TO-220

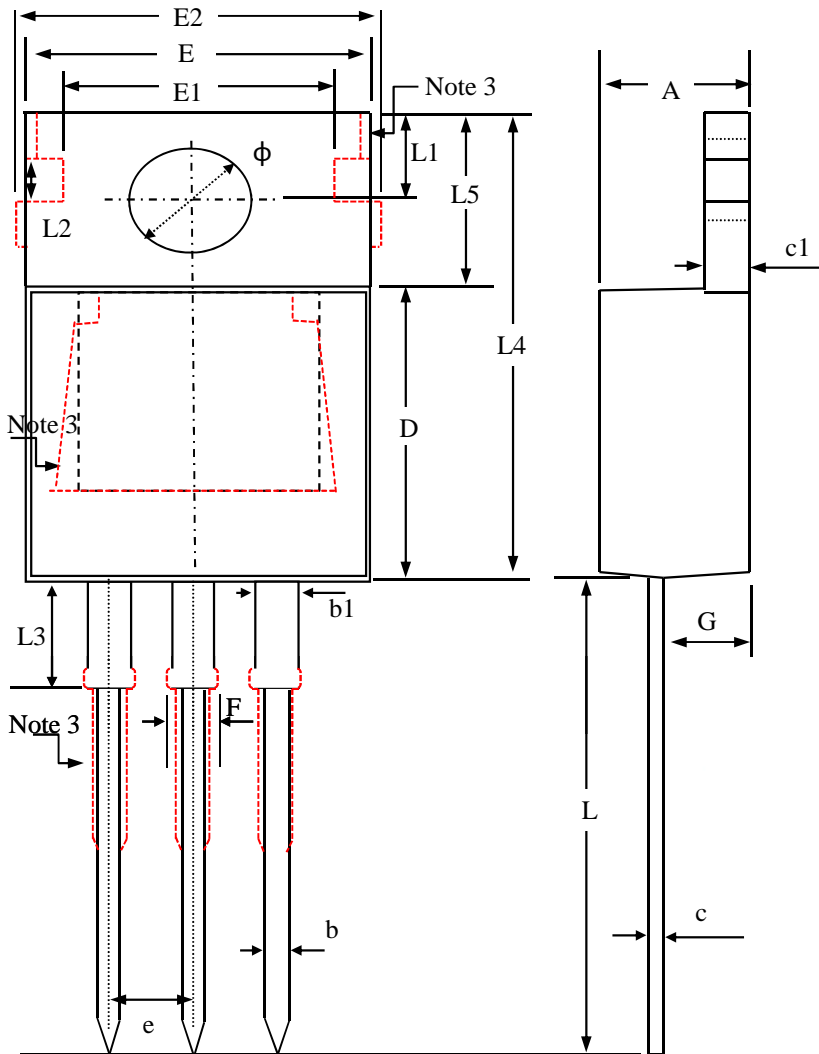

SYMBOLS	Millimeters		
	MIN	NOM	MAX
A	4.20	4.50	4.80
b	0.60	0.80	1.00
b1	1.10	1.38	1.80
c	0.30	0.48	0.65
c1	1.10	1.30	1.50
E	9.70	10.00	10.40
E1	7.40	8.30	9.20
e	2.54 (ref.)		
L	12.70	13.60	14.50
L1	2.50	2.75	3.00
L2	1.00	1.40	1.80
L3	2.60	3.35	4.10
L4	14.30	15.15	16.00
L5	6.00	6.40	6.80
phi	3.40	3.70	4.00
D	8.30	8.85	9.40
F	1.20	1.41	1.85
G	2.20	2.60	3.00
E2	—	—	11.50

Note:

1. All Dimensions Are in Millimeters.
2. Dimension Does Not Include Mold Protrusions.
3. Thermal PAD and Pin contour is for reference, it may has little difference by option.



TO-220 FOOTPRINT :

