

- ▼ 100% R<sub>g</sub> & UIS Test
- ▼ Simple Drive Requirement
- ▼ Fast Switching Characteristic
- ▼ RoHS Compliant & Halogen-Free

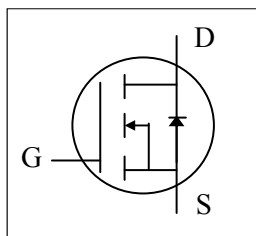

BV <sub>DSS</sub>	100V
R <sub>DS(ON)</sub>	8.2mΩ
I <sub>D</sub>	66A

## Description

AP10NA8R2L series are from Advanced Power innovated design and silicon process technology to achieve the lowest possible on-resistance and fast switching performance. It provides the designer with an extreme efficient device for use in a wide range of power applications.

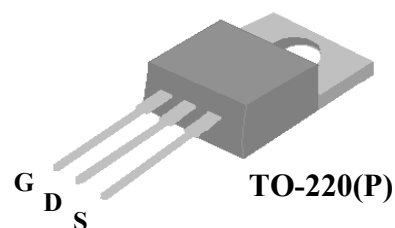

The TO-220 package is widely preferred for all commercial-industrial through hole applications. The low thermal resistance and low package cost contribute to the worldwide popular package.

## Absolute Maximum Ratings@T<sub>j</sub>=25°C(unless otherwise specified)

Symbol	Parameter	Rating	Units
V <sub>DS</sub>	Drain-Source Voltage	100	V
V <sub>GS</sub>	Gate-Source Voltage	+20	V
I <sub>D</sub> @T <sub>C</sub> =25°C	Drain Current, V <sub>GS</sub> @ 10V	66	A
I <sub>D</sub> @T <sub>C</sub> =100°C	Drain Current, V <sub>GS</sub> @ 10V	42	A
I <sub>DM</sub>	Pulsed Drain Current <sup>1</sup>	240	A
P <sub>D</sub> @T <sub>C</sub> =25°C	Total Power Dissipation	69	W
P <sub>D</sub> @T <sub>A</sub> =25°C	Total Power Dissipation	2	W
E <sub>AS</sub>	Single Pulse Avalanche Energy <sup>3</sup>	125	mJ
T <sub>STG</sub>	Storage Temperature Range	-55 to 150	°C
T <sub>J</sub>	Operating Junction Temperature Range	-55 to 150	°C

## Thermal Data

Symbol	Parameter	Value	Units
R <sub>thj-c</sub>	Maximum Thermal Resistance, Junction-case	1.8	°C/W
R <sub>thj-a</sub>	Maximum Thermal Resistance, Junction-ambient	62	°C/W



# AP10NA8R2LP

## Electrical Characteristics@T<sub>j</sub>=25°C(unless otherwise specified)

Symbol	Parameter	Test Conditions	Min.	Typ.	Max.	Units
BV <sub>DSS</sub>	Drain-Source Breakdown Voltage	V <sub>GS</sub> =0V, I <sub>D</sub> =250uA	100	-	-	V
R <sub>DS(ON)</sub>	Static Drain-Source On-Resistance <sup>2</sup>	V <sub>GS</sub> =10V, I <sub>D</sub> =30A	-	-	8.2	mΩ
		V <sub>GS</sub> =4.5V, I <sub>D</sub> =20A	-	-	13.2	mΩ
V <sub>GS(th)</sub>	Gate Threshold Voltage	V <sub>DS</sub> =V <sub>GS</sub> , I <sub>D</sub> =250uA	1.3	-	2.5	V
g <sub>fs</sub>	Forward Transconductance	V <sub>DS</sub> =5V, I <sub>D</sub> =30A	-	58	-	S
I <sub>DSS</sub>	Drain-Source Leakage Current	V <sub>DS</sub> =80V, V <sub>GS</sub> =0V	-	-	25	uA
I <sub>GSS</sub>	Gate-Source Leakage	V <sub>GS</sub> = ±20V, V <sub>DS</sub> =0V	-	-	±0.1	uA
Q <sub>g</sub>	Total Gate Charge	I <sub>D</sub> =30A	-	43	68.8	nC
Q <sub>gs</sub>	Gate-Source Charge	V <sub>DS</sub> =50V	-	6	-	nC
Q <sub>gd</sub>	Gate-Drain ("Miller") Charge	V <sub>GS</sub> =10V	-	17	-	nC
t <sub>d(on)</sub>	Turn-on Delay Time	V <sub>DS</sub> =50V	-	9	-	ns
t <sub>r</sub>	Rise Time	I <sub>D</sub> =30A	-	48	-	ns
t <sub>d(off)</sub>	Turn-off Delay Time	R <sub>G</sub> =7.5Ω	-	44	-	ns
t <sub>f</sub>	Fall Time	V <sub>GS</sub> =10V	-	125	-	ns
C <sub>iss</sub>	Input Capacitance	V <sub>GS</sub> =0V	-	1700	2720	pF
C <sub>oss</sub>	Output Capacitance	V <sub>DS</sub> =80V	-	300	-	pF
C <sub>rss</sub>	Reverse Transfer Capacitance	f=1.0MHz	-	25	-	pF
R <sub>g</sub>	Gate Resistance	f=1.0MHz	-	0.7	1.4	Ω

## Source-Drain Diode

Symbol	Parameter	Test Conditions	Min.	Typ.	Max.	Units
V <sub>SD</sub>	Forward On Voltage <sup>2</sup>	I <sub>S</sub> =30A, V <sub>GS</sub> =0V	-	-	1.3	V
t <sub>rr</sub>	Reverse Recovery Time	I <sub>S</sub> =30A, V <sub>GS</sub> =0V,	-	45	-	ns
Q <sub>rr</sub>	Reverse Recovery Charge	dI/dt=100A/μs	-	45	-	nC

### Notes:

- 1.Pulse width limited by Max. junction temperature.
- 2.Pulse test
- 3.Starting T<sub>j</sub>=25°C , V<sub>DD</sub>=50V , L=0.1mH , R<sub>G</sub>=25Ω , V<sub>GS</sub>=10V

THIS PRODUCT IS SENSITIVE TO ELECTROSTATIC DISCHARGE, PLEASE HANDLE WITH CAUTION.

USE OF THIS PRODUCT AS A CRITICAL COMPONENT IN LIFE SUPPORT, AUTOMOTIVE OR OTHER SIMILAR SYSTEMS IS NOT AUTHORIZED.

APEC DOES NOT ASSUME ANY LIABILITY ARISING OUT OF THE APPLICATION OR USE OF ANY PRODUCT OR CIRCUIT DESCRIBED HEREIN; NEITHER DOES IT CONVEY ANY LICENSE UNDER ITS PATENT RIGHTS, NOR THE RIGHTS OF OTHERS.

APEC RESERVES THE RIGHT TO MAKE CHANGES WITHOUT FURTHER NOTICE TO ANY PRODUCTS HEREIN TO IMPROVE RELIABILITY, FUNCTION OR DESIGN.

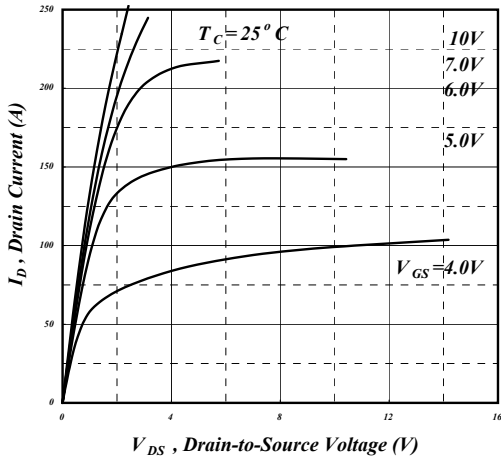

Fig 1. Typical Output Characteristics

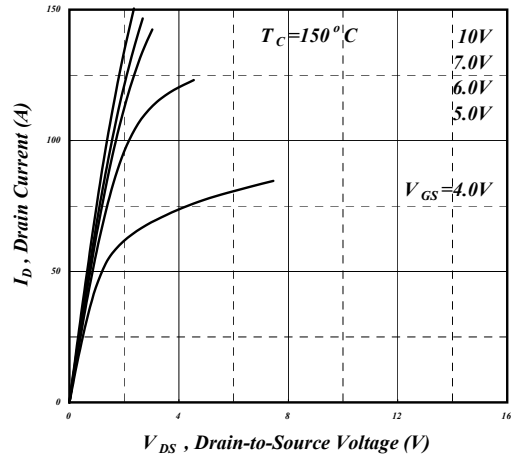

Fig 2. Typical Output Characteristics

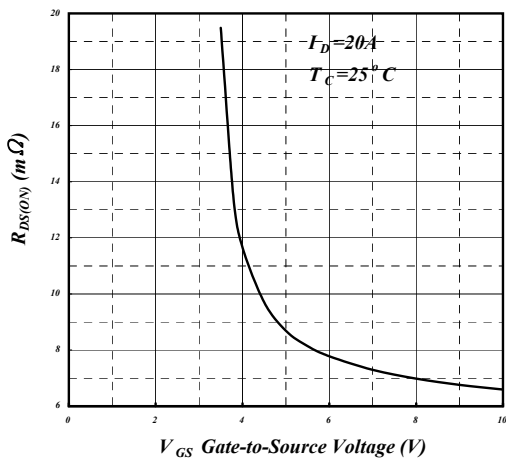

Fig 3. On-Resistance v.s. Gate Voltage

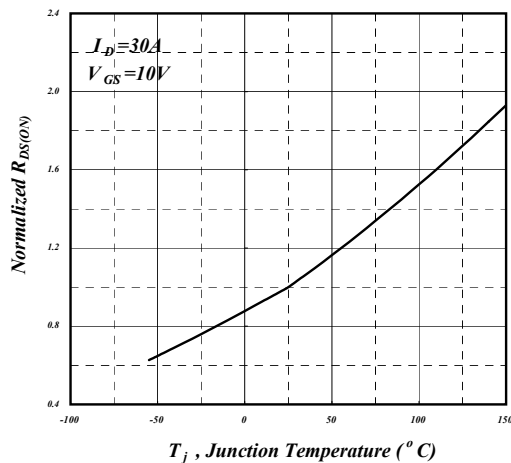

Fig 4. Normalized On-Resistance v.s. Junction Temperature

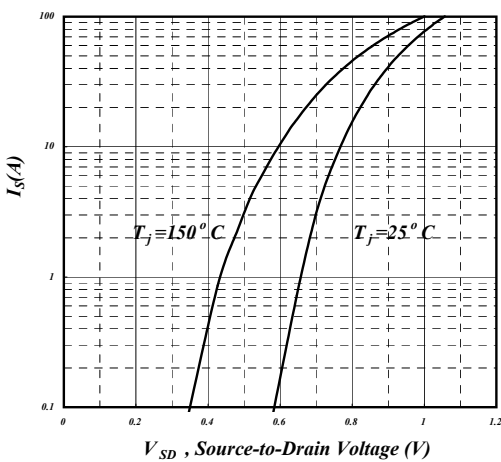

Fig 5. Forward Characteristic of Reverse Diode

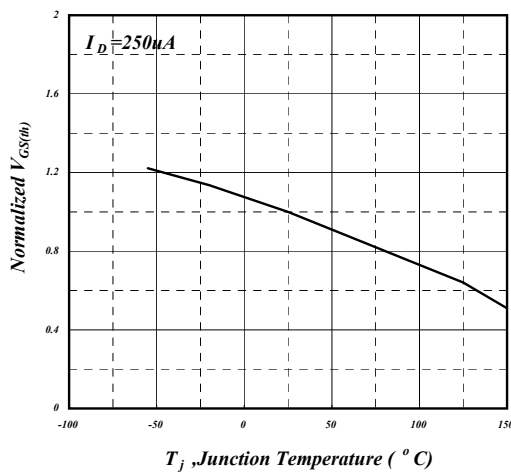

Fig 6. Gate Threshold Voltage v.s. Junction Temperature



# AP10NA8R2LP

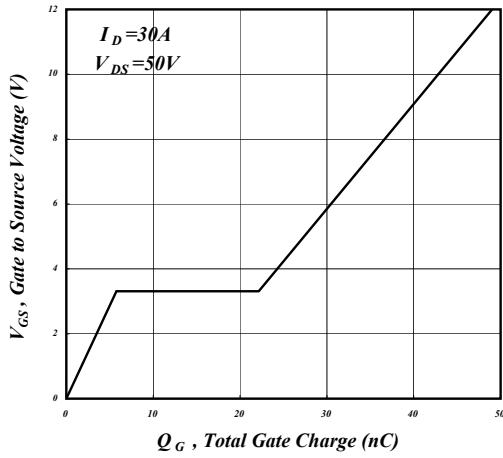

Fig 7. Gate Charge Characteristics

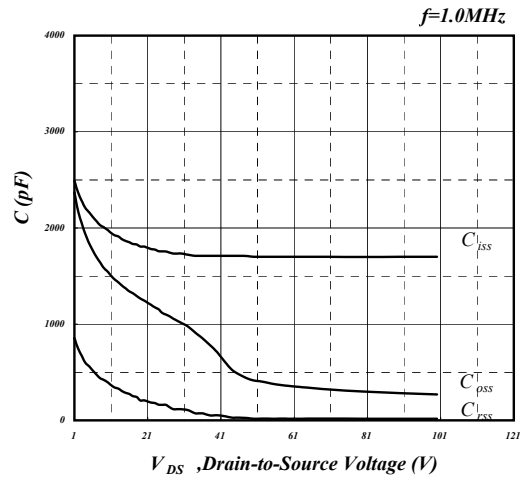

Fig 8. Typical Capacitance Characteristics

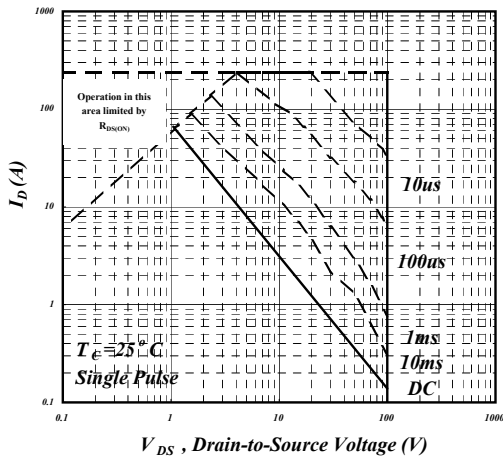

Fig 9. Maximum Safe Operating Area

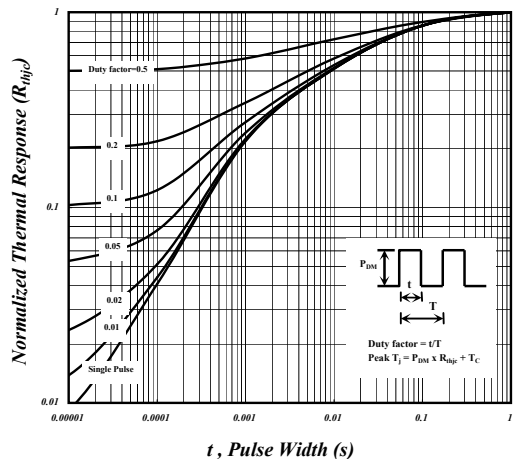

Fig 10. Effective Transient Thermal Impedance

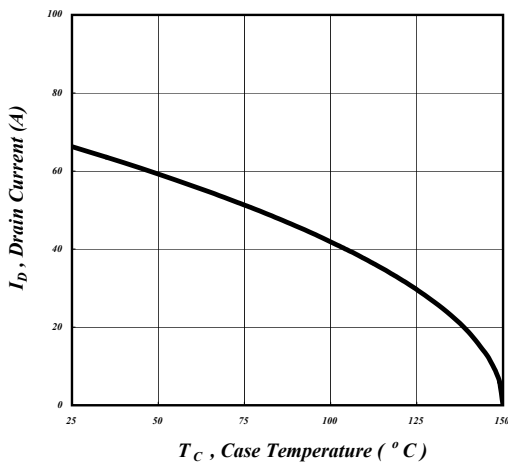

Fig 11. Drain Current v.s. Case Temperature

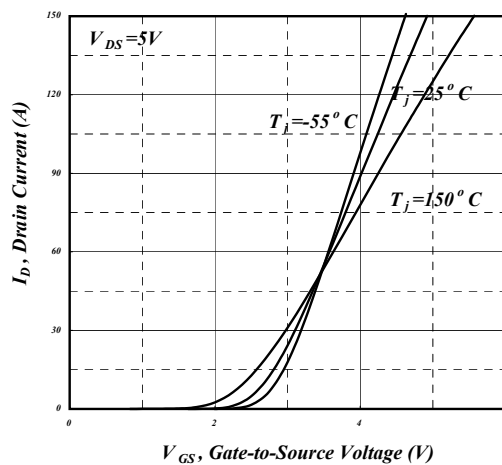

Fig 12. Transfer Characteristics

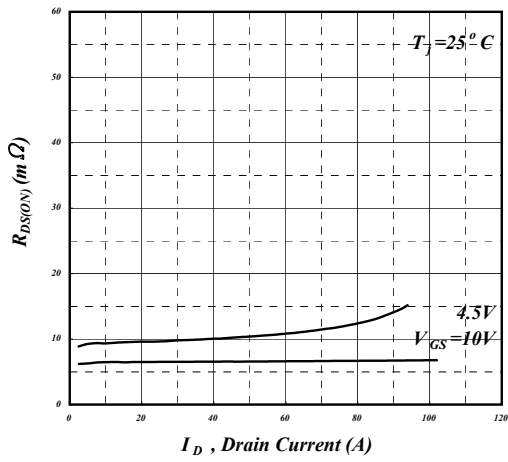

Fig 13. Typ. Drain-Source on State Resistance

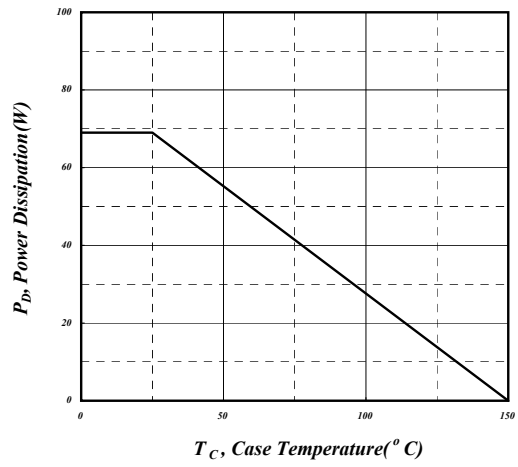

Fig 14. Total Power Dissipation

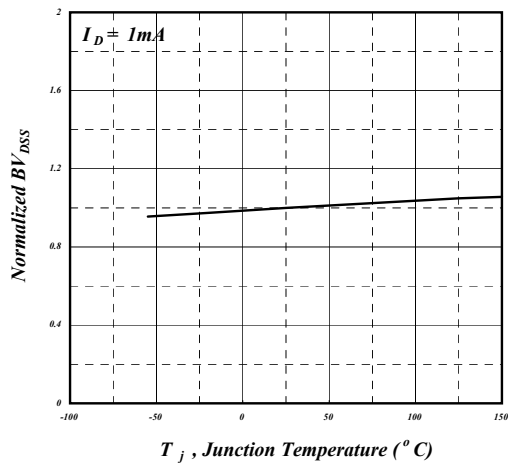

Fig 15. Normalized  $BV_{DSS}$  v.s. Junction Temperature



# AP10NA8R2LP

---

## MARKING INFORMATION

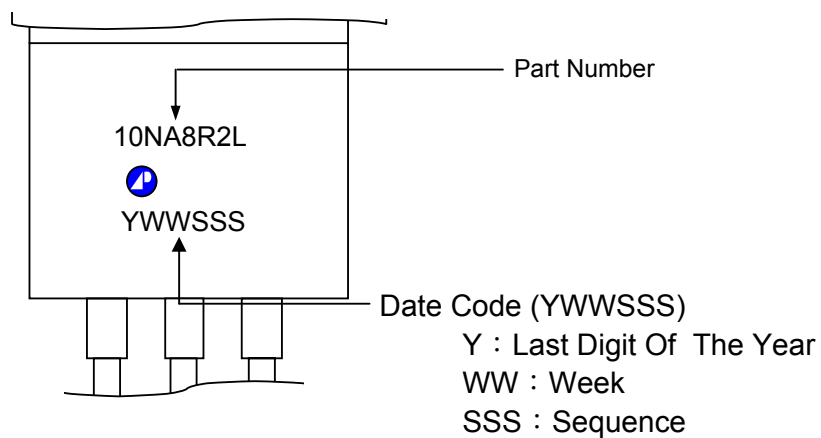



## Package Outline : TO-220

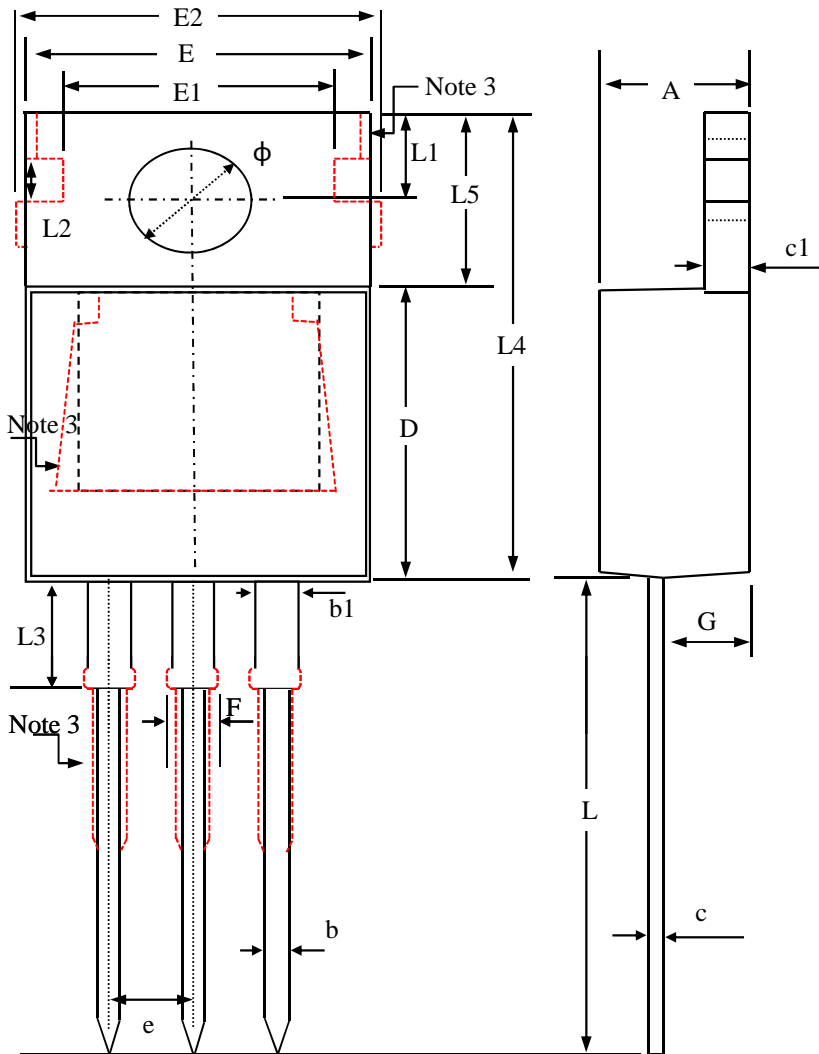

SYMBOLS	Millimeters		
	MIN	NOM	MAX
A	4.20	4.50	4.80
b	0.60	0.80	1.00
b1	1.10	1.38	1.80
c	0.30	0.48	0.65
c1	1.10	1.30	1.50
E	9.70	10.00	10.40
E1	7.40	8.30	9.20
e	2.54 (ref.)		
L	12.70	13.60	14.50
L1	2.50	2.75	3.00
L2	1.00	1.40	1.80
L3	2.60	3.35	4.10
L4	14.30	15.15	16.00
L5	6.00	6.40	6.80
$\phi$	3.40	3.70	4.00
D	8.30	8.85	9.40
F	1.20	1.41	1.85
G	2.20	2.60	3.00
E2	—	—	11.50

Note:

1. All Dimensions Are in Millimeters.
2. Dimension Does Not Include Mold Protrusions.
3. Thermal PAD and Pin contour is for reference, it may has little difference by option.



**TO-220 FOOTPRINT :**

