

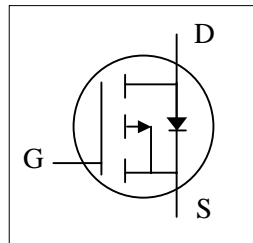

- ▼ Simple Drive Requirement
- ▼ Small Size & Lower Profile
- ▼ RoHS Compliant & Halogen-Free



$BV_{DSS}$	-20V
$R_{DS(ON)}$	18m $\Omega$
$I_D$	-11.3A

**Description**

Advanced Power MOSFETs from APEC provide the designer with the best combination of fast switching, ruggedized device design, low on-resistance and cost-effectiveness.

The PMPAK<sup>®</sup> 3 x 3 package is special for DC-DC converters application and lower 1.0mm profile with backside heat sink.

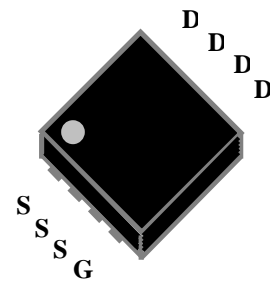

**PMPAK<sup>®</sup> 3x3**

**Absolute Maximum Ratings @T<sub>j</sub>=25°C (unless otherwise specified)**

Symbol	Parameter	Rating	Units
$V_{DS}$	Drain-Source Voltage	-20	V
$V_{GS}$	Gate-Source Voltage	$\pm 8$	V
$I_D @ T_A=25^\circ C$	Drain Current <sup>3</sup> , $V_{GS}$ @ 4.5V	-11.3	A
$I_D @ T_A=70^\circ C$	Drain Current <sup>3</sup> , $V_{GS}$ @ 4.5V	-9	A
$I_{DM}$	Pulsed Drain Current <sup>1</sup>	-40	A
$P_D @ T_A=25^\circ C$	Total Power Dissipation	3.57	W
$T_{STG}$	Storage Temperature Range	-55 to 150	$^\circ C$
$T_J$	Operating Junction Temperature Range	-55 to 150	$^\circ C$

**Thermal Data**

Symbol	Parameter	Value	Unit
Rthj-c	Maximum Thermal Resistance, Junction-case	6	$^\circ C/W$
Rthj-a	Maximum Thermal Resistance, Junction-ambient <sup>3</sup>	35	$^\circ C/W$



# AP2609GYT-HF

## Electrical Characteristics @T<sub>j</sub>=25°C(unless otherwise specified)

Symbol	Parameter	Test Conditions	Min.	Typ.	Max.	Units
BV <sub>DSS</sub>	Drain-Source Breakdown Voltage	V <sub>GS</sub> =0V, I <sub>D</sub> =-250uA	-20	-	-	V
R <sub>DS(ON)</sub>	Static Drain-Source On-Resistance <sup>2</sup>	V <sub>GS</sub> =-4.5V, I <sub>D</sub> =-7A	-	15	18	mΩ
		V <sub>GS</sub> =-2.5V, I <sub>D</sub> =-5A	-	18	24	mΩ
		V <sub>GS</sub> =-1.8V, I <sub>D</sub> =-2A	-	23	35	mΩ
V <sub>GS(th)</sub>	Gate Threshold Voltage	V <sub>DS</sub> =V <sub>GS</sub> , I <sub>D</sub> =-250uA	-0.25	-0.43	-1	V
g <sub>fs</sub>	Forward Transconductance	V <sub>DS</sub> =-5V, I <sub>D</sub> =-7A	-	25	-	S
I <sub>DSS</sub>	Drain-Source Leakage Current	V <sub>DS</sub> =-16V, V <sub>GS</sub> =0V	-	-	-10	uA
I <sub>GSS</sub>	Gate-Source Leakage	V <sub>GS</sub> =±8V, V <sub>DS</sub> =0V	-	-	±100	nA
Q <sub>g</sub>	Total Gate Charge	I <sub>D</sub> =-7A	-	26.5	42	nC
Q <sub>gs</sub>	Gate-Source Charge	V <sub>DS</sub> =-10V	-	2.3	-	nC
Q <sub>gd</sub>	Gate-Drain ("Miller") Charge	V <sub>GS</sub> =-4.5V	-	7	-	nC
t <sub>d(on)</sub>	Turn-on Delay Time	V <sub>DS</sub> =-10V	-	10	-	ns
t <sub>r</sub>	Rise Time	I <sub>D</sub> =-1A	-	17	-	ns
t <sub>d(off)</sub>	Turn-off Delay Time	R <sub>G</sub> =3.3Ω	-	90	-	ns
t <sub>f</sub>	Fall Time	V <sub>GS</sub> =-5V	-	75	-	ns
C <sub>iss</sub>	Input Capacitance	V <sub>GS</sub> =0V	-	2210	3540	pF
C <sub>oss</sub>	Output Capacitance	V <sub>DS</sub> =-10V	-	305	-	pF
C <sub>rss</sub>	Reverse Transfer Capacitance	f=1.0MHz	-	290	-	pF
R <sub>g</sub>	Gate Resistance	f=1.0MHz	-	4.6	9.2	Ω

## Source-Drain Diode

Symbol	Parameter	Test Conditions	Min.	Typ.	Max.	Units
V <sub>SD</sub>	Forward On Voltage <sup>2</sup>	I <sub>S</sub> =-2.9A, V <sub>GS</sub> =0V	-	-	-1.2	V
t <sub>rr</sub>	Reverse Recovery Time	I <sub>S</sub> =-7A, V <sub>GS</sub> =0V,	-	30	-	ns
Q <sub>rr</sub>	Reverse Recovery Charge	di/dt=100A/μs	-	50	-	nC

### Notes:

- 1.Pulse width limited by Max. junction temperature.
- 2.Pulse test
- 3.Surface mounted on 1 in<sup>2</sup> copper pad of FR4 board, t ≤10sec ; 85°C at steady state.

THIS PRODUCT IS SENSITIVE TO ELECTROSTATIC DISCHARGE, PLEASE HANDLE WITH CAUTION.

USE OF THIS PRODUCT AS A CRITICAL COMPONENT IN LIFE SUPPORT OR OTHER SIMILAR SYSTEMS IS NOT AUTHORIZED.

APEC DOES NOT ASSUME ANY LIABILITY ARISING OUT OF THE APPLICATION OR USE OF ANY PRODUCT OR CIRCUIT DESCRIBED HEREIN; NEITHER DOES IT CONVEY ANY LICENSE UNDER ITS PATENT RIGHTS, NOR THE RIGHTS OF OTHERS.

APEC RESERVES THE RIGHT TO MAKE CHANGES WITHOUT FURTHER NOTICE TO ANY PRODUCTS HEREIN TO IMPROVE RELIABILITY, FUNCTION OR DESIGN.

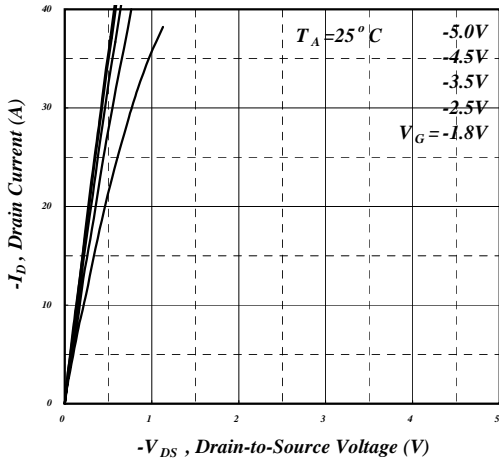

Fig 1. Typical Output Characteristics

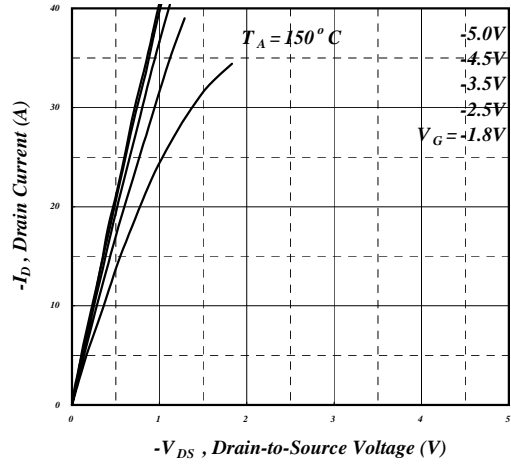

Fig 2. Typical Output Characteristics

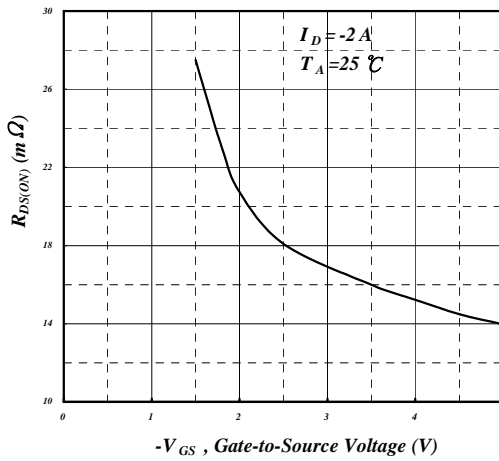

Fig 3. On-Resistance v.s. Gate Voltage

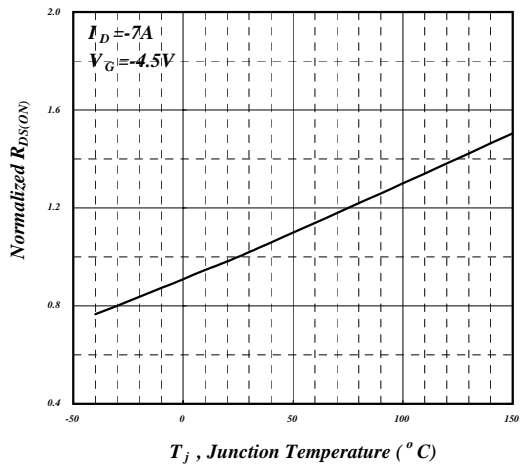

Fig 4. Normalized On-Resistance v.s. Junction Temperature

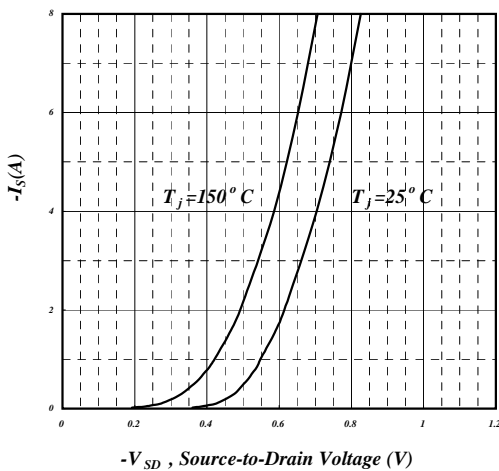

Fig 5. Forward Characteristic of Reverse Diode

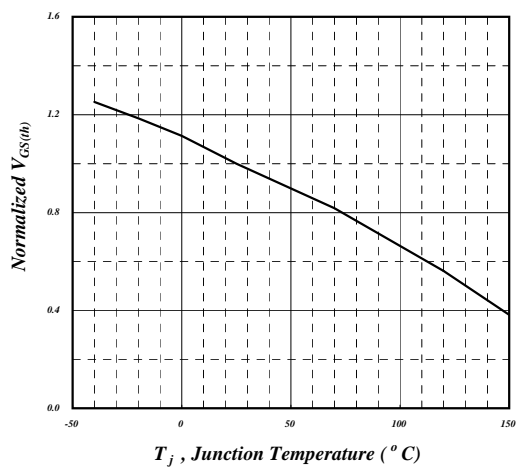

Fig 6. Gate Threshold Voltage v.s. Junction Temperature

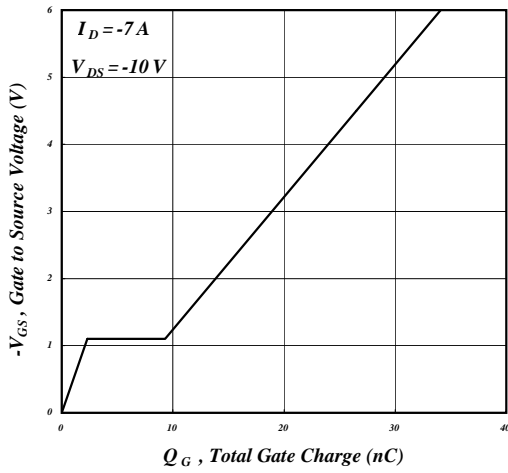

Fig 7. Gate Charge Characteristics

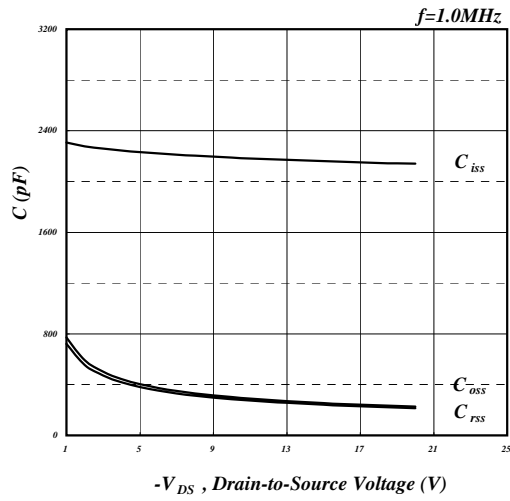

Fig 8. Typical Capacitance Characteristics

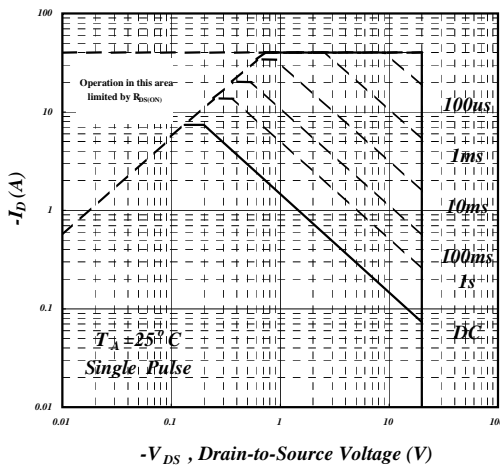

Fig 9. Maximum Safe Operating Area

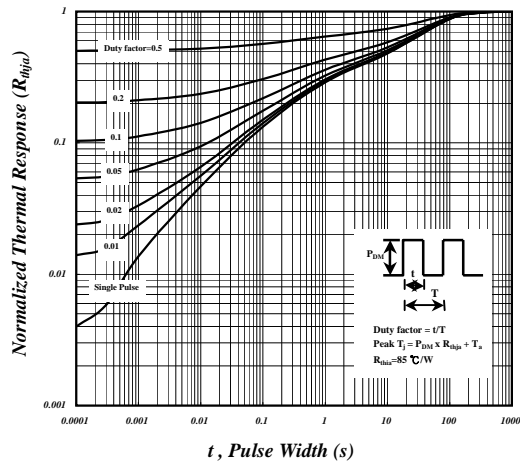

Fig 10. Effective Transient Thermal Impedance

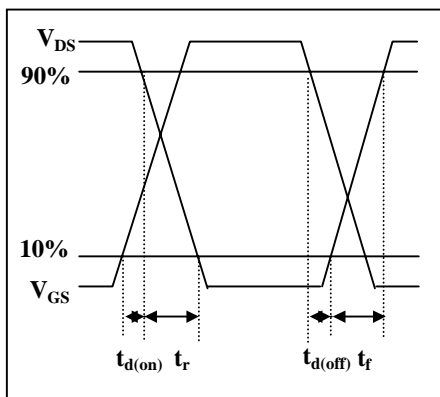

Fig 11. Switching Time Waveform

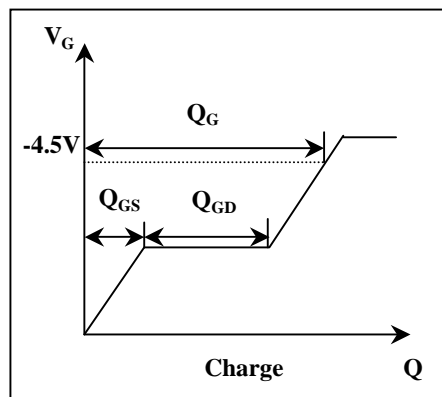
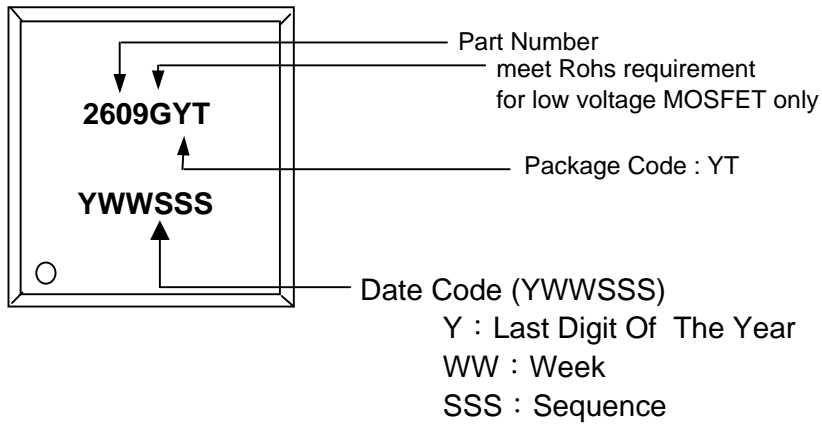

Fig 12. Gate Charge Waveform



# MARKING INFORMATION





## Package Outline : PMPAK 3x3

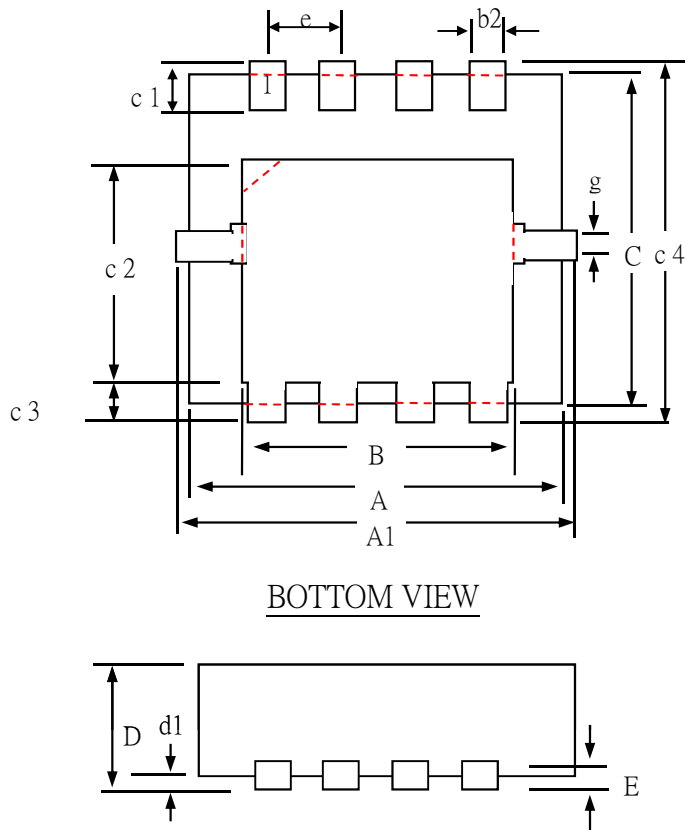

SYMBOLS	Millimeters		
	MIN	NOM	MAX
A	2.90	3.10	3.40
B	2.20	2.45	2.80
e	0.60	0.65	0.70
b2	0.20	0.30	0.40
C	2.90	3.10	3.40
c1	0.10	0.30	0.50
c2	1.20	1.70	2.20
c3	0.10	0.38	0.65
D	0.65	0.80	1.05
d1	0.00	0.10	0.20
E	0.10	0.18	0.25
A1	2.900	3.30	3.600
c4	2.900	3.30	3.600
g	0.20 (ref)		

1. All Dimension Are In Millimeters.
2. Dimension Does Not Include Mold Protrusions.
3. Thermal PAD and Pin contour is for reference, it may has little difference by option.



PMPAK3X3 FOOTPRINT :

