

- ▼ Simple Drive Requirement
- ▼ Good Thermal Performance
- ▼ Fast Switching Performance
- ▼ RoHS Compliant & Halogen-Free

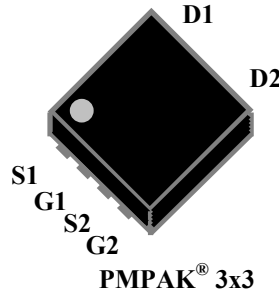

N-CH	BV_{DSS}	30V
	$R_{DS(ON)}$	35m Ω
P-CH	BV_{DSS}	-30V
	$R_{DS(ON)}$	48m Ω

Description

AP3702 series are from Advanced Power innovated design and silicon process technology to achieve the lowest possible on-resistance and fast switching performance. It provides the designer with an extreme efficient device for use in a wide range of power applications.

The PMPAK[®] 3x3 package is special for voltage conversion application using standard infrared reflow technique with the backside heat sink to achieve the good thermal performance.

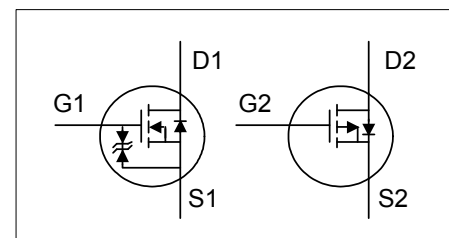

Absolute Maximum Ratings@T_j=25°C(unless otherwise specified)

Symbol	Parameter	Rating		Units
		N-channel	P-channel	
V_{DS}	Drain-Source Voltage	30	-30	V
V_{GS}	Gate-Source Voltage	± 20	± 20	V
$I_D@T_C=25^\circ C$	Drain Current, V_{GS} @ 10V	14.7	-13.4	A
$I_D@T_C=100^\circ C$	Drain Current, V_{GS} @ 10V	9.3	-8.5	A
$I_D@T_A=25^\circ C$	Drain Current, V_{GS} @ 10V ³	6.6	-6	A
$I_D@T_A=70^\circ C$	Drain Current, V_{GS} @ 10V ³	5.3	-4.8	A
I_{DM}	Pulsed Drain Current ¹	24	-20	A
$P_D@T_A=25^\circ C$	Total Power Dissipation	2.5		W
T_{STG}	Storage Temperature Range	-55 to 150		°C
T_J	Operating Junction Temperature Range	-55 to 150		°C

Thermal Data

Symbol	Parameter	Value	Unit
Rthj-c	Maximum Thermal Resistance, Junction-case	10	°C/W
Rthj-a	Maximum Thermal Resistance, Junction-ambient ³	50	°C/W



AP3702YT

N-CH Electrical Characteristics @ $T_j=25^\circ\text{C}$ (unless otherwise specified)

Symbol	Parameter	Test Conditions	Min.	Typ.	Max.	Units
BV_{DSS}	Drain-Source Breakdown Voltage	$V_{GS}=0V, I_D=250\mu A$	30	-	-	V
$R_{DS(ON)}$	Static Drain-Source On-Resistance ²	$V_{GS}=10V, I_D=6A$	-	-	35	m Ω
		$V_{GS}=4.5V, I_D=4A$	-	-	56	m Ω
$V_{GS(th)}$	Gate Threshold Voltage	$V_{DS}=V_{GS}, I_D=250\mu A$	1.4	-	2.5	V
g_{fs}	Forward Transconductance	$V_{DS}=5V, I_D=6A$	-	15	-	S
I_{DSS}	Drain-Source Leakage Current	$V_{DS}=24V, V_{GS}=0V$	-	-	10	μA
I_{GSS}	Gate-Source Leakage	$V_{GS}=\pm 20V, V_{DS}=0V$	-	-	± 30	μA
Q_g	Total Gate Charge	$I_D=4A$	-	4	6.4	nC
Q_{gs}	Gate-Source Charge	$V_{DS}=15V$	-	1.5	-	nC
Q_{gd}	Gate-Drain ("Miller") Charge	$V_{GS}=4.5V$	-	1.5	-	nC
$t_{d(on)}$	Turn-on Delay Time	$V_{DS}=15V$	-	6	-	ns
t_r	Rise Time	$I_D=1A$	-	9	-	ns
$t_{d(off)}$	Turn-off Delay Time	$R_G=3.3\Omega$	-	12	-	ns
t_f	Fall Time	$V_{GS}=10V$	-	3	-	ns
C_{iss}	Input Capacitance	$V_{GS}=0V$	-	300	480	pF
C_{oss}	Output Capacitance	$V_{DS}=15V$	-	55	-	pF
C_{rss}	Reverse Transfer Capacitance	$f=1.0\text{MHz}$	-	45	-	pF

Source-Drain Diode

Symbol	Parameter	Test Conditions	Min.	Typ.	Max.	Units
V_{SD}	Forward On Voltage ²	$I_S=2A, V_{GS}=0V$	-	-	1.2	V
t_{rr}	Reverse Recovery Time	$I_S=6A, V_{GS}=0V$	-	8	-	ns
Q_{rr}	Reverse Recovery Charge	$dI/dt=100A/\mu s$	-	2	-	nC

**P-CH Electrical Characteristics@T_j=25°C(unless otherwise specified)**

Symbol	Parameter	Test Conditions	Min.	Typ.	Max.	Unit
BV _{DSS}	Drain-Source Breakdown Voltage	V _{GS} =0V, I _D =-250uA	-30	-	-	V
R _{DS(ON)}	Static Drain-Source On-Resistance ²	V _{GS} =-10V, I _D =-6A	-	-	48	mΩ
		V _{GS} =-4.5V, I _D =-3A	-	-	85	mΩ
V _{GS(th)}	Gate Threshold Voltage	V _{DS} =V _{GS} , I _D =-250uA	-1	-	-2.5	V
g _{fs}	Forward Transconductance	V _{DS} =-5V, I _D =-6A	-	9	-	S
I _{DSS}	Drain-Source Leakage Current	V _{DS} =-24V, V _{GS} =0V	-	-	-10	uA
I _{GSS}	Gate-Source Leakage	V _{GS} =+20V, V _{DS} =0V	-	-	±1	uA
Q _g	Total Gate Charge	I _D =-3A	-	6	9.6	nC
Q _{gs}	Gate-Source Charge	V _{DS} =-15V	-	2.2	-	nC
Q _{gd}	Gate-Drain ("Miller") Charge	V _{GS} =-4.5V	-	2	-	nC
t _{d(on)}	Turn-on Delay Time	V _{DS} =-15V	-	10	-	ns
t _r	Rise Time	I _D =-1A	-	6.5	-	ns
t _{d(off)}	Turn-off Delay Time	R _G =6Ω	-	32	-	ns
t _f	Fall Time	V _{GS} =-10V	-	17	-	ns
C _{iss}	Input Capacitance	V _{GS} =0V	-	610	976	pF
C _{oss}	Output Capacitance	V _{DS} =-15V	-	100	-	pF
C _{rss}	Reverse Transfer Capacitance	f=1.0MHz	-	70	-	pF

Source-Drain Diode

Symbol	Parameter	Test Conditions	Min.	Typ.	Max.	Unit
V _{SD}	Forward On Voltage ²	I _S =-2A, V _{GS} =0V	-	-	-1.2	V
t _{rr}	Reverse Recovery Time	I _S =-6A, V _{GS} =0V,	-	9	-	ns
Q _{rr}	Reverse Recovery Charge	dI/dt=100A/μs	-	4	-	nC

Notes:

- 1.Pulse width limited by Max. junction temperature.
- 2.Pulse test
- 3.Surface mounted on 1 in² copper pad of FR4 board, t ≤10sec, 90°C/W at steady state.

THIS PRODUCT IS SENSITIVE TO ELECTROSTATIC DISCHARGE, PLEASE HANDLE WITH CAUTION.

USE OF THIS PRODUCT AS A CRITICAL COMPONENT IN LIFE SUPPORT, AUTOMOTIVE OR OTHER SIMILAR SYSTEMS IS NOT AUTHORIZED. APEC DOES NOT ASSUME ANY LIABILITY ARISING OUT OF THE APPLICATION OR USE OF ANY PRODUCT OR CIRCUIT DESCRIBED HEREIN; NEITHER DOES IT CONVEY ANY LICENSE UNDER ITS PATENT RIGHTS, NOR THE RIGHTS OF OTHERS.

APEC RESERVES THE RIGHT TO MAKE CHANGES WITHOUT FURTHER NOTICE TO ANY PRODUCTS HEREIN TO IMPROVE RELIABILITY, FUNCTION OR DESIGN.



AP3702YT

N-Channel

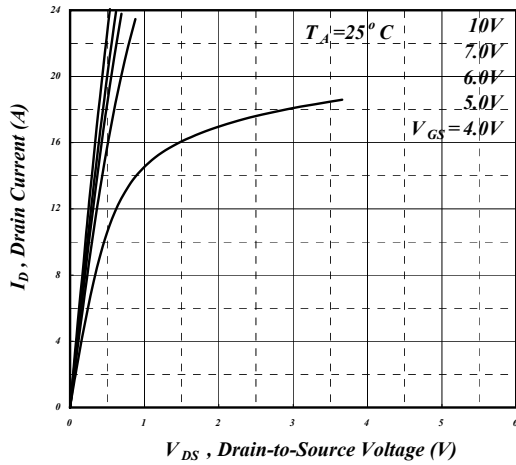

Fig 1. Typical Output Characteristics

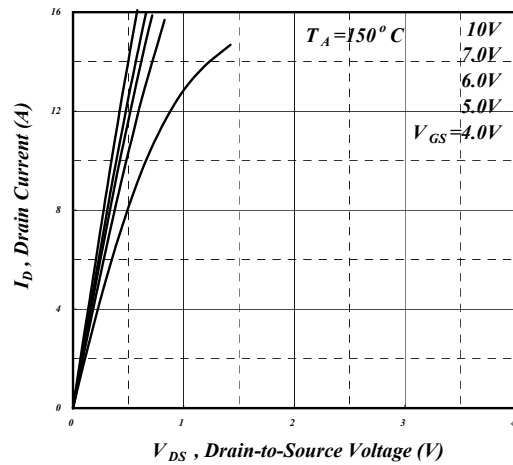

Fig 2. Typical Output Characteristics

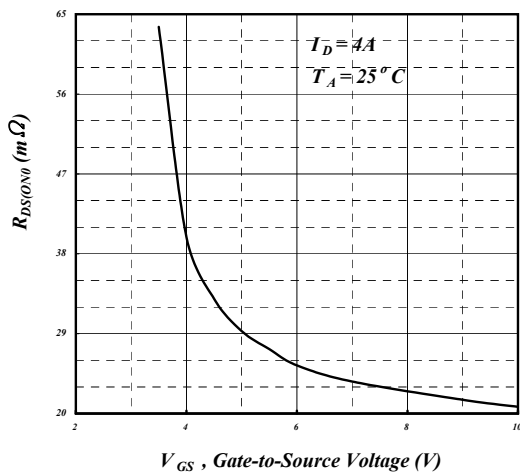

Fig 3. On-Resistance v.s. Gate Voltage

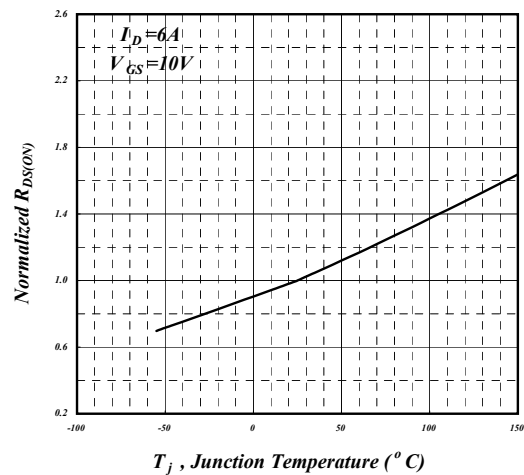

Fig 4. Normalized On-Resistance v.s. Junction Temperature

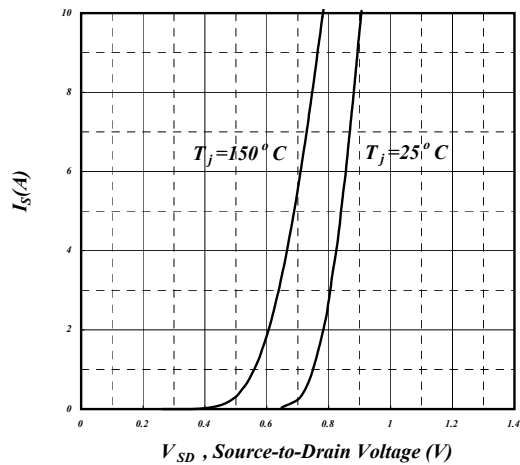

Fig 5. Forward Characteristic of Reverse Diode

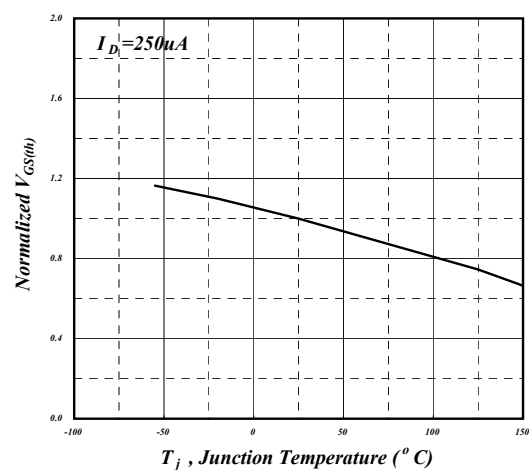

Fig 6. Gate Threshold Voltage v.s. Junction Temperature



N-Channel

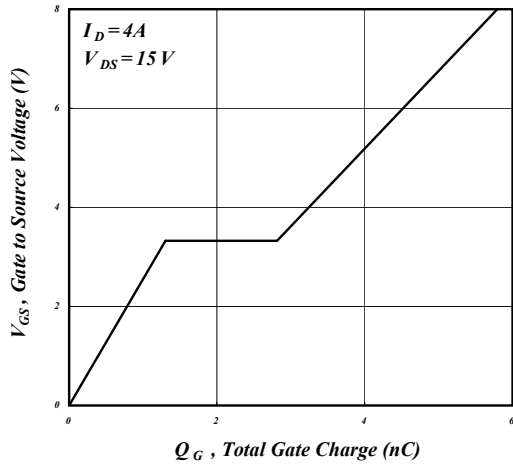

Fig 7. Gate Charge Characteristics

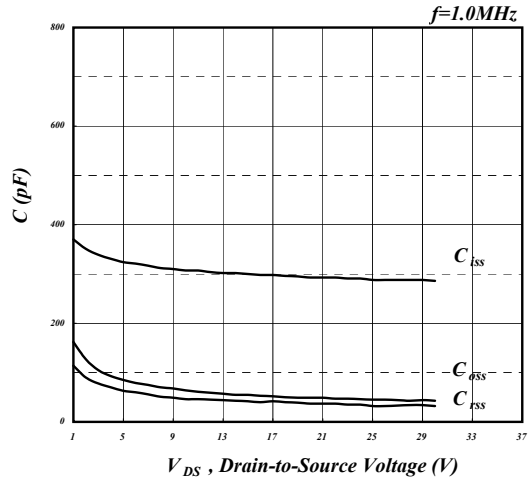

Fig 8. Typical Capacitance Characteristics

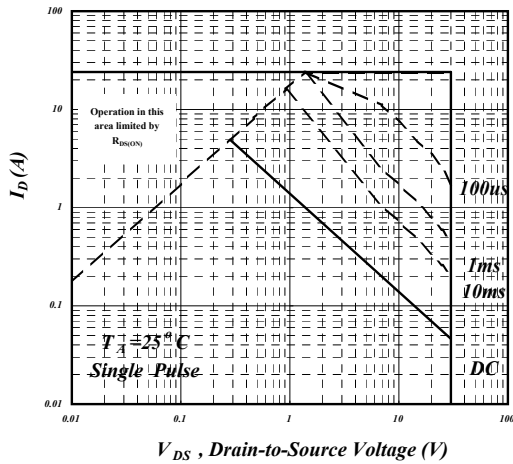

Fig 9. Maximum Safe Operating Area

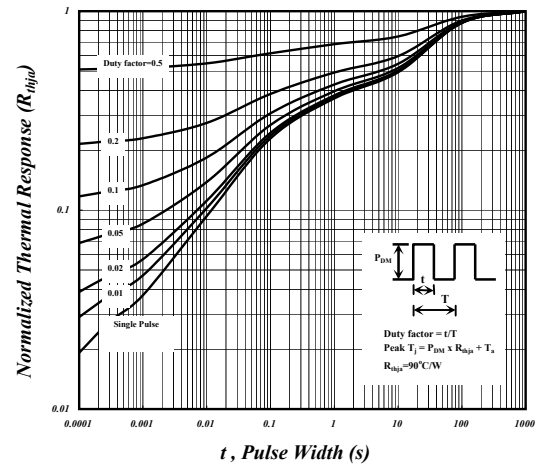

Fig 10. Effective Transient Thermal Impedance

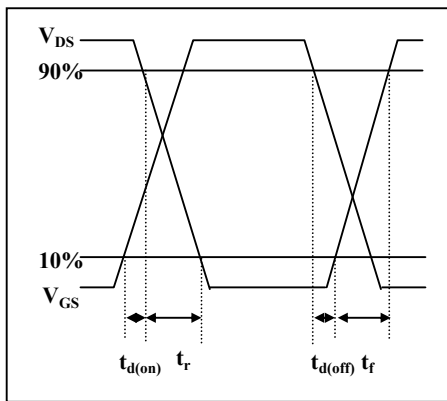

Fig 11. Switching Time Waveform

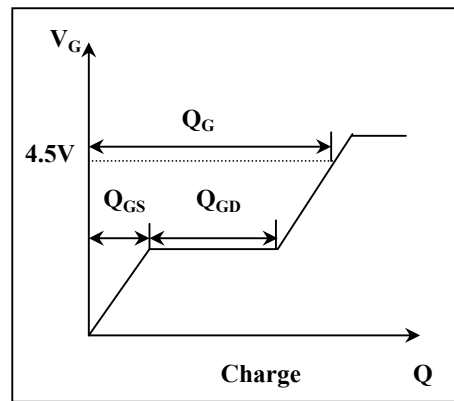

Fig 12. Gate Charge Waveform



AP3702YT

N-Channel

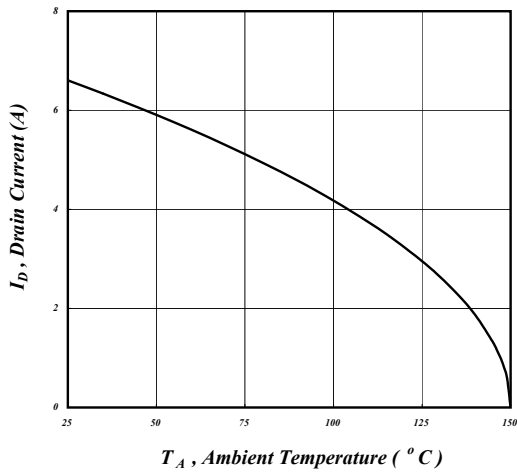

Fig 13. Drain Current v.s. Ambient Temperature

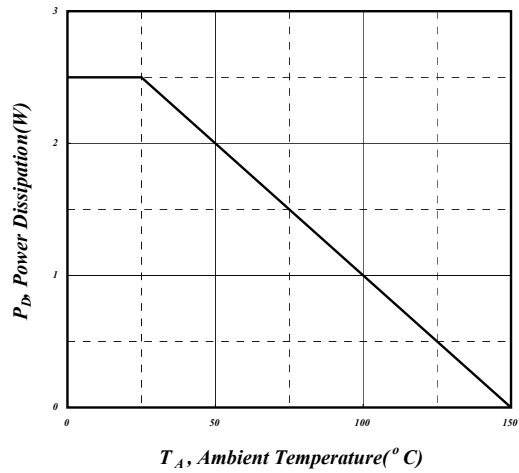

Fig 14. Total Power Dissipation

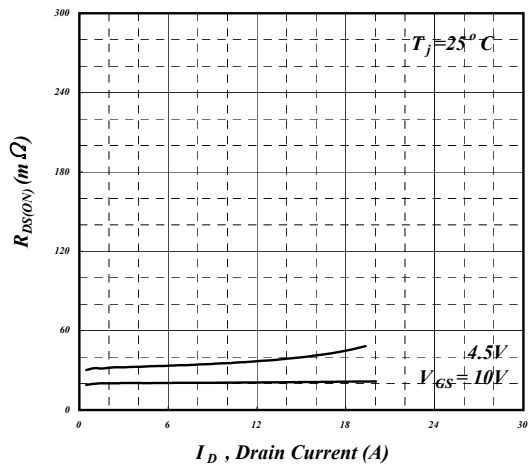

Fig 15. Typ. Drain-Source on State Resistance

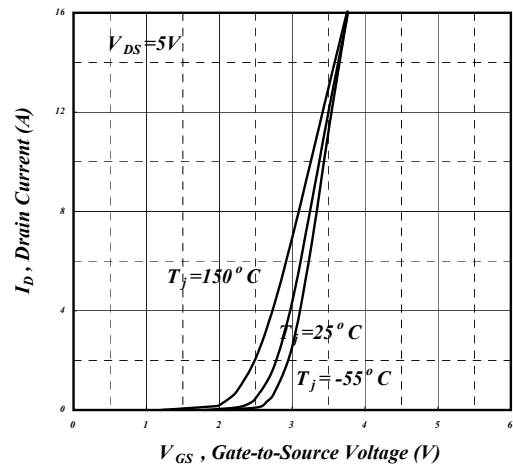

Fig 16. Transfer Characteristics



P-Channel

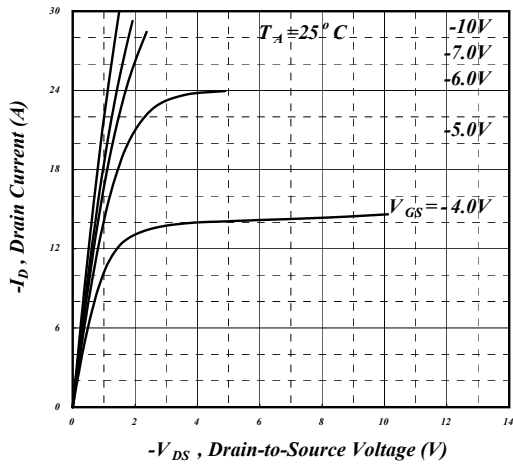

Fig 1. Typical Output Characteristics

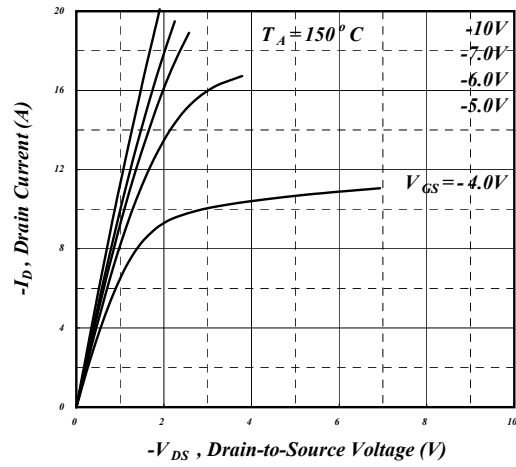

Fig 2. Typical Output Characteristics

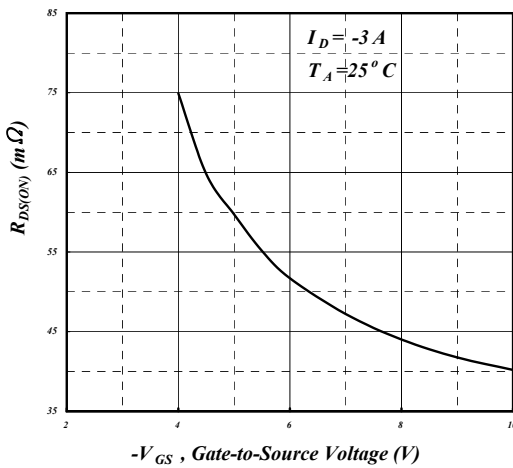

Fig 3. On-Resistance v.s. Gate Voltage

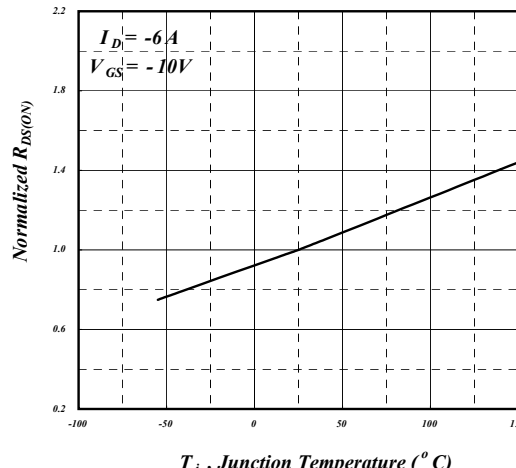

Fig 4. Normalized On-Resistance v.s. Junction Temperature

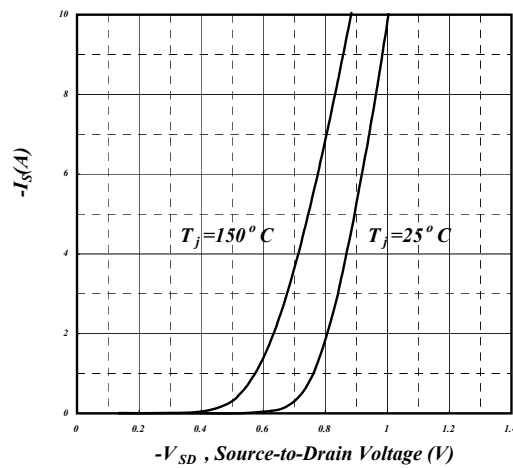

Fig 5. Forward Characteristic of Reverse Diode

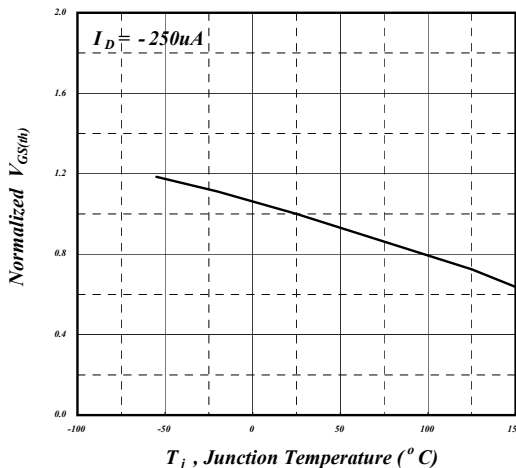

Fig 6. Gate Threshold Voltage v.s. Junction Temperature



AP3702YT

P-Channel

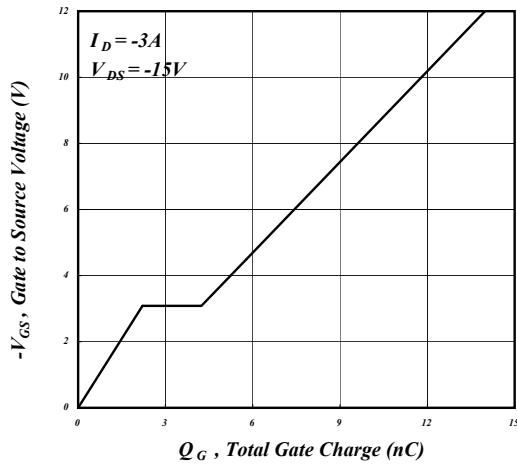

Fig 7. Gate Charge Characteristics

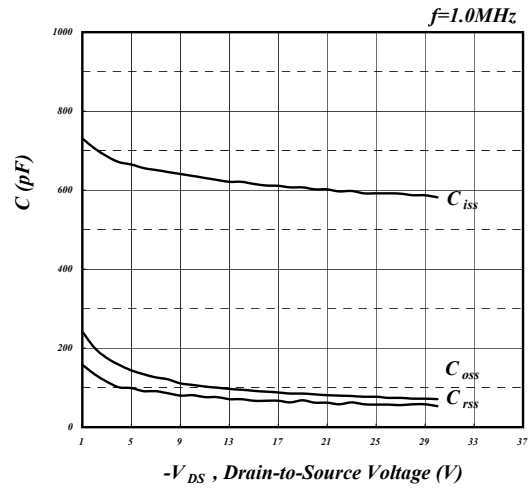

Fig 8. Typical Capacitance Characteristics

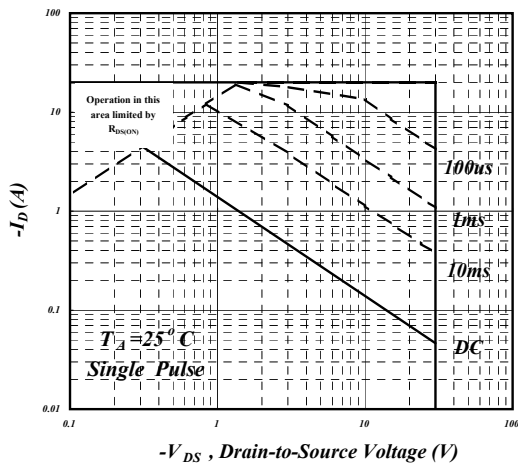

Fig 9. Maximum Safe Operating Area

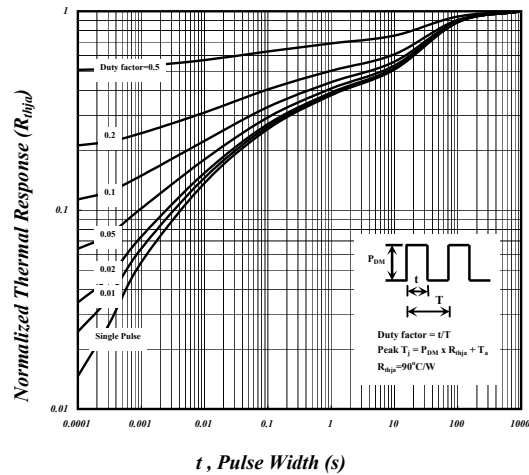

Fig 10. Effective Transient Thermal Impedance

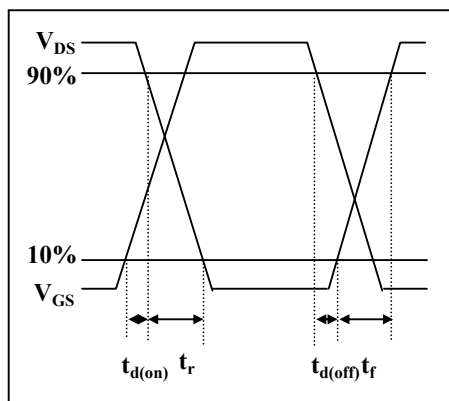

Fig 11. Switching Time Waveform

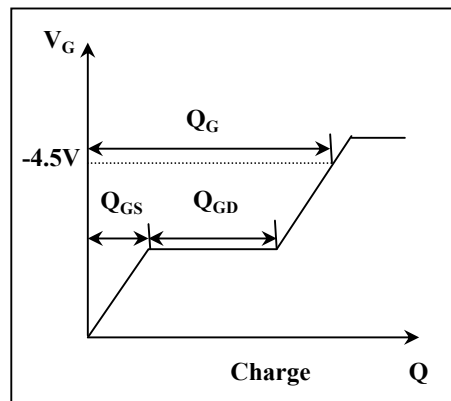

Fig 12. Gate Charge Waveform



P-Channel

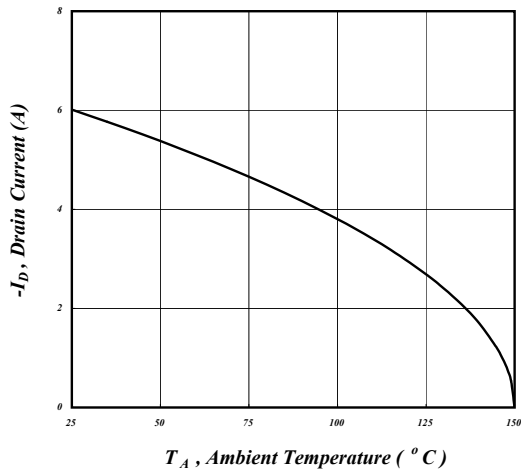

Fig 13. Drain Current v.s. Ambient Temperature

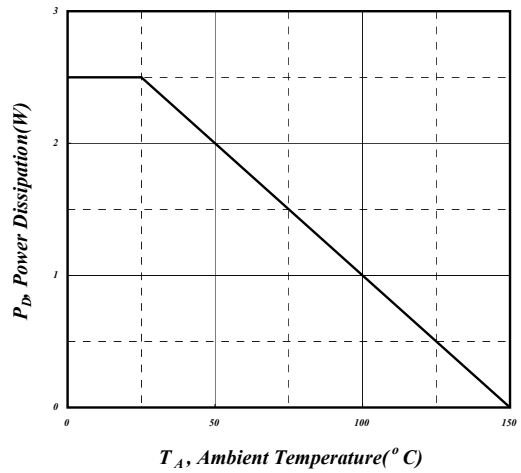

Fig 14. Total Power Dissipation

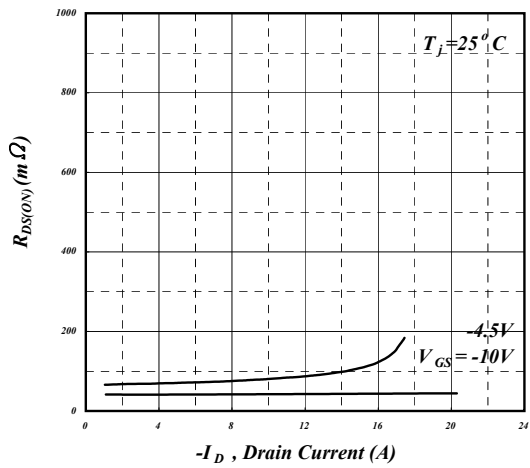

Fig 15. Typ. Drain-Source on State Resistance

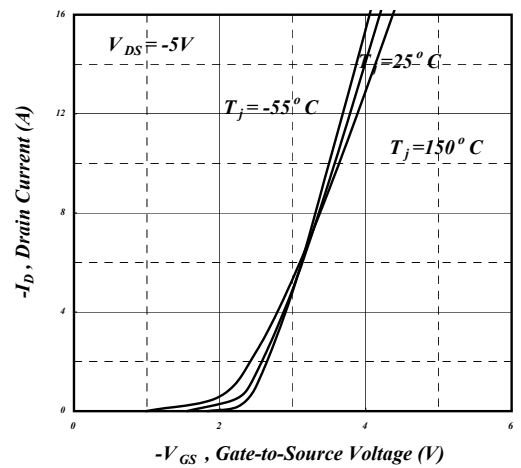
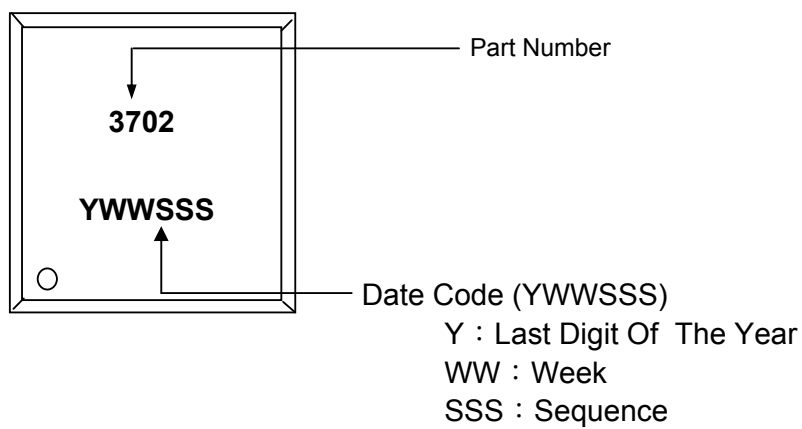

Fig 16. Transfer Characteristics



AP3702YT

MARKING INFORMATION





Package Outline : PMPAK 3x3 (Dual Pad)

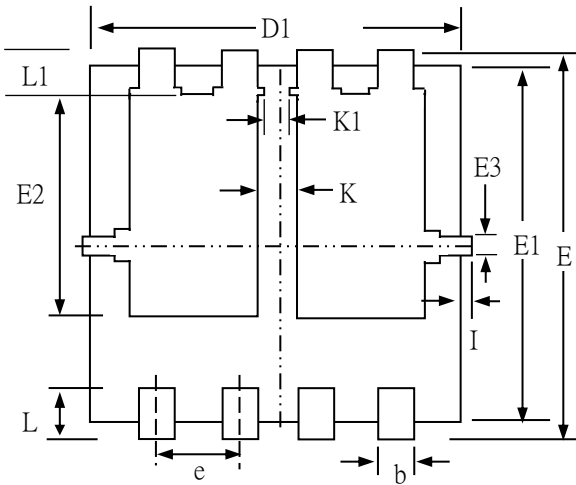

BACKSIDE VIEW

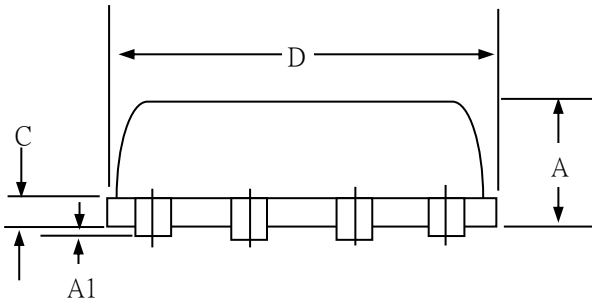

SYMBOLS	Millimeters		
	MIN	NOM	MAX
A	0.65	0.80	1.05
A1	-----	-----	0.15
b	0.20	0.35	0.50
C	0.10	0.15	0.25
D	2.85	3.30	3.60
D1	2.85	3.10	3.40
E	2.85	3.30	3.60
E1	2.85	3.10	3.40
E2	1.45	1.75	2.05
E3	0.10	0.20	0.30
e	0.65 (ref.)		
L	0.15	0.40	0.50
L1	0.15	0.50	0.70
K	0.20	0.38	0.65
K1	0.10	0.25	0.45
I	-----	-----	0.15

- 1.All Dimension Are In Millimeters.
- 2.Dimension Does Not Include Mold Protrusions.



PMPAK3X3(Dual Pad) FOOTPRINT :

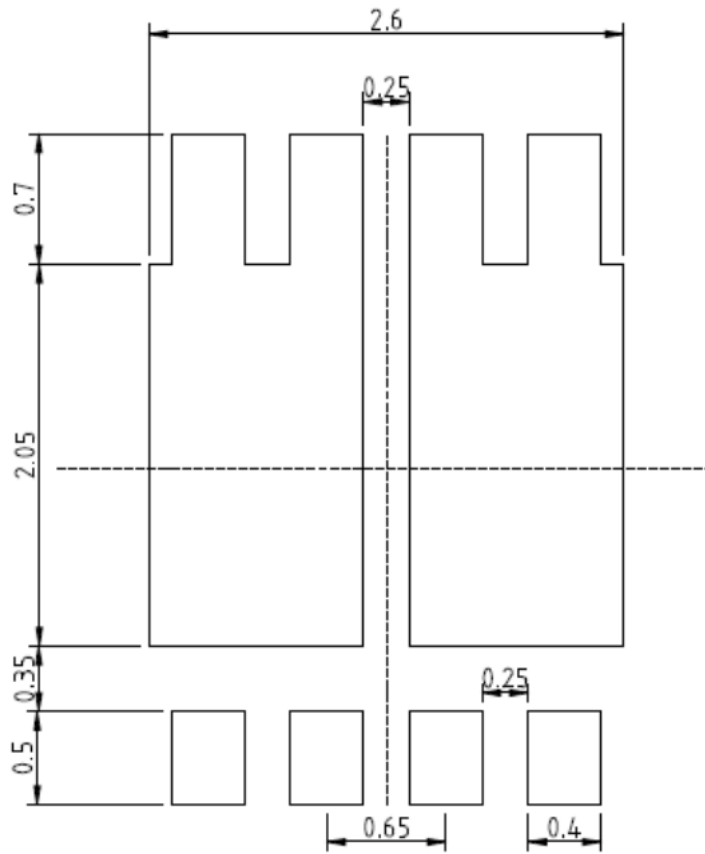

UNIT: mm