

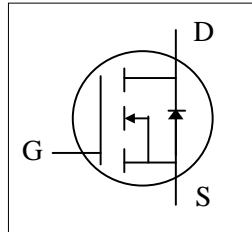

- ▼ 100% Avalanche Test
- ▼ Fast Switching Characteristic
- ▼ Simple Drive Requirement
- ▼ RoHS Compliant & Halogen-Free



BV_{DSS}	600V
$R_{DS(ON)}$	0.68Ω
I_D	10A

Description

AP3989 series are from Advanced Power innovated design and silicon process technology to achieve the lowest possible on-resistance and fast switching performance. It provides the designer with an extreme efficient device for use in a wide range of power applications.

The TO-262 package is widely preferred for commercial-industrial through-hole applications and suited for low voltage applications such as DC/DC converters.

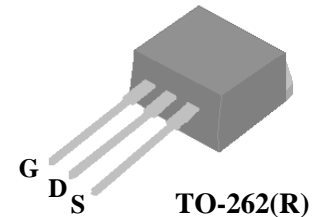

Absolute Maximum Ratings @ $T_j=25^\circ\text{C}$ (unless otherwise specified)

Symbol	Parameter	Rating	Units
V_{DS}	Drain-Source Voltage	600	V
V_{GS}	Gate-Source Voltage	± 30	V
$I_D @ T_C=25^\circ\text{C}$	Drain Current, V_{GS} @ 10V	10	A
$I_D @ T_C=100^\circ\text{C}$	Drain Current, V_{GS} @ 10V	5	A
I_{DM}	Pulsed Drain Current ¹	40	A
$P_D @ T_C=25^\circ\text{C}$	Total Power Dissipation	156	W
T_{STG}	Storage Temperature Range	-55 to 150	$^\circ\text{C}$
T_J	Operating Junction Temperature Range	-55 to 150	$^\circ\text{C}$

Thermal Data

Symbol	Parameter	Value	Unit
Rthj-c	Maximum Thermal Resistance, Junction-case	0.8	$^\circ\text{C}/\text{W}$
Rthj-a	Maximum Thermal Resistance, Junction-ambient	62	$^\circ\text{C}/\text{W}$



Electrical Characteristics @ T_j=25°C (unless otherwise specified)

Symbol	Parameter	Test Conditions	Min.	Typ.	Max.	Units
BV _{DSS}	Drain-Source Breakdown Voltage	V _{GS} =0V, I _D =250uA	600	-	-	V
R _{DS(ON)}	Static Drain-Source On-Resistance ²	V _{GS} =10V, I _D =5A	-	-	0.68	Ω
V _{GS(th)}	Gate Threshold Voltage	V _{DS} =V _{GS} , I _D =250uA	2	-	4	V
g _{fs}	Forward Transconductance	V _{DS} =10V, I _D =5A	-	4.5	-	S
I _{DSS}	Drain-Source Leakage Current	V _{DS} =480V, V _{GS} =0V	-	-	100	uA
	Drain-Source Leakage Current (T _j =125°C)	V _{DS} =480V, V _{GS} =0V	-	-	500	uA
I _{GSS}	Gate-Source Leakage	V _{GS} =±30V, V _{DS} =0V	-	-	±100	nA
Q _g	Total Gate Charge	I _D =9A	-	48	77	nC
Q _{gs}	Gate-Source Charge	V _{DS} =480V	-	10	-	nC
Q _{gd}	Gate-Drain ("Miller") Charge	V _{GS} =10V	-	20	-	nC
t _{d(on)}	Turn-on Delay Time	V _{DD} =300V	-	16	-	ns
t _r	Rise Time	I _D =9A	-	25	-	ns
t _{d(off)}	Turn-off Delay Time	R _G =10Ω, V _{GS} =10V	-	70	-	ns
t _f	Fall Time	R _D =33.3Ω	-	35	-	ns
C _{iss}	Input Capacitance	V _{GS} =0V	-	2150	3440	pF
C _{oss}	Output Capacitance	V _{DS} =25V	-	355	-	pF
C _{rss}	Reverse Transfer Capacitance	f=1.0MHz	-	28	-	pF

Source-Drain Diode

Symbol	Parameter	Test Conditions	Min.	Typ.	Max.	Units
V _{SD}	Forward On Voltage ²	I _S =9A, V _{GS} =0V	-	-	1.5	V
t _{rr}	Reverse Recovery Time	I _S =9A, V _{GS} =0V	-	570	-	ns
Q _{rr}	Reverse Recovery Charge	di/dt=100A/μs	-	9.7	-	uC

Notes:

1. Pulse width limited by Max. junction temperature.
2. Pulse test

THIS PRODUCT IS SENSITIVE TO ELECTROSTATIC DISCHARGE, PLEASE HANDLE WITH CAUTION.

USE OF THIS PRODUCT AS A CRITICAL COMPONENT IN LIFE SUPPORT OR OTHER SIMILAR SYSTEMS IS NOT AUTHORIZED.

APEC DOES NOT ASSUME ANY LIABILITY ARISING OUT OF THE APPLICATION OR USE OF ANY PRODUCT OR CIRCUIT DESCRIBED HEREIN; NEITHER DOES IT CONVEY ANY LICENSE UNDER ITS PATENT RIGHTS, NOR THE RIGHTS OF OTHERS.

APEC RESERVES THE RIGHT TO MAKE CHANGES WITHOUT FURTHER NOTICE TO ANY PRODUCTS HEREIN TO IMPROVE RELIABILITY, FUNCTION OR DESIGN.

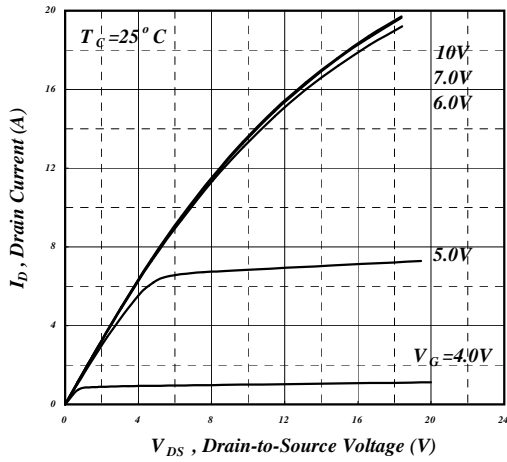

Fig 1. Typical Output Characteristics

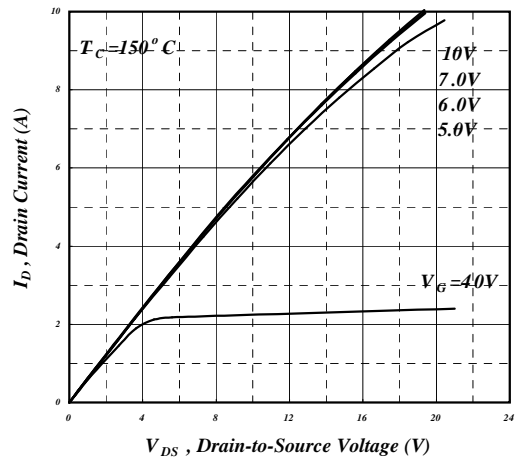

Fig 2. Typical Output Characteristics

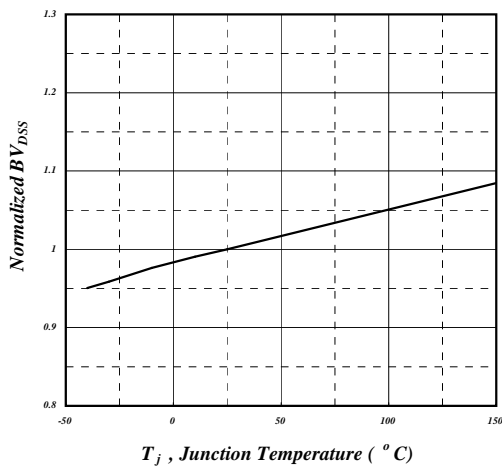

Fig 3. Normalized BV_{DSS} v.s. Junction Temperature

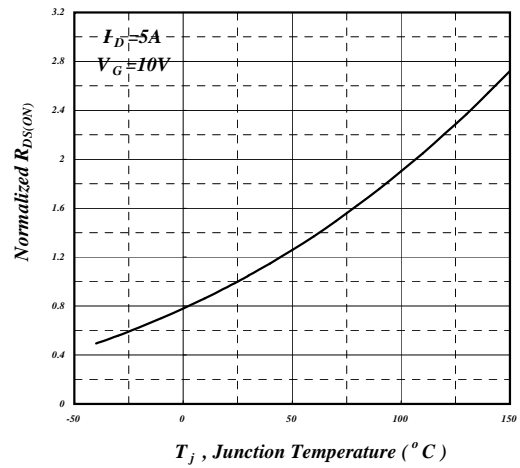

Fig 4. Normalized On-Resistance v.s. Junction Temperature

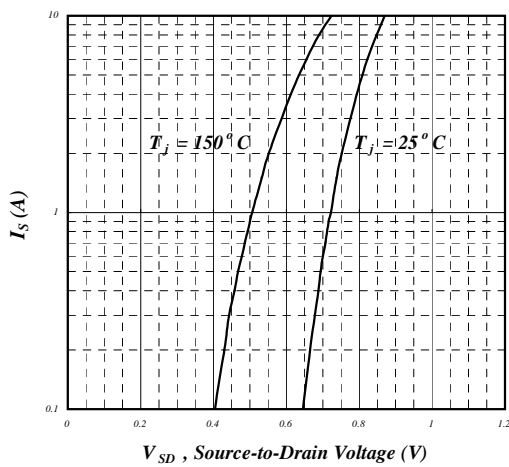

Fig 5. Forward Characteristic of Reverse Diode

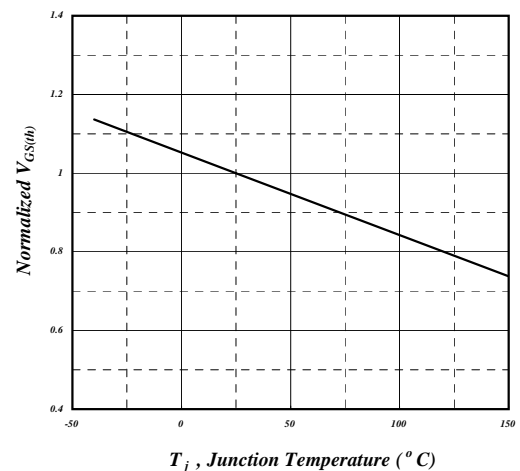

Fig 6. Gate Threshold Voltage v.s. Junction Temperature



AP3989R-HF

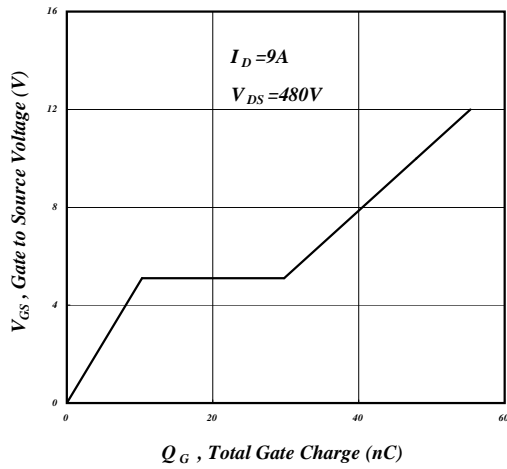

Fig 7. Gate Charge Characteristics

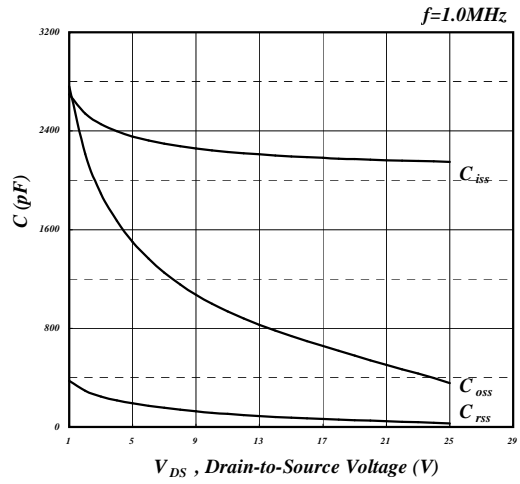

Fig 8. Typical Capacitance Characteristics

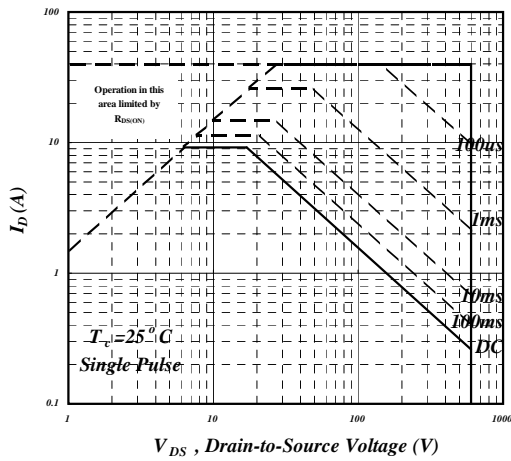

Fig 9. Maximum Safe Operating Area

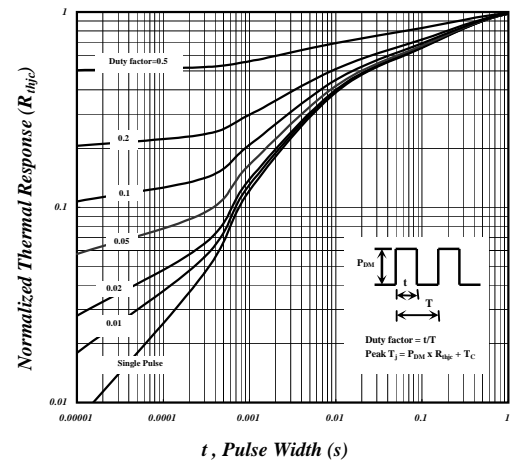

Fig 10. Effective Transient Thermal Impedance

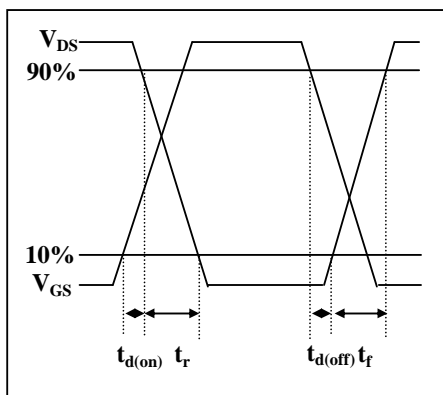

Fig 11. Switching Time Waveform

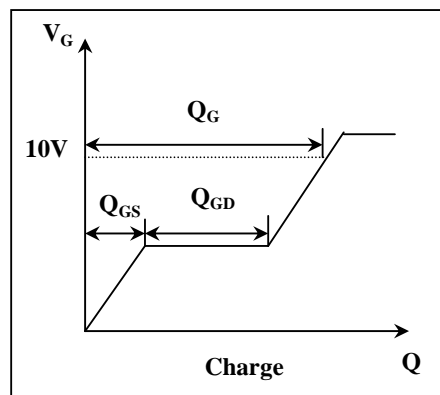
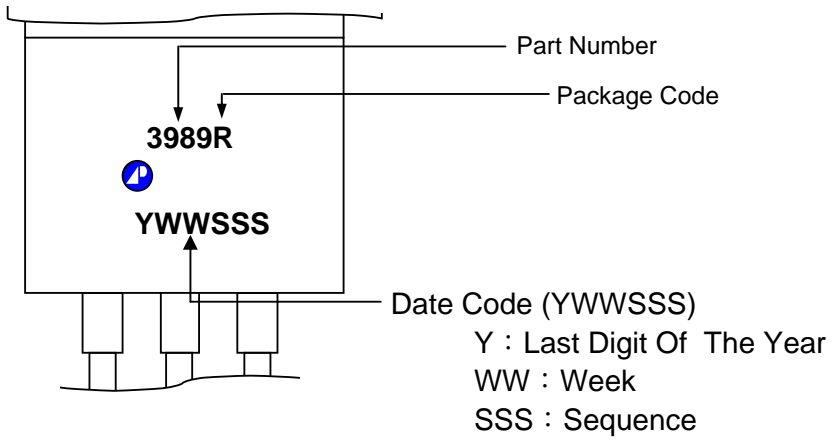

Fig 12. Gate Charge Waveform



MARKING INFORMATION





Package Outline : TO-262

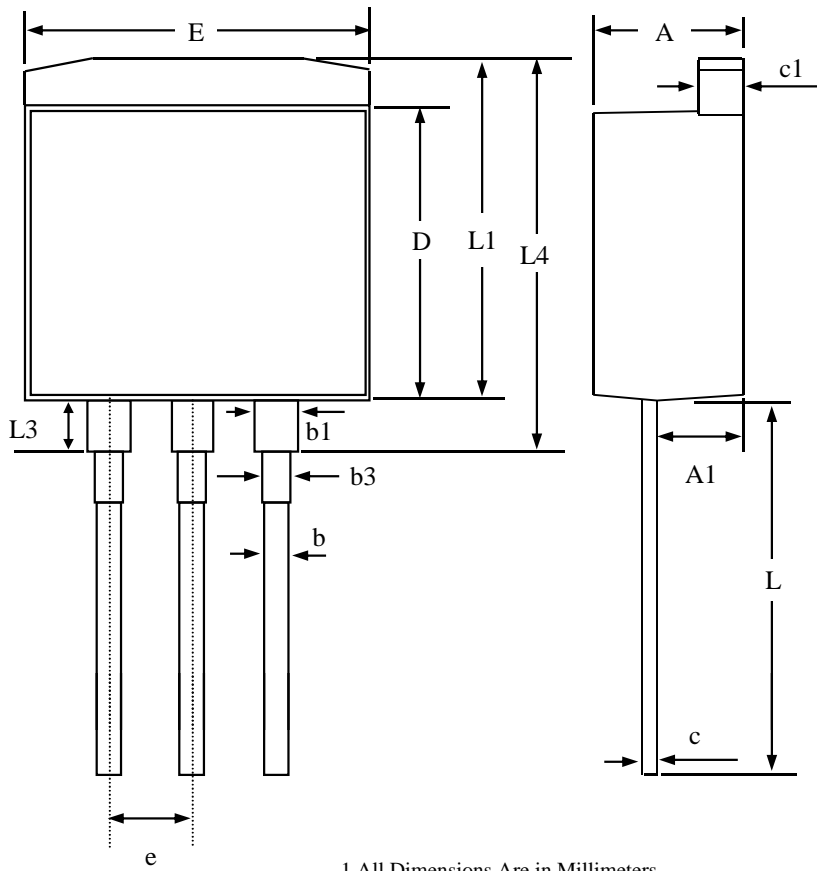

SYMBOLS	Millimeters		
	MIN	NOM	MAX
A	4.24	4.54	4.84
A1	2.10	2.50	2.90
b	0.65	0.85	1.05
b1	0.63	1.08	1.53
b3	0.75	1.08	1.40
c	0.30	0.45	0.60
c1	1.15	1.3	1.45
D	8.30	8.9	9.50
E	9.50	10	10.50
e	2.04	2.54	3.04
L	10.50	12.5	14.50
L1	8.50	10	11.50
L3	1.3 ~ 4.8 (ref)		

- 1.All Dimensions Are in Millimeters.
- 2.Dimension Does Not Include Mold Protrusions.



TO-262 FOOTPRINT :

