



**Advanced Power  
Electronics Corp.**

**AP3A010AMT**

**Halogen-Free Product**

*DUAL N-CHANNEL ENHANCEMENT*

*MODE POWER MOSFET*

- ▼ Simple Drive Requirement
- ▼ Fast Switching Characteristic
- ▼ RoHS Compliant & Halogen-Free

### Description

AP3A010A series are from Advanced Power innovated design and silicon process technology to achieve the lowest possible on-resistance and fast switching performance. It provides the designer with an extreme efficient device fo

PMPAK<sup>®</sup> 5x6 dual pad provide superior thermal performance and is design for surface mount applications.

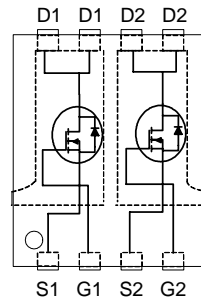

$BV_{DSS}$	30V
$R_{DS(ON)}$	10.4m $\Omega$

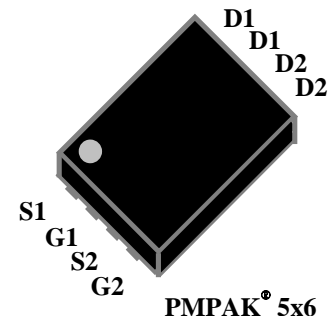

### Absolute Maximum Ratings

Symbol	Parameter	Rating	Units
$V_{DS}$	Drain-Source Voltage	30	V
$V_{GS}$	Gate-Source Voltage	+20	V
$I_D @ T_C = 25^\circ C$	Drain Current, $V_{GS} @ 10V^4$	35	A
$I_D @ T_A = 25^\circ C$	Drain Current <sup>3</sup> , $V_{GS} @ 10V$	12	A
$I_D @ T_A = 70^\circ C$	Drain Current <sup>3</sup> , $V_{GS} @ 10V$	11.5	A
$I_{DM}$	Pulsed Drain Current <sup>1</sup>	50	A
$P_D @ T_A = 25^\circ C$	Total Power Dissipation	3.57	W
$T_{STG}$	Storage Temperature Range	-55 to 150	$^\circ C$
$T_J$	Operating Junction Temperature Range	-55 to 150	$^\circ C$

### Thermal Data

Symbol	Parameter	Rating	Units
Rthj-c	Maximum Thermal Resistance, Junction-case	6	$^\circ C/W$
Rthj-a	Maximum Thermal Resistance, Junction-ambient <sup>3</sup>	35	$^\circ C/W$



# AP3A010AMT

## Electrical Characteristics @T<sub>j</sub>=25°C(unless otherwise specified)

Symbol	Parameter	Test Conditions	Min.	Typ.	Max.	Units
BV <sub>DSS</sub>	Drain-Source Breakdown Voltage	V <sub>GS</sub> =0V, I <sub>D</sub> =250uA	30	-	-	V
R <sub>DS(ON)</sub>	Static Drain-Source On-Resistance <sup>2</sup>	V <sub>GS</sub> =10V, I <sub>D</sub> =12A	-	-	10.4	mΩ
		V <sub>GS</sub> =4.5V, I <sub>D</sub> =7A	-	-	15.3	mΩ
V <sub>GS(th)</sub>	Gate Threshold Voltage	V <sub>DS</sub> =V <sub>GS</sub> , I <sub>D</sub> =1mA	1.45	-	3	V
g <sub>fs</sub>	Forward Transconductance	V <sub>DS</sub> =5V, I <sub>D</sub> =10A	-	40	-	S
I <sub>DSS</sub>	Drain-Source Leakage Current	V <sub>DS</sub> =24V, V <sub>GS</sub> =0V	-	-	25	uA
I <sub>GSS</sub>	Gate-Source Leakage	V <sub>GS</sub> =±20V, V <sub>DS</sub> =0V	-	-	±100	nA
Q <sub>g</sub>	Total Gate Charge	I <sub>D</sub> =7A	-	14	22.4	nC
Q <sub>gs</sub>	Gate-Source Charge	V <sub>DS</sub> =15V	-	4.5	-	nC
Q <sub>gd</sub>	Gate-Drain ("Miller") Charge	V <sub>GS</sub> =4.5V	-	5.3	-	nC
t <sub>d(on)</sub>	Turn-on Delay Time	V <sub>DS</sub> =15V	-	9	-	ns
t <sub>r</sub>	Rise Time	I <sub>D</sub> =1A	-	8	-	ns
t <sub>d(off)</sub>	Turn-off Delay Time	R <sub>G</sub> =3.3Ω	-	29	-	ns
t <sub>f</sub>	Fall Time	V <sub>GS</sub> =10V	-	9	-	ns
C <sub>iss</sub>	Input Capacitance	V <sub>GS</sub> =0V	-	1530	2448	pF
C <sub>oss</sub>	Output Capacitance	V <sub>DS</sub> =15V	-	225	-	pF
C <sub>rss</sub>	Reverse Transfer Capacitance	f=1.0MHz	-	160	-	pF
R <sub>g</sub>	Gate Resistance	f=1.0MHz	-	2.5	5	Ω

## Source-Drain Diode

Symbol	Parameter	Test Conditions	Min.	Typ.	Max.	Units
V <sub>SD</sub>	Forward On Voltage <sup>2</sup>	I <sub>S</sub> =2.9A, V <sub>GS</sub> =0V	-	-	1.2	V
t <sub>rr</sub>	Reverse Recovery Time	I <sub>S</sub> =12A, V <sub>GS</sub> =0V,	-	11	-	ns
Q <sub>rr</sub>	Reverse Recovery Charge	dI/dt=100A/μs	-	4	-	nC

### Notes:

- 1.Pulse width limited by Max. junction temperature.
- 2.Pulse test
- 3.Surface mounted on 1 in<sup>2</sup> copper pad of FR4 board, t ≤10sec ; 85 °C/W on steady state.
- 4.Package limitation current is 12A .

THIS PRODUCT IS SENSITIVE TO ELECTROSTATIC DISCHARGE, PLEASE HANDLE WITH CAUTION.

USE OF THIS PRODUCT AS A CRITICAL COMPONENT IN LIFE SUPPORT OR OTHER SIMILAR SYSTEMS IS NOT AUTHORIZED.

APEC DOES NOT ASSUME ANY LIABILITY ARISING OUT OF THE APPLICATION OR USE OF ANY PRODUCT OR CIRCUIT DESCRIBED HEREIN; NEITHER DOES IT CONVEY ANY LICENSE UNDER ITS PATENT RIGHTS, NOR THE RIGHTS OF OTHERS.

APEC RESERVES THE RIGHT TO MAKE CHANGES WITHOUT FURTHER NOTICE TO ANY PRODUCTS HEREIN TO IMPROVE RELIABILITY, FUNCTION OR DESIGN.

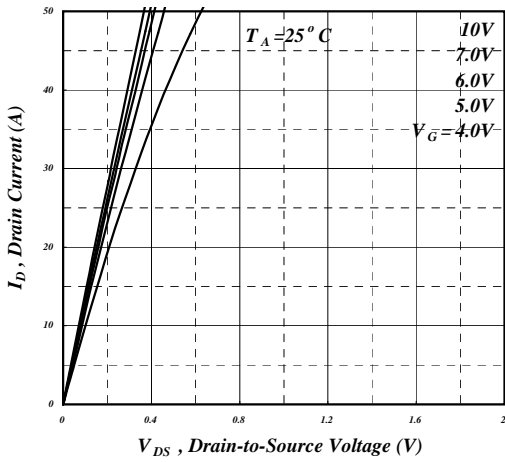

Fig 1. Typical Output Characteristics

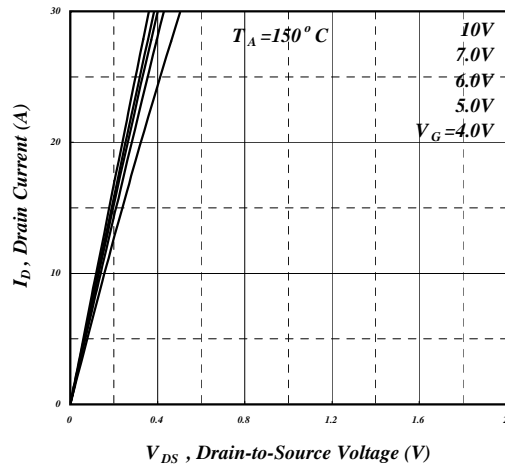

Fig 2. Typical Output Characteristics

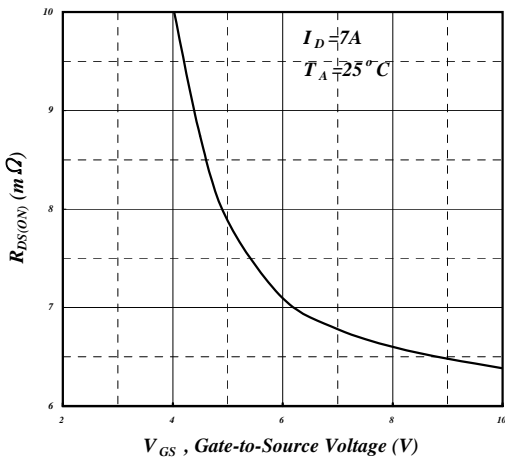

Fig 3. On-Resistance v.s. Gate Voltage

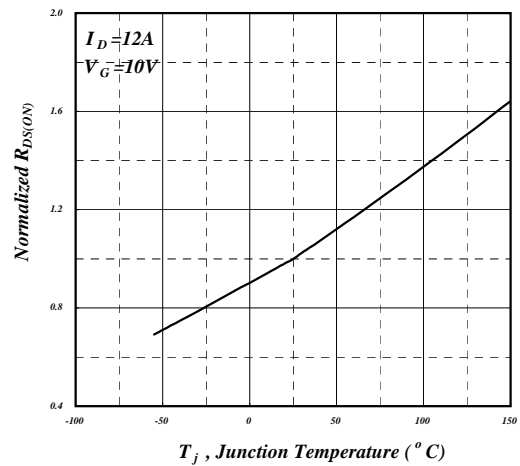

Fig 4. Normalized On-Resistance v.s. Junction Temperature

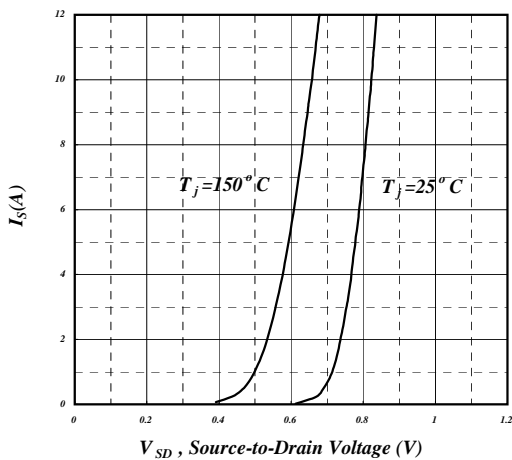

Fig 5. Forward Characteristic of Reverse Diode

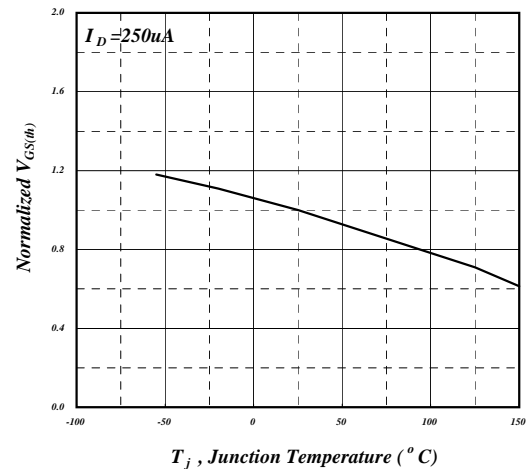

Fig 6. Gate Threshold Voltage v.s. Junction Temperature

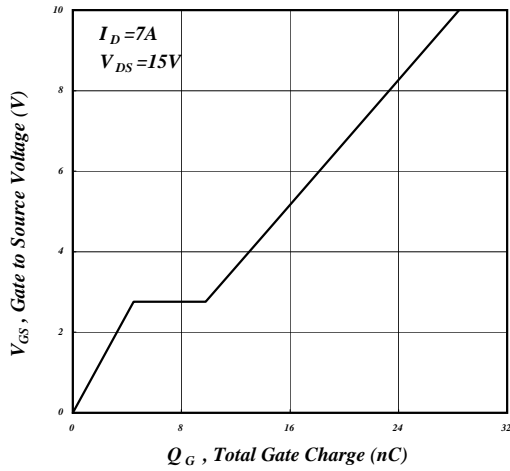

Fig 7. Gate Charge Characteristics

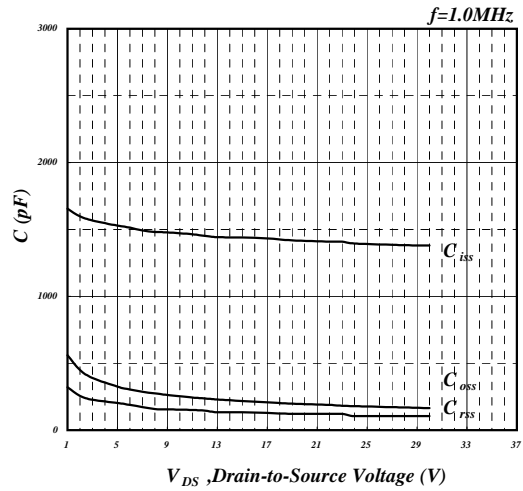

Fig 8. Typical Capacitance Characteristics

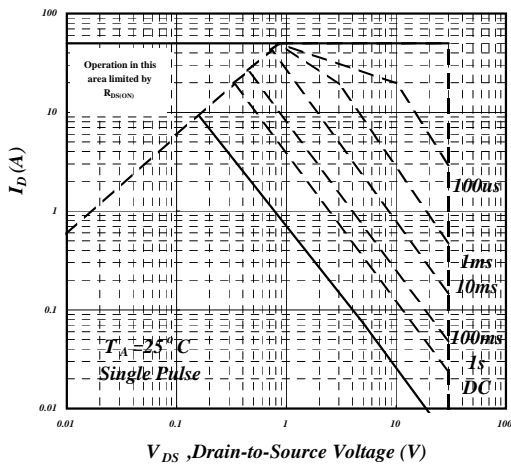

Fig 9. Maximum Safe Operating Area

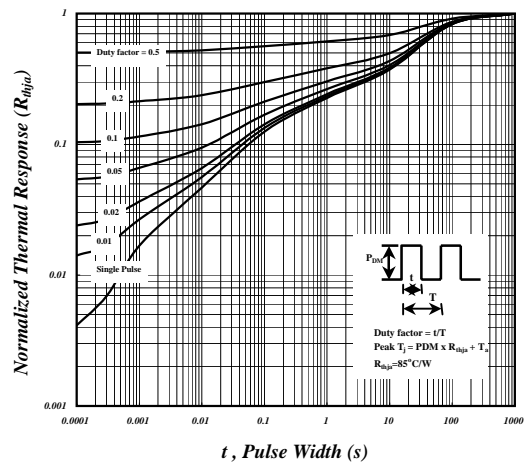

Fig 10. Effective Transient Thermal Impedance

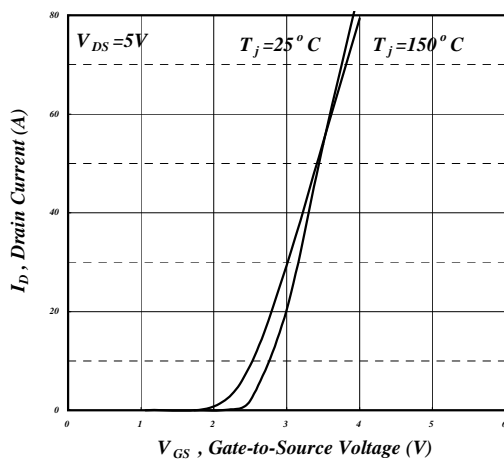

Fig 11. Transfer Characteristics

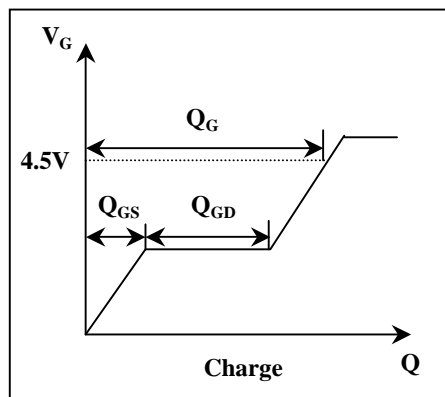
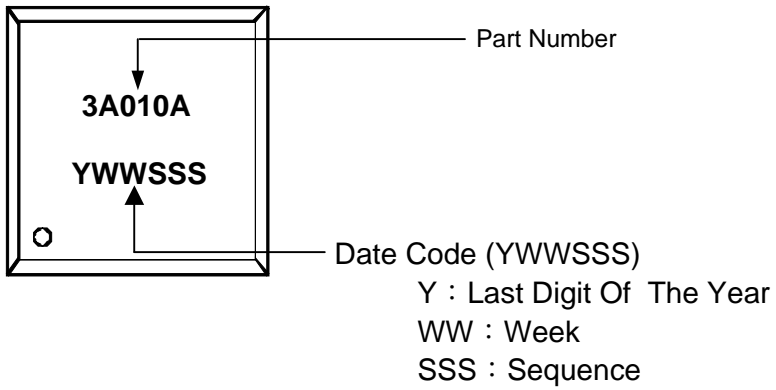

Fig 12. Gate Charge Waveform



---

**MARKING INFORMATION**



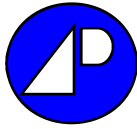

## Package Outline : PMPAK 5x6 (Dual Pad)

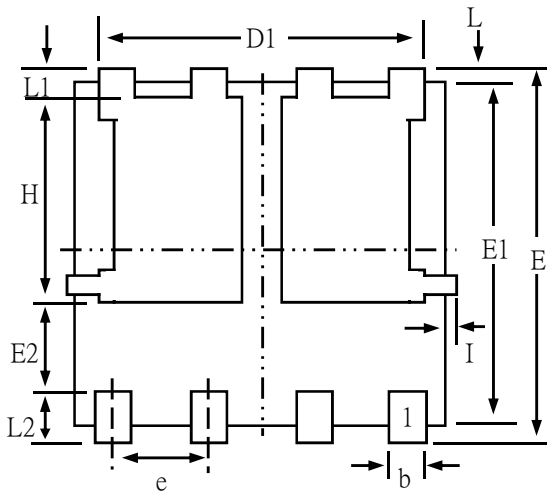

BACKSIDE VIEW

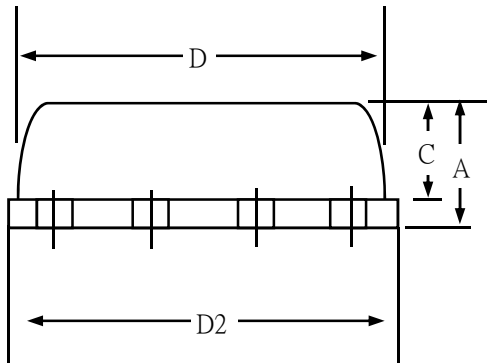

SYMBOLS	Millimeters		
	MIN	NOM	MAX
A	0.80	1.00	1.20
b	0.34	0.42	0.50
C	0.54	0.76	0.97
D	4.80	4.95	5.10
D1	4.11	4.21	4.31
E	5.90	6.05	6.20
E1	5.60	5.75	5.90
E2	1.60 (ref.)		
e	1.27 (ref.)		
L	0.05	0.15	0.25
L1	0.60 (ref.)		
L2	0.60 (ref.)		
H	3.60 (ref.)		
I	0.15 (ref.)		
D2	4.80	5.15	5.50

1.All Dimension Are In Millimeters.

2.Dimension Does Not Include Mold Protrusions.



**PMPAK5X6(Dual Pad,左右) FOOTPRINT :**

