

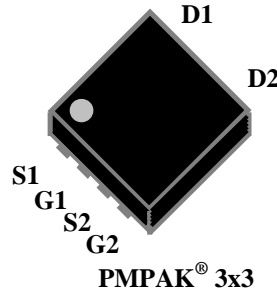

- ▼ Simple Drive Requirement
- ▼ Good Thermal Performance
- ▼ Fast Switching Performance
- ▼ RoHS Compliant & Halogen-Free



N-CH	BV_{DSS}	30V
	$R_{DS(ON)}$	23m Ω
P-CH	BV_{DSS}	-30V
	$R_{DS(ON)}$	60m Ω

Description

AP3C020 series are from Advanced Power innovated design and silicon process technology to achieve the lowest possible on-resistance and fast switching performance. It provides the designer with an extreme efficient device for use in a wide range of power applications.

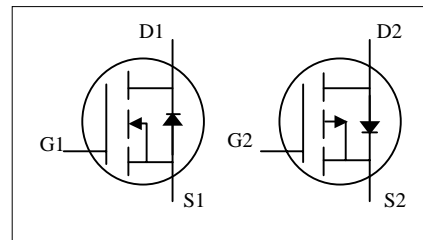

The PMPAK[®] 3x3 package is special for voltage conversion application using standard infrared reflow technique with the backside heat sink to achieve the good thermal performance.

Absolute Maximum Ratings @ $T_J=25^\circ\text{C}$ (unless otherwise specified)

Symbol	Parameter	Rating		Units
		N-channel	P-channel	
V_{DS}	Drain-Source Voltage	30	-30	V
V_{GS}	Gate-Source Voltage	± 20	± 20	V
$I_D @ T_C=25^\circ\text{C}$	Drain Current, $V_{GS} @ 10\text{V}$	18.2	-11.8	A
$I_D @ T_C=100^\circ\text{C}$	Drain Current, $V_{GS} @ 10\text{V}$	11.5	-7.4	A
$I_D @ T_A=25^\circ\text{C}$	Drain Current ³ , $V_{GS} @ 10\text{V}$	8.1	-5.2	A
$I_D @ T_A=70^\circ\text{C}$	Drain Current ³ , $V_{GS} @ 10\text{V}$	6.5	-4.2	A
I_{DM}	Pulsed Drain Current ¹	30	-20	A
$P_D @ T_A=25^\circ\text{C}$	Total Power Dissipation	2.5		W
T_{STG}	Storage Temperature Range	-55 to 150		$^\circ\text{C}$
T_J	Operating Junction Temperature Range	-55 to 150		$^\circ\text{C}$

Thermal Data

Symbol	Parameter	Value	Unit
Rthj-c	Maximum Thermal Resistance, Junction-case	10	$^\circ\text{C}/\text{W}$
Rthj-a	Maximum Thermal Resistance, Junction-ambient ³	50	$^\circ\text{C}/\text{W}$



AP3C020YT

N-CH Electrical Characteristics @T_j=25°C(unless otherwise specified)

Symbol	Parameter	Test Conditions	Min.	Typ.	Max.	Units
BV _{DSS}	Drain-Source Breakdown Voltage	V _{GS} =0V, I _D =250uA	30	-	-	V
R _{DS(ON)}	Static Drain-Source On-Resistance ²	V _{GS} =10V, I _D =8A	-	-	23	mΩ
		V _{GS} =4.5V, I _D =5A	-	-	42	mΩ
V _{GS(th)}	Gate Threshold Voltage	V _{DS} =V _{GS} , I _D =250uA	1	-	3	V
g _{fs}	Forward Transconductance	V _{DS} =5V, I _D =8A	-	16	-	S
I _{DSS}	Drain-Source Leakage Current	V _{DS} =24V, V _{GS} =0V	-	-	10	uA
I _{GSS}	Gate-Source Leakage	V _{GS} =±20V, V _{DS} =0V	-	-	±100	nA
Q _g	Total Gate Charge	I _D =5A V _{DS} =15V V _{GS} =4.5V	-	6.3	10	nC
Q _{gs}	Gate-Source Charge		-	1.8	-	nC
Q _{gd}	Gate-Drain ("Miller") Charge		-	3.2	-	nC
t _{d(on)}	Turn-on Delay Time	V _{DS} =15V I _D =1A	-	6	-	ns
t _r	Rise Time		-	10	-	ns
t _{d(off)}	Turn-off Delay Time	R _G =3.3Ω V _{GS} =10V	-	16	-	ns
t _f	Fall Time		-	4	-	ns
C _{iss}	Input Capacitance	V _{GS} =0V	-	420	672	pF
C _{oss}	Output Capacitance	V _{DS} =15V	-	90	-	pF
C _{rss}	Reverse Transfer Capacitance	f=1.0MHz	-	80	-	pF

Source-Drain Diode

Symbol	Parameter	Test Conditions	Min.	Typ.	Max.	Units
V _{SD}	Forward On Voltage ²	I _S =2A, V _{GS} =0V	-	-	1.2	V
t _{rr}	Reverse Recovery Time	I _S =8A, V _{GS} =0V dI/dt=100A/μs	-	13	-	ns
Q _{rr}	Reverse Recovery Charge		-	4	-	nC

**P-CH Electrical Characteristics @ $T_j=25^\circ\text{C}$ (unless otherwise specified)**

Symbol	Parameter	Test Conditions	Min.	Typ.	Max.	Unit
BV_{DSS}	Drain-Source Breakdown Voltage	$V_{GS}=0V, I_D=-250\mu A$	-30	-	-	V
$R_{DS(ON)}$	Static Drain-Source On-Resistance ²	$V_{GS}=-10V, I_D=-5A$	-	-	60	$m\Omega$
		$V_{GS}=-4.5V, I_D=-3A$	-	-	90	$m\Omega$
$V_{GS(th)}$	Gate Threshold Voltage	$V_{DS}=V_{GS}, I_D=-250\mu A$	-1	-	-3	V
g_{fs}	Forward Transconductance	$V_{DS}=-5V, I_D=-5A$	-	11	-	S
I_{DSS}	Drain-Source Leakage Current	$V_{DS}=-24V, V_{GS}=0V$	-	-	-10	μA
I_{GSS}	Gate-Source Leakage	$V_{GS}=\pm 20V, V_{DS}=0V$	-	-	± 100	nA
Q_g	Total Gate Charge	$I_D=-3A$	-	7	11.2	nC
Q_{gs}	Gate-Source Charge	$V_{DS}=-15V$	-	2.4	-	nC
Q_{gd}	Gate-Drain ("Miller") Charge	$V_{GS}=-4.5V$	-	2.8	-	nC
$t_{d(on)}$	Turn-on Delay Time	$V_{DS}=-15V$	-	9	-	ns
t_r	Rise Time	$I_D=-1A$	-	10	-	ns
$t_{d(off)}$	Turn-off Delay Time	$R_G=3.3\Omega$	-	24	-	ns
t_f	Fall Time	$V_{GS}=-10V$	-	5	-	ns
C_{iss}	Input Capacitance	$V_{GS}=0V$	-	625	1000	pF
C_{oss}	Output Capacitance	$V_{DS}=-15V$	-	95	-	pF
C_{rss}	Reverse Transfer Capacitance	$f=1.0\text{MHz}$	-	85	-	pF

Source-Drain Diode

Symbol	Parameter	Test Conditions	Min.	Typ.	Max.	Unit
V_{SD}	Forward On Voltage ²	$I_S=-2A, V_{GS}=0V$	-	-	-1.2	V
t_{rr}	Reverse Recovery Time	$I_S=-5A, V_{GS}=0V$	-	18	-	ns
Q_{rr}	Reverse Recovery Charge	$dI/dt=-100A/\mu s$	-	8	-	nC

Notes:

1. Pulse width limited by Max. junction temperature.
2. Pulse test
3. Surface mounted on 1 in² copper pad of FR4 board, $t \leq 10\text{sec}$, 90°C/W at steady state.

THIS PRODUCT IS SENSITIVE TO ELECTROSTATIC DISCHARGE, PLEASE HANDLE WITH CAUTION.

USE OF THIS PRODUCT AS A CRITICAL COMPONENT IN LIFE SUPPORT OR OTHER SIMILAR SYSTEMS IS NOT AUTHORIZED.

APEC DOES NOT ASSUME ANY LIABILITY ARISING OUT OF THE APPLICATION OR USE OF ANY PRODUCT OR CIRCUIT DESCRIBED HEREIN; NEITHER DOES IT CONVEY ANY LICENSE UNDER ITS PATENT RIGHTS, NOR THE RIGHTS OF OTHERS.

APEC RESERVES THE RIGHT TO MAKE CHANGES WITHOUT FURTHER NOTICE TO ANY PRODUCTS HEREIN TO IMPROVE RELIABILITY, FUNCTION OR DESIGN.



N-Channel

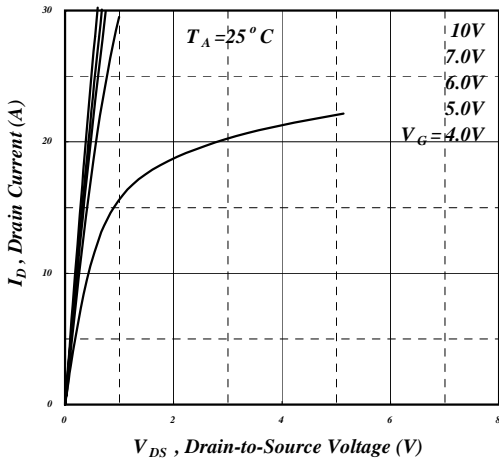

Fig 1. Typical Output Characteristics

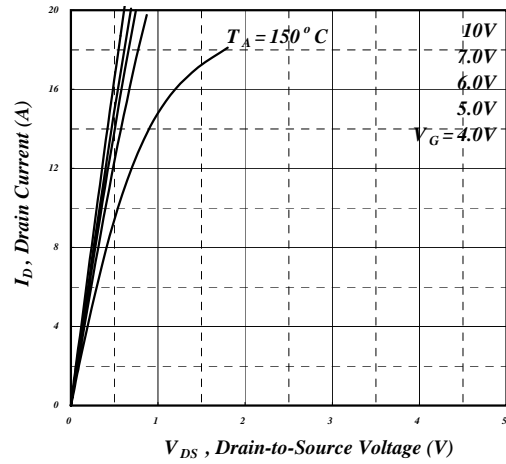

Fig 2. Typical Output Characteristics

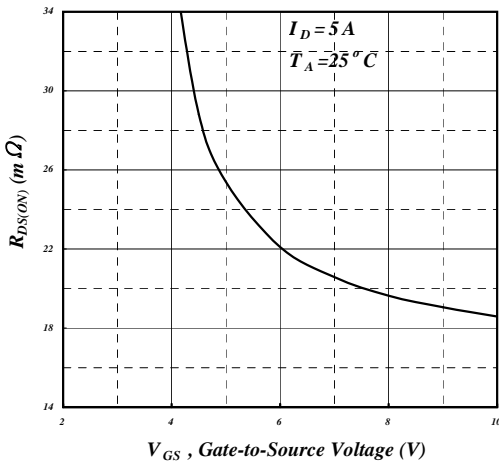

Fig 3. On-Resistance v.s. Gate Voltage

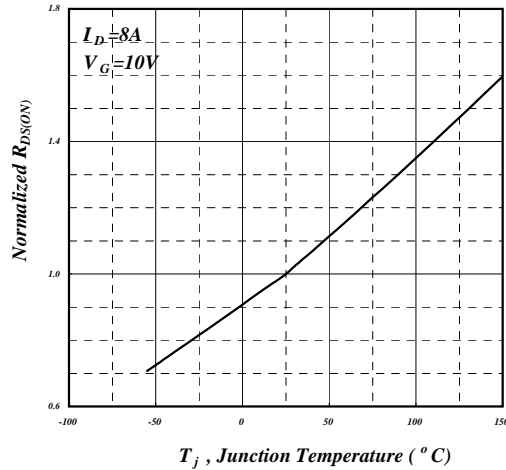

Fig 4. Normalized On-Resistance v.s. Junction Temperature

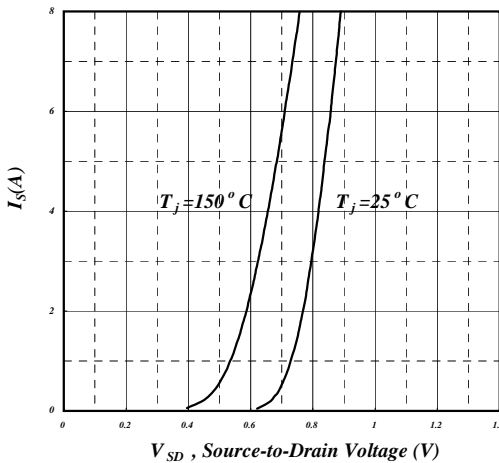

Fig 5. Forward Characteristic of Reverse Diode

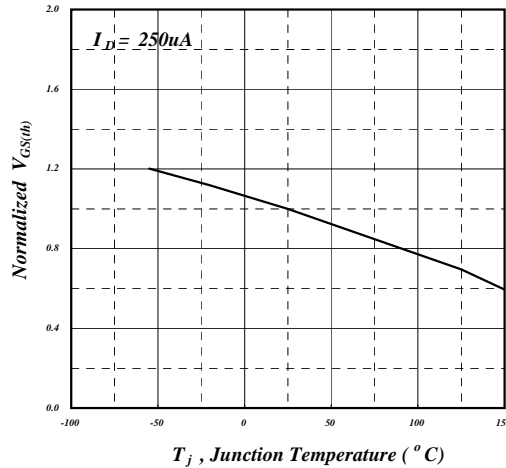

Fig 6. Gate Threshold Voltage v.s. Junction Temperature



N-Channel

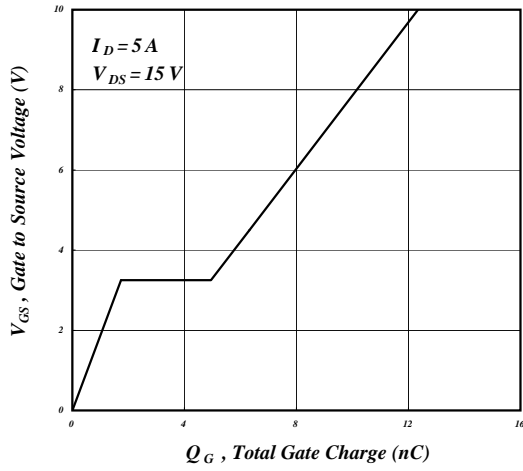

Fig 7. Gate Charge Characteristics

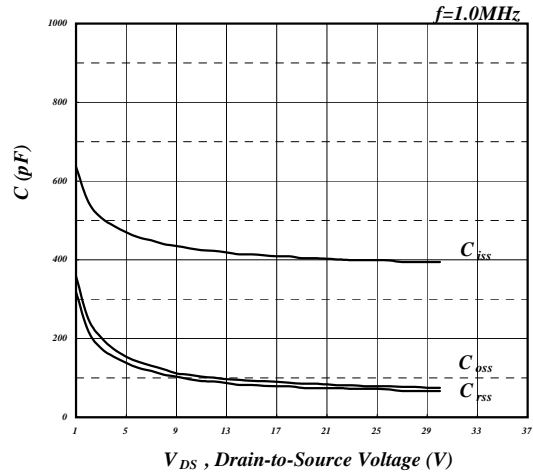

Fig 8. Typical Capacitance Characteristics

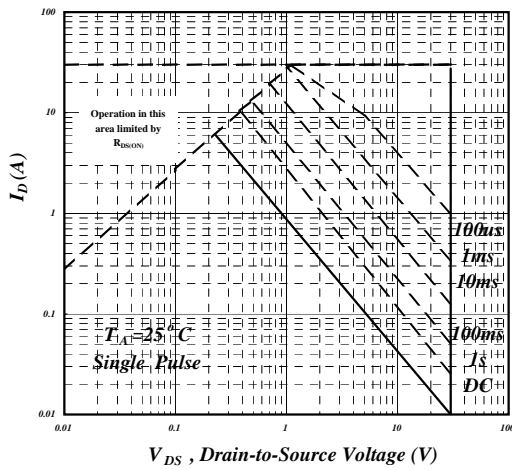

Fig 9. Maximum Safe Operating Area

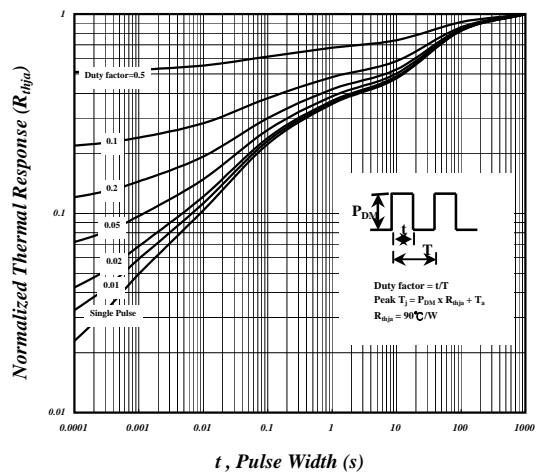

Fig 10. Effective Transient Thermal Impedance

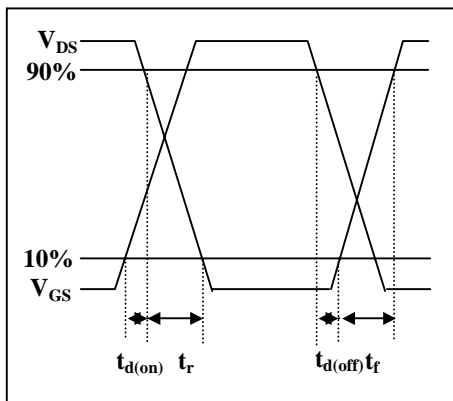

Fig 11. Switching Time Waveform

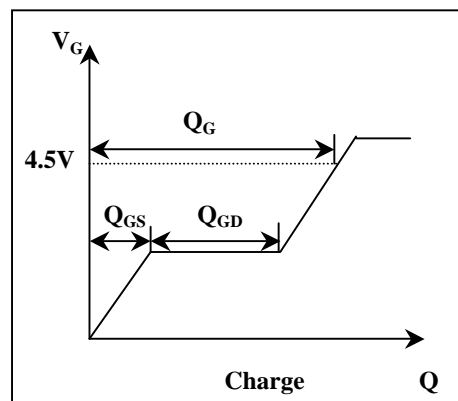

Fig 12. Gate Charge Waveform



AP3C020YT

P-Channel

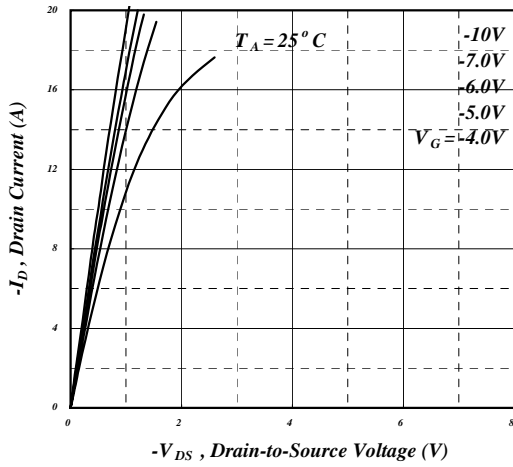

Fig 1. Typical Output Characteristics

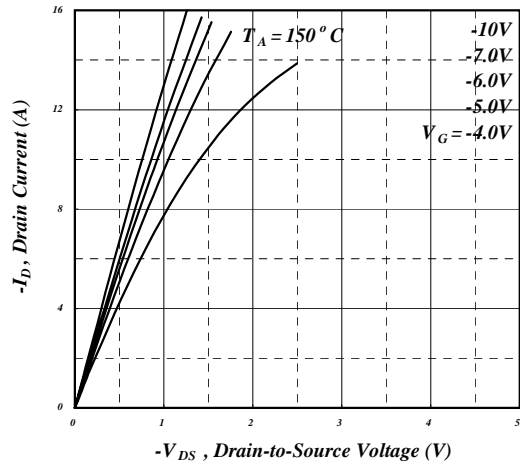

Fig 2. Typical Output Characteristics

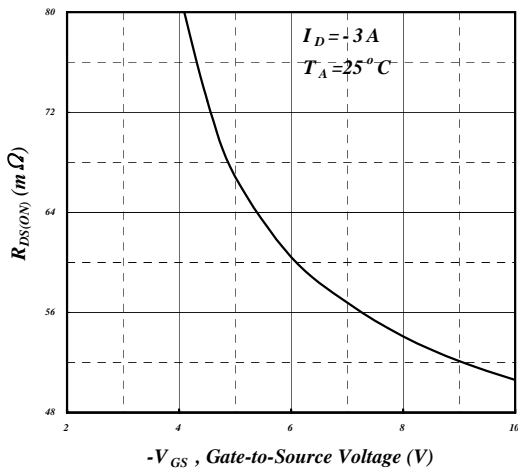

Fig 3. On-Resistance v.s. Gate Voltage

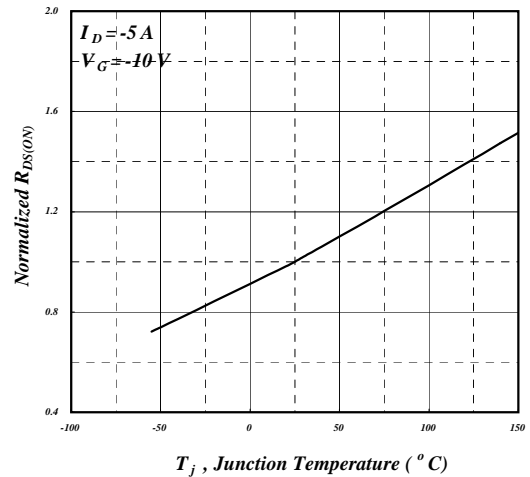

Fig 4. Normalized On-Resistance v.s. Junction Temperature

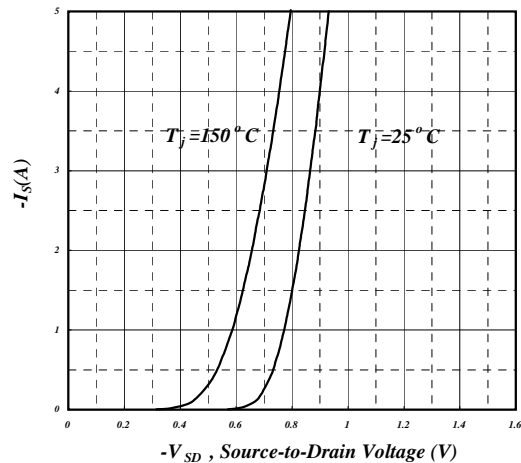

Fig 5. Forward Characteristic of Reverse Diode

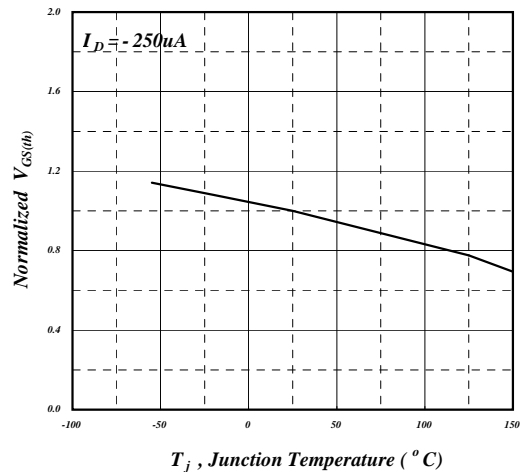

Fig 6. Gate Threshold Voltage v.s. Junction Temperature



P-Channel

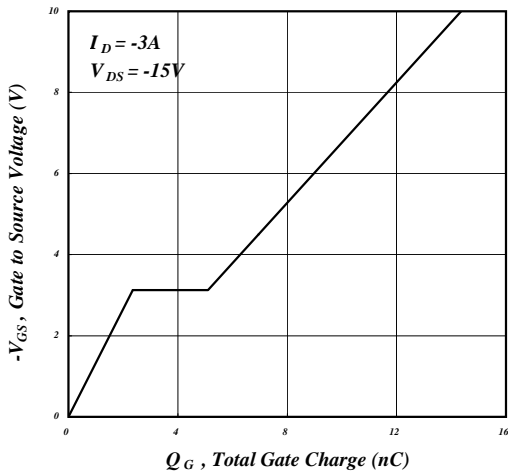

Fig 7. Gate Charge Characteristics

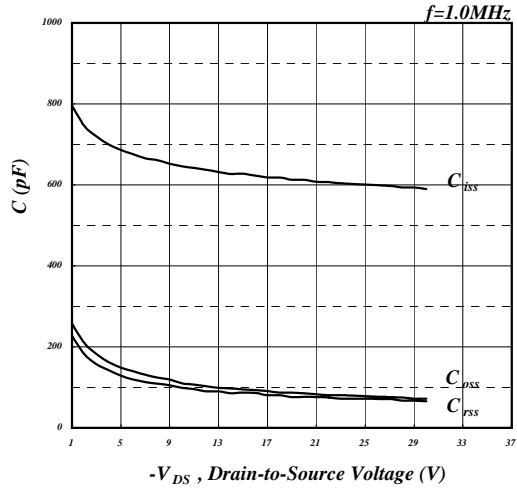

Fig 8. Typical Capacitance Characteristics

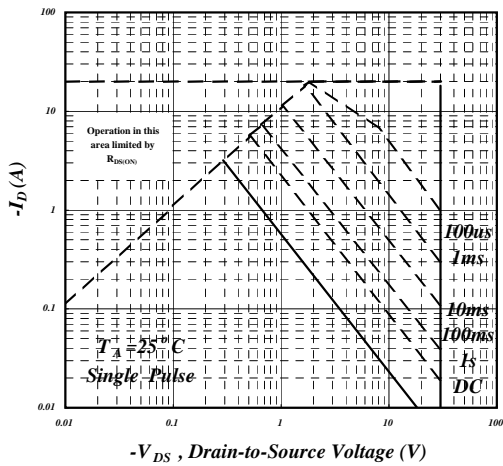

Fig 9. Maximum Safe Operating Area

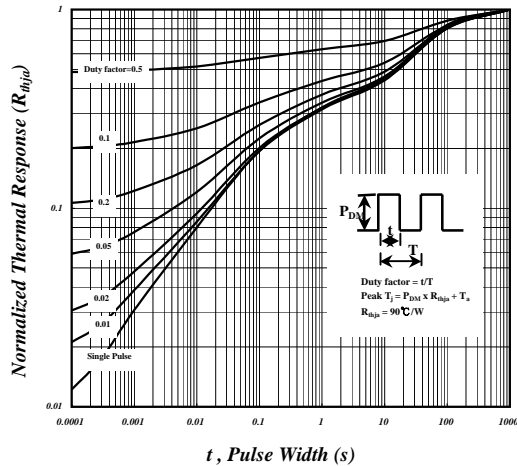

Fig 10. Effective Transient Thermal Impedance

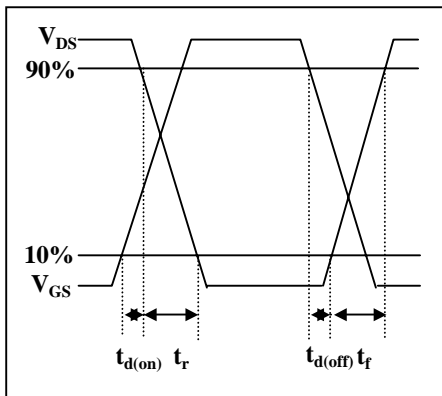

Fig 11. Switching Time Waveform

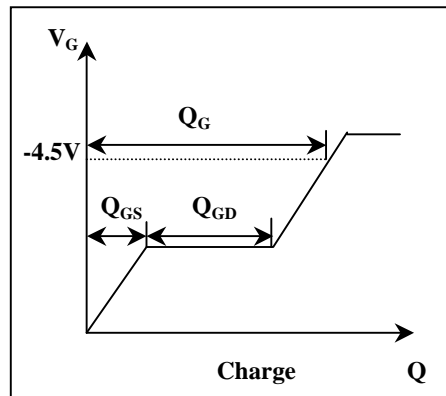
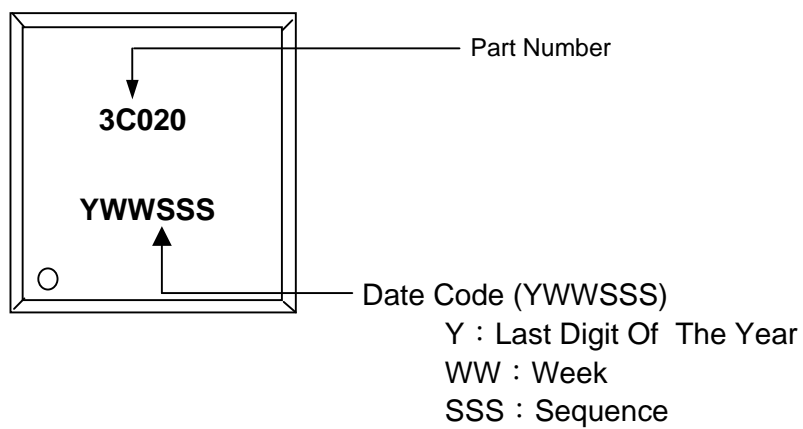

Fig 12. Gate Charge Waveform



AP3C020YT

MARKING INFORMATION





Package Outline : PMPAK 3x3 (Dual Pad)

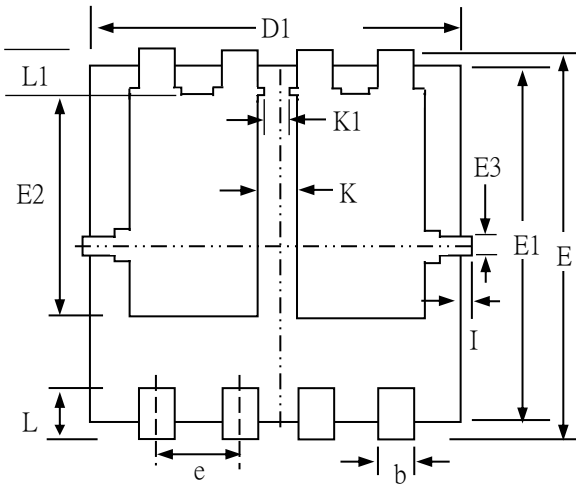

BACKSIDE VIEW

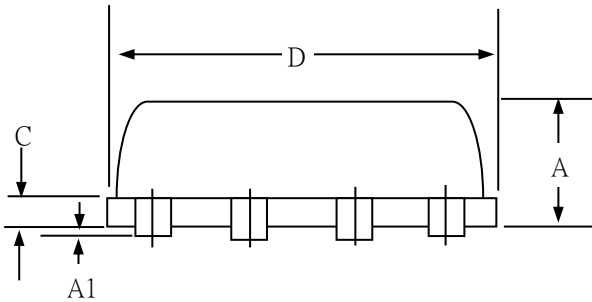

SYMBOLS	Millimeters		
	MIN	NOM	MAX
A	0.65	0.80	1.05
A1	-----	-----	0.15
b	0.20	0.35	0.50
C	0.10	0.15	0.25
D	2.85	3.30	3.60
D1	2.85	3.10	3.40
E	2.85	3.30	3.60
E1	2.85	3.10	3.40
E2	1.45	1.75	2.05
E3	0.10	0.20	0.30
e	0.65 (ref.)		
L	0.15	0.40	0.50
L1	0.15	0.50	0.70
K	0.20	0.38	0.65
K1	0.10	0.25	0.45
I	-----	-----	0.15

- 1.All Dimension Are In Millimeters.
- 2.Dimension Does Not Include Mold Protrusions.



PMPAK3X3(Dual Pad) FOOTPRINT :

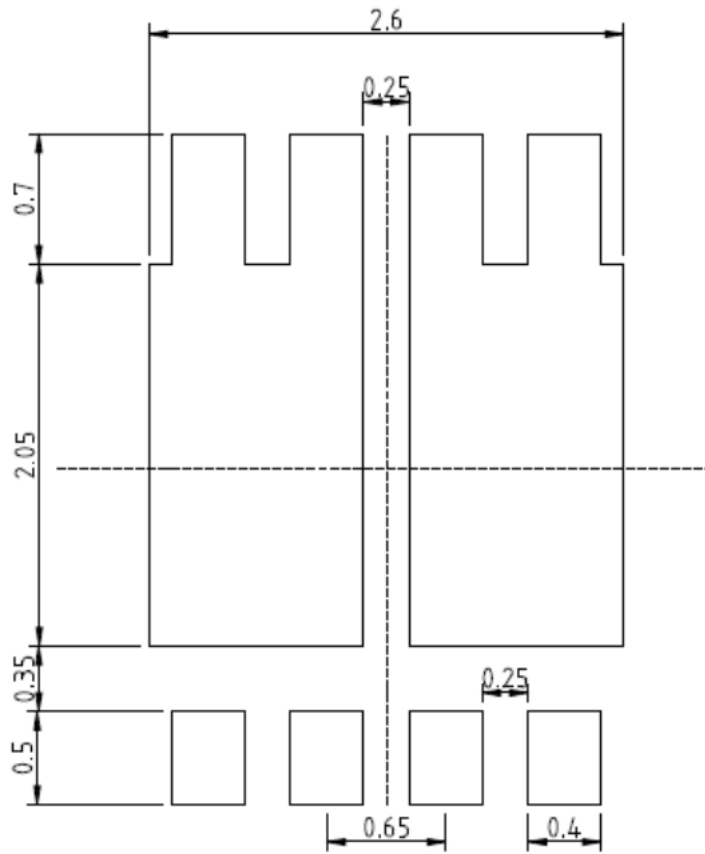

UNIT: mm