



**Advanced Power
Electronics Corp.**

AP3CA010MT

Halogen-Free Product

N AND P-CHANNEL ENHANCEMENT

MODE POWER MOSFET

- ▼ Simple Drive Requirement
- ▼ Low Gate Charge
- ▼ Fast Switching Performance
- ▼ RoHS Compliant & Halogen-Free

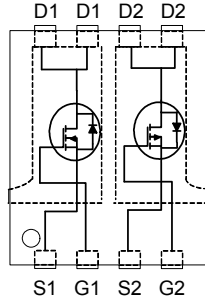

| | | |
|------|--------------|---------------|
| N-CH | BV_{DSS} | 30V |
| | $R_{DS(ON)}$ | 9.6m Ω |
| | I_D^3 | 15A |
| P-CH | BV_{DSS} | -30V |
| | $R_{DS(ON)}$ | 19m Ω |
| | I_D^3 | -11A |

Description

AP3CA010 series are from Advanced Power innovated design and silicon process technology to achieve the lowest possible on-resistance and fast switching performance. It provides the designer with an extreme efficient device for use in a wide range of power applications.

The PMPAK[®] 5x6 package is special for voltage conversion application using standard infrared reflow technique with the backside heat sink to achieve the good thermal performance.

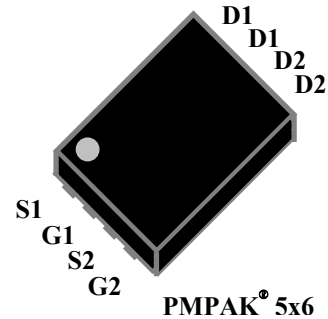

Absolute Maximum Ratings@T_j=25°C(unless otherwise specified)

| Symbol | Parameter | Rating | | Units |
|----------------------|--------------------------------------|------------|-----------|-------|
| | | N-channel | P-channel | |
| V_{DS} | Drain-Source Voltage | 30 | -30 | V |
| V_{GS} | Gate-Source Voltage | +20 | +20 | V |
| $I_D@T_A=25^\circ C$ | Drain Current, $V_{GS} @ 10V^3$ | 15 | -11 | A |
| $I_D@T_A=70^\circ C$ | Drain Current, $V_{GS} @ 10V^3$ | 12 | -9 | A |
| I_{DM} | Pulsed Drain Current ¹ | 40 | -30 | A |
| $P_D@T_A=25^\circ C$ | Total Power Dissipation | 3.57 | | W |
| T_{STG} | Storage Temperature Range | -55 to 150 | | °C |
| T_J | Operating Junction Temperature Range | -55 to 150 | | °C |

Thermal Data

| Symbol | Parameter | Rating | | Units |
|--------|---|-----------|-----------|-------|
| | | N-channel | P-channel | |
| Rthj-c | Maximum Thermal Resistance, Junction-case | 5 | 5 | °C/W |
| Rthj-a | Maximum Thermal Resistance, Junction-ambient ³ | 35 | 35 | °C/W |



AP3CA010MT

N-CH Electrical Characteristics@T_j=25°C(unless otherwise specified)

| Symbol | Parameter | Test Conditions | Min. | Typ. | Max. | Units |
|---------------------|--|--|------|------|------|-------|
| BV _{DSS} | Drain-Source Breakdown Voltage | V _{GS} =0V, I _D =250uA | 30 | - | - | V |
| R _{DS(ON)} | Static Drain-Source On-Resistance ² | V _{GS} =10V, I _D =9A | - | - | 9.6 | mΩ |
| | | V _{GS} =4.5V, I _D =5A | - | - | 14.5 | mΩ |
| V _{GS(th)} | Gate Threshold Voltage | V _{DS} =V _{GS} , I _D =250uA | 1.3 | - | 2.3 | V |
| g _{fs} | Forward Transconductance | V _{DS} =5V, I _D =9A | - | 35 | - | S |
| I _{DSS} | Drain-Source Leakage Current | V _{DS} =24V, V _{GS} =0V | - | - | 10 | uA |
| I _{GSS} | Gate-Source Leakage | V _{GS} =±20V, V _{DS} =0V | - | - | ±0.1 | uA |
| Q _g | Total Gate Charge | I _D =9A | - | 20 | 32 | nC |
| Q _{gs} | Gate-Source Charge | V _{DS} =15V | - | 4 | - | nC |
| Q _{gd} | Gate-Drain ("Miller") Charge | V _{GS} =10V | - | 4 | - | nC |
| t _{d(on)} | Turn-on Delay Time | V _{DS} =15V | - | 9 | - | ns |
| t _r | Rise Time | I _D =1A | - | 8 | - | ns |
| t _{d(off)} | Turn-off Delay Time | R _G =3.3Ω | - | 23 | - | ns |
| t _f | Fall Time | V _{GS} =10V | - | 6 | - | ns |
| C _{iss} | Input Capacitance | V _{GS} =0V | - | 1000 | 1600 | pF |
| C _{oss} | Output Capacitance | V _{DS} =25V | - | 120 | - | pF |
| C _{rss} | Reverse Transfer Capacitance | f=1.0MHz | - | 100 | - | pF |
| R _g | Gate Resistance | f=1.0MHz | - | 1.8 | 3.6 | Ω |

Source-Drain Diode

| Symbol | Parameter | Test Conditions | Min. | Typ. | Max. | Units |
|-----------------|---------------------------------|---|------|------|------|-------|
| V _{SD} | Forward On Voltage ² | I _S =2.9A, V _{GS} =0V | - | - | 1.2 | V |
| t _{rr} | Reverse Recovery Time | I _S =9A, V _{GS} =0V | - | 10 | - | ns |
| Q _{rr} | Reverse Recovery Charge | dI/dt=100A/μs | - | 3.5 | - | nC |

**P-CH Electrical Characteristics@T_j=25°C(unless otherwise specified)**

| Symbol | Parameter | Test Conditions | Min. | Typ. | Max. | Units |
|--------------|--|--------------------------------|------|------|-----------|-------|
| BV_{DSS} | Drain-Source Breakdown Voltage | $V_{GS}=0V, I_D=-250\mu A$ | -30 | - | - | V |
| $R_{DS(ON)}$ | Static Drain-Source On-Resistance ² | $V_{GS}=-10V, I_D=-7A$ | - | - | 19 | mΩ |
| | | $V_{GS}=-4.5V, I_D=-4A$ | - | - | 32 | mΩ |
| $V_{GS(th)}$ | Gate Threshold Voltage | $V_{DS}=V_{GS}, I_D=-250\mu A$ | -1.3 | - | -2.3 | V |
| g_{fs} | Forward Transconductance | $V_{DS}=-5V, I_D=-7A$ | - | 18 | - | S |
| I_{DSS} | Drain-Source Leakage Current | $V_{DS}=-24V, V_{GS}=0V$ | - | - | -10 | μA |
| I_{GSS} | Gate-Source Leakage | $V_{GS}=\pm 20V, V_{DS}=0V$ | - | - | ± 0.1 | μA |
| Q_g | Total Gate Charge | $I_D=-7A$ | - | 30 | 48 | nC |
| Q_{gs} | Gate-Source Charge | $V_{DS}=-15V$ | - | 6 | - | nC |
| Q_{gd} | Gate-Drain ("Miller") Charge | $V_{GS}=-10V$ | - | 5 | - | nC |
| $t_{d(on)}$ | Turn-on Delay Time | $V_{DS}=-15V$ | - | 12 | - | ns |
| t_r | Rise Time | $I_D=-1A$ | - | 10 | - | ns |
| $t_{d(off)}$ | Turn-off Delay Time | $R_G=3.3\Omega$ | - | 65 | - | ns |
| t_f | Fall Time | $V_{GS}=-10V$ | - | 33 | - | ns |
| C_{iss} | Input Capacitance | $V_{GS}=0V$ | - | 1680 | 2688 | pF |
| C_{oss} | Output Capacitance | $V_{DS}=-25V$ | - | 210 | - | pF |
| C_{rss} | Reverse Transfer Capacitance | $f=1.0MHz$ | - | 160 | - | pF |
| R_g | Gate Resistance | $f=1.0MHz$ | - | 11 | 22 | Ω |

Source-Drain Diode

| Symbol | Parameter | Test Conditions | Min. | Typ. | Max. | Units |
|----------|---------------------------------|------------------------|------|------|------|-------|
| V_{SD} | Forward On Voltage ² | $I_S=-2.9A, V_{GS}=0V$ | - | - | -1.2 | V |
| t_{rr} | Reverse Recovery Time | $I_S=-7A, V_{GS}=0V$ | - | 14 | - | ns |
| Q_{rr} | Reverse Recovery Charge | $di/dt=-100A/\mu s$ | - | 6 | - | nC |

Notes:

- 1.Pulse width limited by Max. junction temperature.
- 2.Pulse test
- 3.Surface mounted on 1 in² copper pad of FR4 board, $t \leq 10sec$; 85°C/W at steady state.

THIS PRODUCT IS SENSITIVE TO ELECTROSTATIC DISCHARGE, PLEASE HANDLE WITH CAUTION.

USE OF THIS PRODUCT AS A CRITICAL COMPONENT IN LIFE SUPPORT, AUTOMOTIVE OR OTHER SIMILAR SYSTEMS IS NOT AUTHORIZED. APEC DOES NOT ASSUME ANY LIABILITY ARISING OUT OF THE APPLICATION OR USE OF ANY PRODUCT OR CIRCUIT DESCRIBED HEREIN; NEITHER DOES IT CONVEY ANY LICENSE UNDER ITS PATENT RIGHTS, NOR THE RIGHTS OF OTHERS.

APEC RESERVES THE RIGHT TO MAKE CHANGES WITHOUT FURTHER NOTICE TO ANY PRODUCTS HEREIN TO IMPROVE RELIABILITY, FUNCTION OR DESIGN.



N-Channel

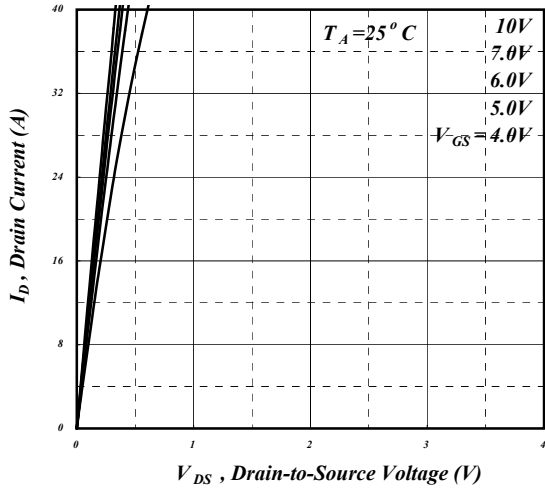

Fig 1. Typical Output Characteristics

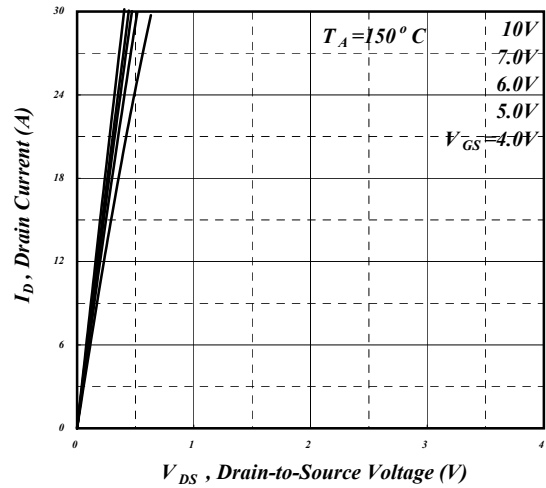

Fig 2. Typical Output Characteristics

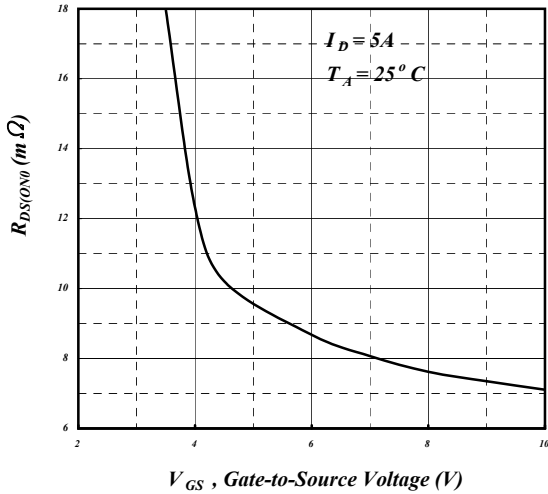

Fig 3. On-Resistance v.s. Gate Voltage

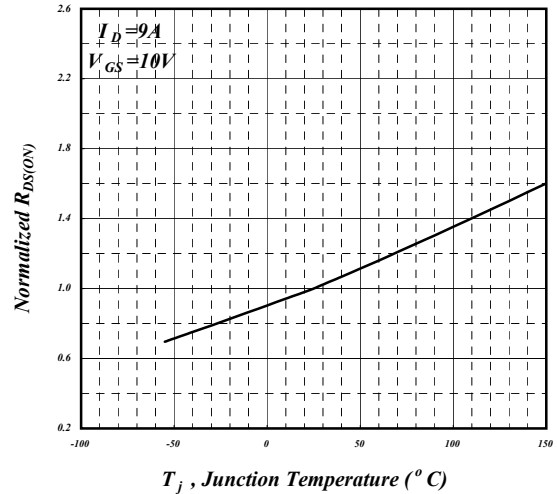

Fig 4. Normalized On-Resistance v.s. Junction Temperature

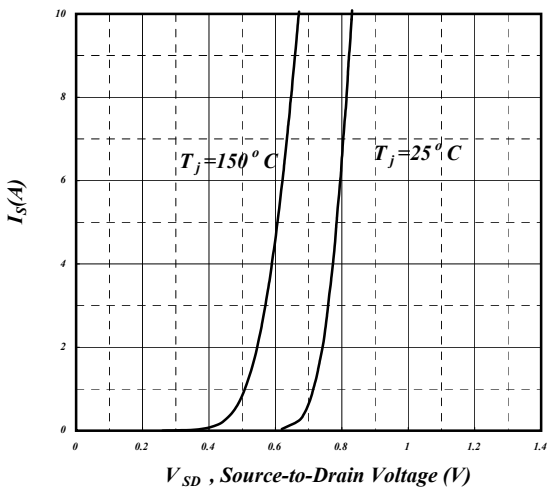

Fig 5. Forward Characteristic of Reverse Diode

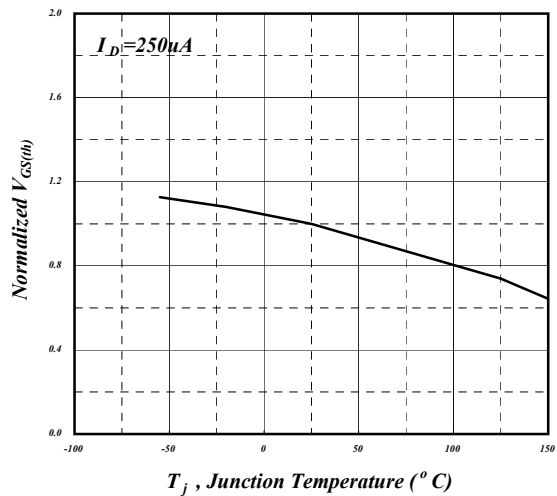

Fig 6. Gate Threshold Voltage v.s. Junction Temperature



N-Channel

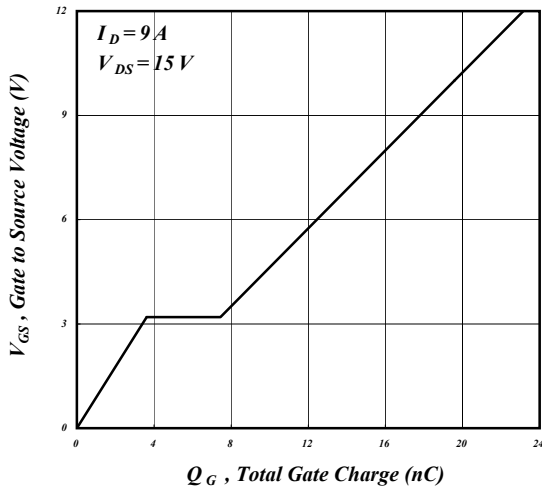

Fig 7. Gate Charge Characteristics

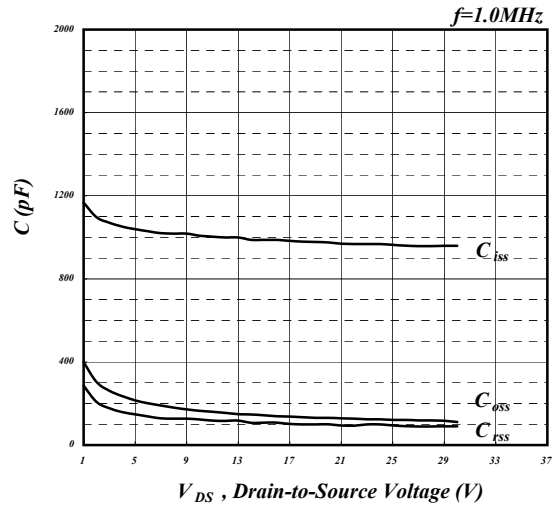

Fig 8. Typical Capacitance Characteristics

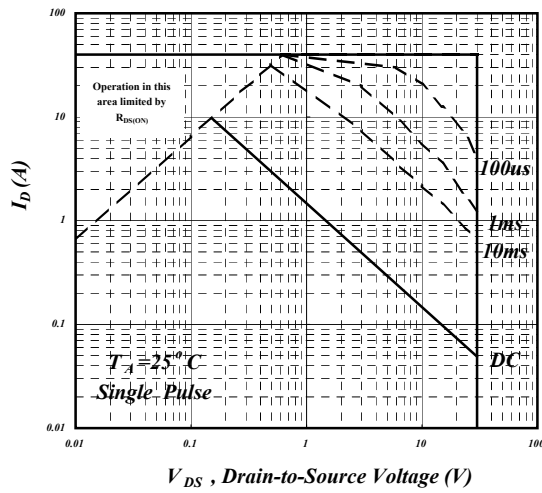

Fig 9. Maximum Safe Operating Area

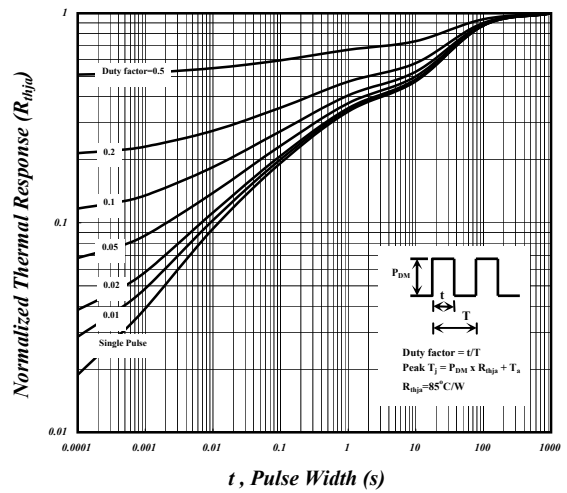

Fig 10. Effective Transient Thermal Impedance

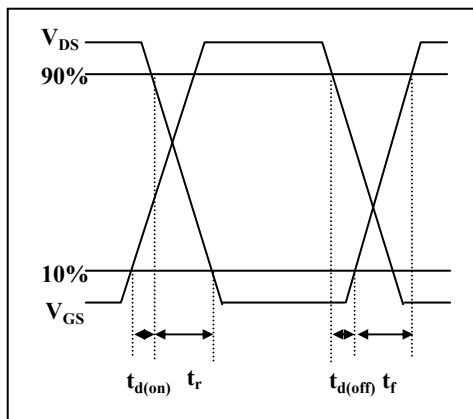

Fig 11. Switching Time Waveform

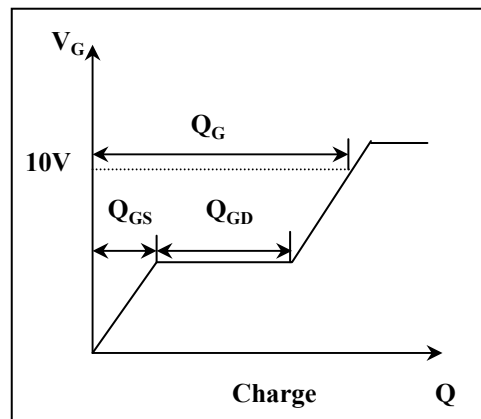

Fig 12. Gate Charge Waveform



AP3CA010MT

N-Channel

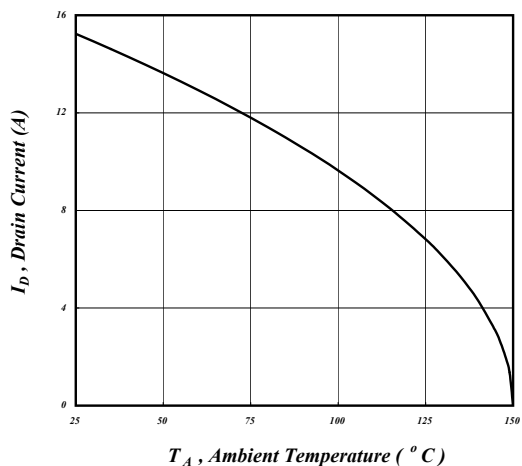

Fig 13. Drain Current v.s. Ambient Temperature

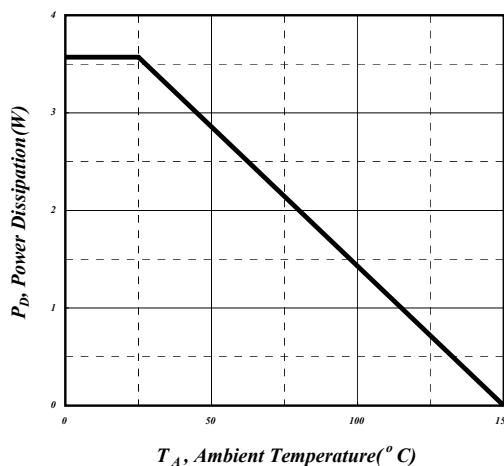

Fig 14. Total Power Dissipation

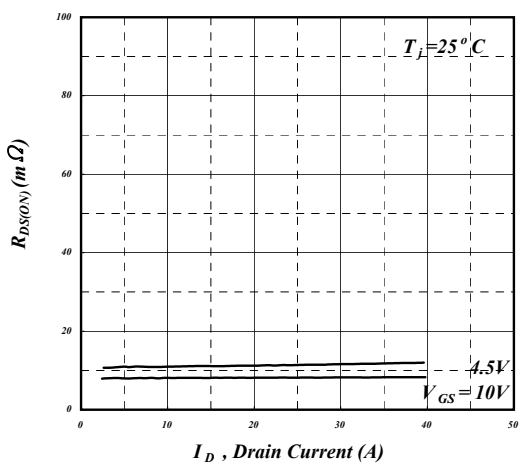

Fig 15. Typ. Drain-Source on State Resistance

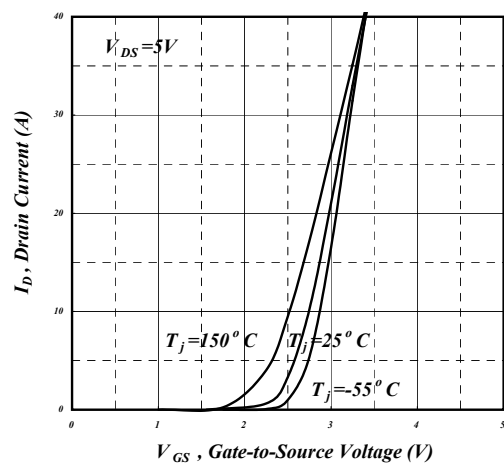

Fig 16. Transfer Characteristics



P-Channel

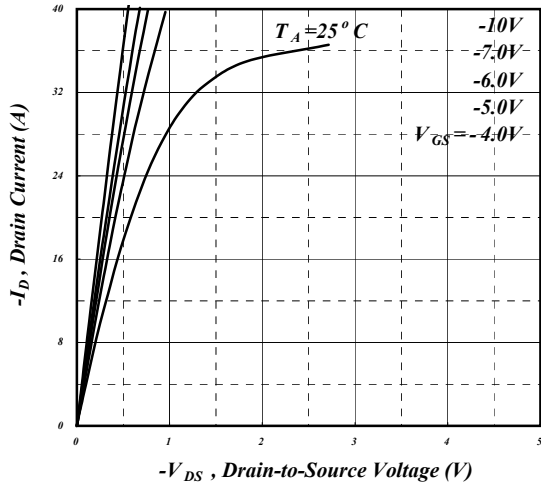

Fig 1. Typical Output Characteristics

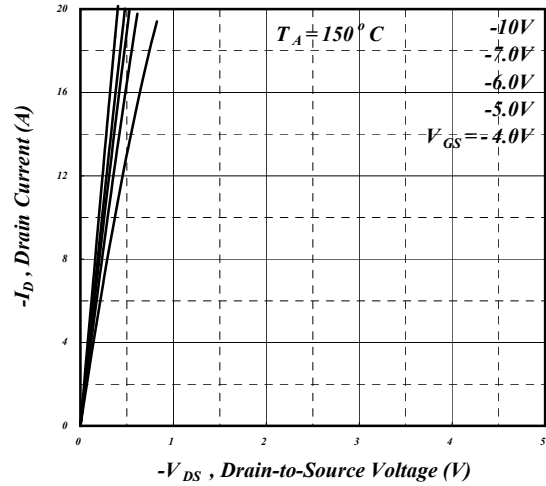

Fig 2. Typical Output Characteristics

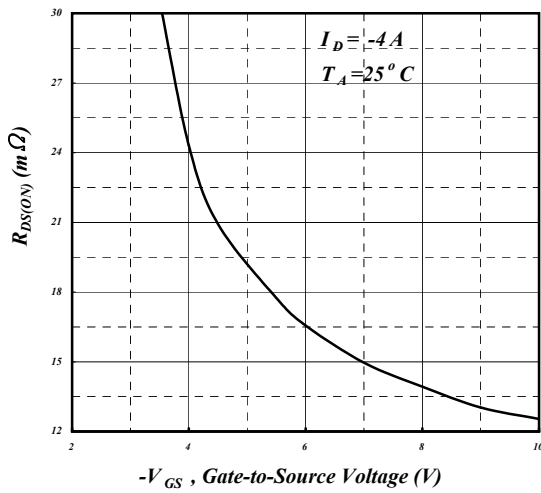

Fig 3. On-Resistance v.s. Gate Voltage

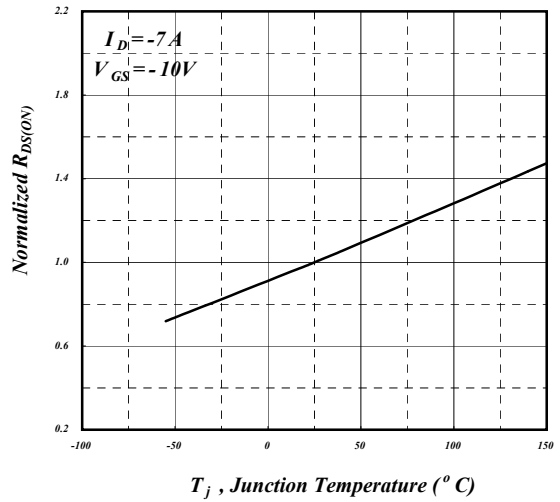

Fig 4. Normalized On-Resistance v.s. Junction Temperature

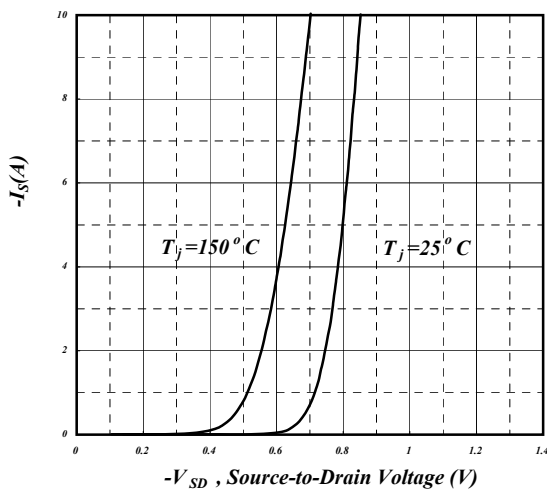

Fig 5. Forward Characteristic of Reverse Diode

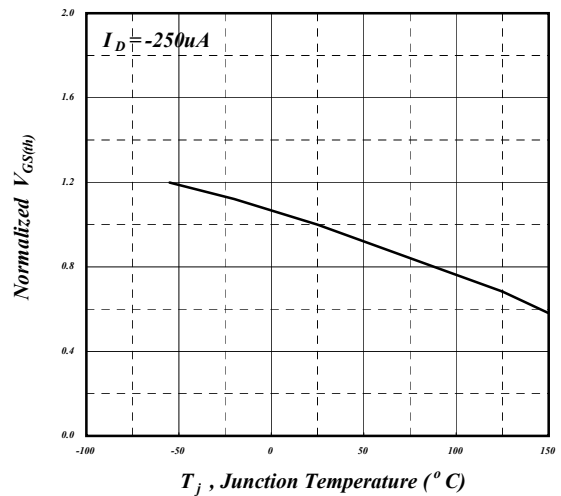

Fig 6. Gate Threshold Voltage v.s. Junction Temperature



AP3CA010MT

P-Channel

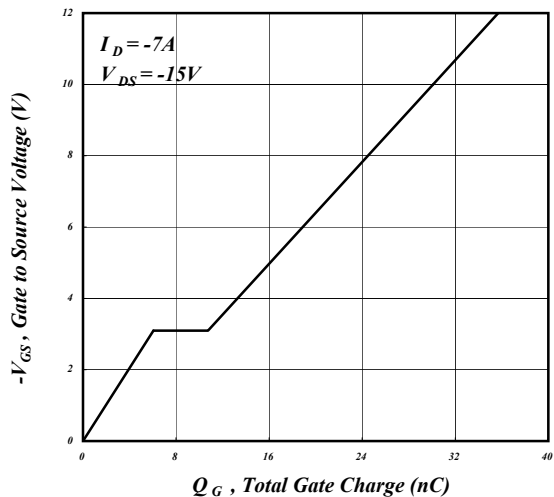

Fig 7. Gate Charge Characteristics

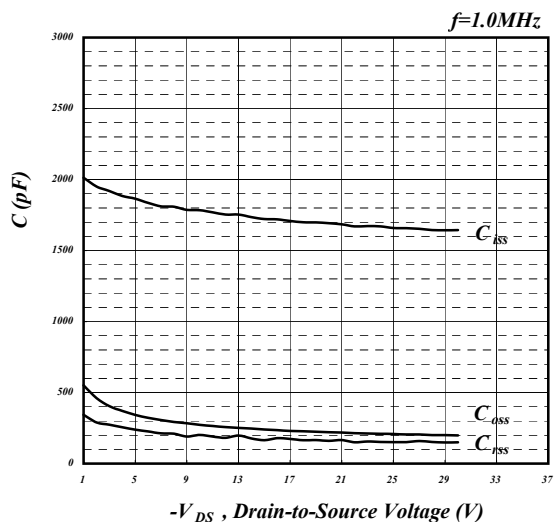

Fig 8. Typical Capacitance Characteristics

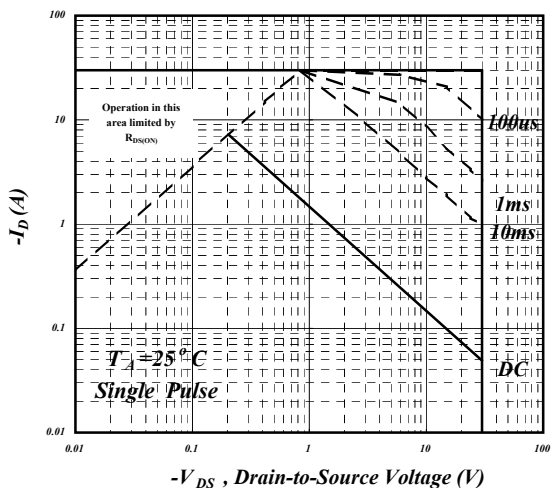

Fig 9. Maximum Safe Operating Area

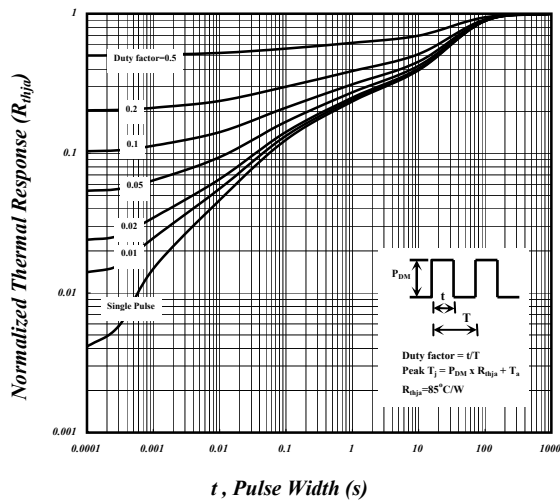

Fig 10. Effective Transient Thermal Impedance

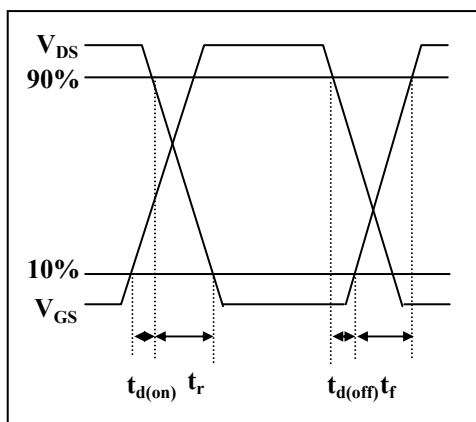

Fig 11. Switching Time Waveform

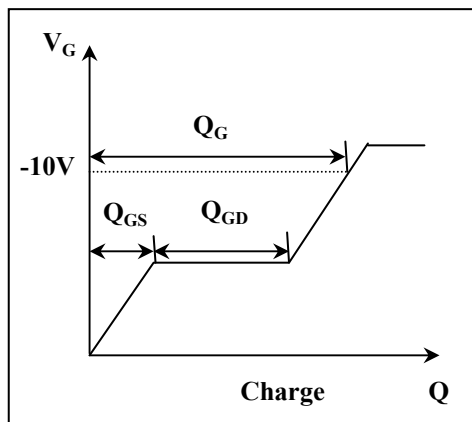

Fig 12. Gate Charge Waveform



P-Channel

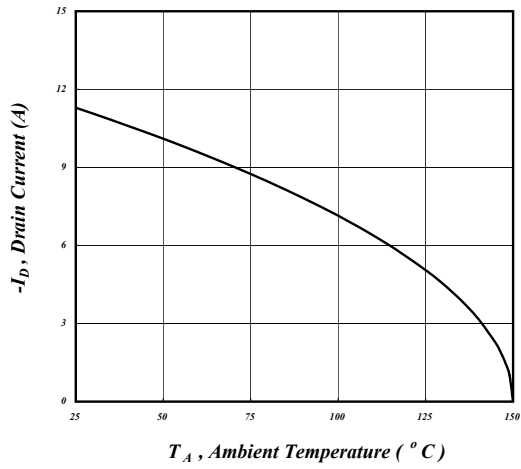

Fig 13. Drain Current v.s. Ambient Temperature

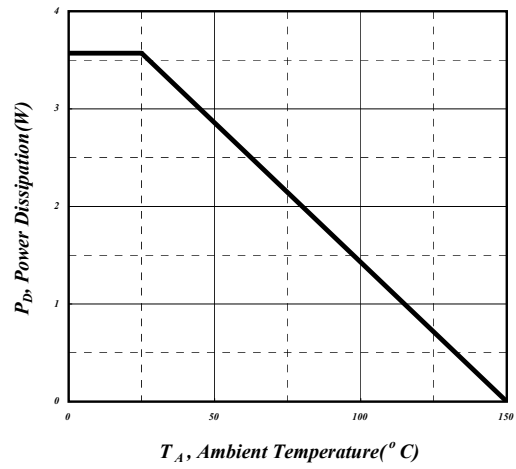

Fig 14. Total Power Dissipation

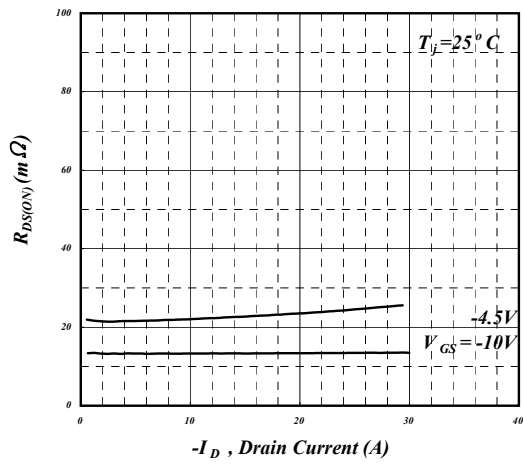

Fig 15. Typ. Drain-Source on State Resistance

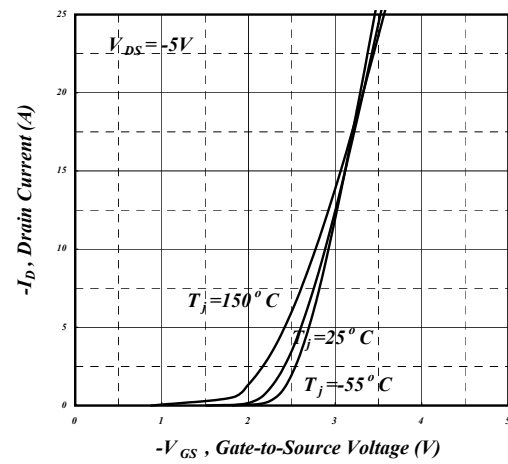
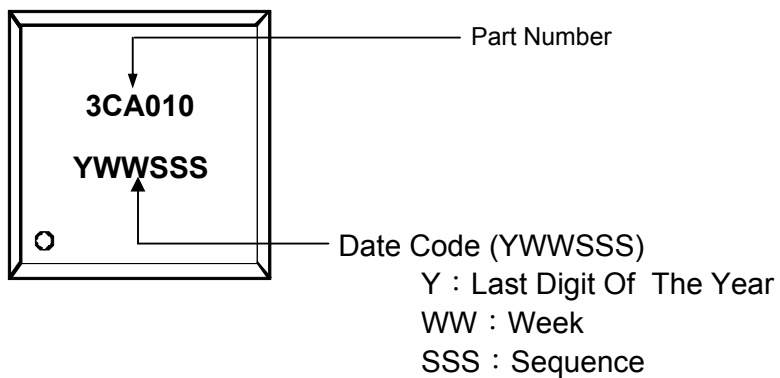

Fig 16. Transfer Characteristics



AP3CA010MT

MARKING INFORMATION



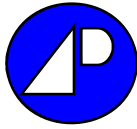

Package Outline : PMPAK 5x6 (Dual Pad)

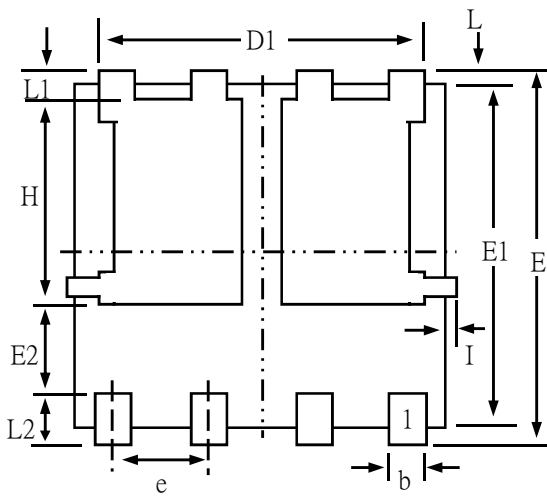

BACKSIDE VIEW

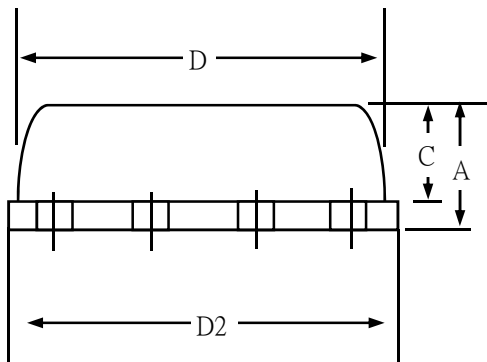

| SYMBOLS | Millimeters | | |
|---------|-------------|------|------|
| | MIN | NOM | MAX |
| A | 0.80 | 1.00 | 1.20 |
| b | 0.34 | 0.42 | 0.50 |
| C | 0.54 | 0.76 | 0.97 |
| D | 4.80 | 4.95 | 5.10 |
| D1 | 4.11 | 4.21 | 4.31 |
| E | 5.90 | 6.05 | 6.20 |
| E1 | 5.60 | 5.75 | 5.90 |
| E2 | 1.60 (ref.) | | |
| e | 1.27 (ref.) | | |
| L | 0.05 | 0.15 | 0.25 |
| L1 | 0.60 (ref.) | | |
| L2 | 0.60 (ref.) | | |
| H | 3.60 (ref.) | | |
| I | 0.15 (ref.) | | |
| D2 | 4.80 | 5.15 | 5.50 |

1.All Dimension Are In Millimeters.

2.Dimension Does Not Include Mold Protrusions.



PMPAK5X6(Dual Pad,左右) FOOTPRINT :

