

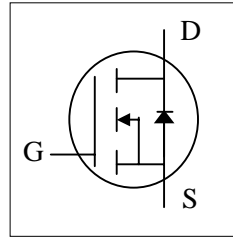

- ▼ Simple Drive Requirement
- ▼ SO-8 Compatible with Heatsink
- ▼ Low On-resistance
- ▼ RoHS Compliant & Halogen-Free



$BV_{DSS}$	30V
$R_{DS(ON)}$	3.3m $\Omega$
$I_D^5$	105A

## Description

AP3R303 series are from Advanced Power innovated design and silicon process technology to achieve the lowest possible on-resistance and fast switching performance. It provides the designer with an extreme efficient device for use in a wide range of power applications.

The PMPAK<sup>®</sup> 5x6L ppackage is special for voltage conversion application using standard infrared reflow technique with the backside heat sink to achieve the good thermal performance.

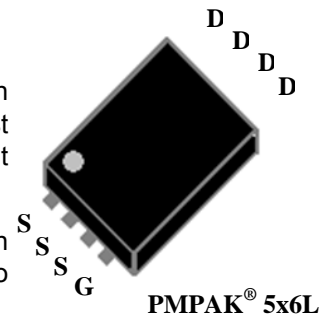

## Absolute Maximum Ratings @ $T_j=25^\circ\text{C}$ (unless otherwise specified)

Symbol	Parameter	Rating	Units
$V_{DS}$	Drain-Source Voltage	30	V
$V_{GS}$	Gate-Source Voltage	+20	V
$I_D@T_C=25^\circ\text{C}$	Drain Current (Chip), $V_{GS} @ 10V^5$	105	A
$I_D@T_A=25^\circ\text{C}$	Drain Current <sup>3</sup> , $V_{GS} @ 10V$	31	A
$I_D@T_A=70^\circ\text{C}$	Drain Current <sup>3</sup> , $V_{GS} @ 10V$	25	A
$I_{DM}$	Pulsed Drain Current <sup>1</sup>	250	A
$P_D@T_C=25^\circ\text{C}$	Total Power Dissipation	56.8	W
$P_D@T_A=25^\circ\text{C}$	Total Power Dissipation	5	W
$E_{AS}$	Single Pulse Avalanche Energy <sup>4</sup>	28.8	mJ
$T_{STG}$	Storage Temperature Range	-55 to 150	$^\circ\text{C}$
$T_J$	Operating Junction Temperature Range	-55 to 150	$^\circ\text{C}$

## Thermal Data

Symbol	Parameter	Value	Units
Rthj-c	Maximum Thermal Resistance, Junction-case	2.2	$^\circ\text{C}/\text{W}$
Rthj-a	Maximum Thermal Resistance, Junction-ambient <sup>3</sup>	25	$^\circ\text{C}/\text{W}$



# AP3R303GMT-L

## Electrical Characteristics @ $T_j=25^{\circ}\text{C}$ (unless otherwise specified)

Symbol	Parameter	Test Conditions	Min.	Typ.	Max.	Units
$BV_{DSS}$	Drain-Source Breakdown Voltage	$V_{GS}=0V, I_D=250\mu A$	30	-	-	V
$R_{DS(ON)}$	Static Drain-Source On-Resistance <sup>2</sup>	$V_{GS}=10V, I_D=30A$	-	-	3.3	m $\Omega$
		$V_{GS}=4.5V, I_D=20A$	-	-	4.5	m $\Omega$
$V_{GS(th)}$	Gate Threshold Voltage	$V_{DS}=V_{GS}, I_D=250\mu A$	1	-	3	V
$g_{fs}$	Forward Transconductance	$V_{DS}=10V, I_D=20A$	-	60	-	S
$I_{DSS}$	Drain-Source Leakage Current	$V_{DS}=24V, V_{GS}=0V$	-	-	10	$\mu A$
$I_{GSS}$	Gate-Source Leakage	$V_{GS}=\pm 20V, V_{DS}=0V$	-	-	$\pm 100$	nA
$Q_g$	Total Gate Charge	$I_D=30A$	-	13.3	21	nC
$Q_{gs}$	Gate-Source Charge	$V_{DS}=15V$	-	2.5		nC
$Q_{gd}$	Gate-Drain ("Miller") Charge	$V_{GS}=4.5V$	-	7.2		nC
$t_{d(on)}$	Turn-on Delay Time	$V_{DS}=15V$	-	8	-	ns
$t_r$	Rise Time	$I_D=1A$	-	5.5	-	ns
$t_{d(off)}$	Turn-off Delay Time	$R_G=3.3\Omega$	-	25	-	ns
$t_f$	Fall Time	$V_{GS}=10V$	-	17	-	ns
$C_{iss}$	Input Capacitance	$V_{GS}=0V$	-	1400	2240	pF
$C_{oss}$	Output Capacitance	$V_{DS}=25V$	-	440	-	pF
$C_{riss}$	Reverse Transfer Capacitance	$f=1.0\text{MHz}$	-	170	-	pF
$R_g$	Gate Resistance	$f=1.0\text{MHz}$	-	1.4	2.8	$\Omega$

## Source-Drain Diode

Symbol	Parameter	Test Conditions	Min.	Typ.	Max.	Units
$V_{SD}$	Forward On Voltage <sup>2</sup>	$I_S=30A, V_{GS}=0V$	-	-	1.2	V
$t_{rr}$	Reverse Recovery Time	$I_S=10A, V_{GS}=0V,$	-	35	-	ns
$Q_{rr}$	Reverse Recovery Charge	$dI/dt=100A/\mu s$	-	32	-	nC

### Notes:

1. Pulse width limited by Max. junction temperature
2. Pulse test
3. Surface mounted on 1 in<sup>2</sup> copper pad of FR4 board,  $t \leq 10\text{sec}$ ;  $60^{\circ}\text{C/W}$  at steady state.
4. Starting  $T_j=25^{\circ}\text{C}$ ,  $V_{DD}=25V$ ,  $L=0.1\text{mH}$ ,  $R_G=25\Omega$ ,  $I_{AS}=24A$ .
5. Package limitation current is 60A.

THIS PRODUCT IS SENSITIVE TO ELECTROSTATIC DISCHARGE, PLEASE HANDLE WITH CAUTION.

USE OF THIS PRODUCT AS A CRITICAL COMPONENT IN LIFE SUPPORT OR OTHER SIMILAR SYSTEMS IS NOT AUTHORIZED.

APEC DOES NOT ASSUME ANY LIABILITY ARISING OUT OF THE APPLICATION OR USE OF ANY PRODUCT OR CIRCUIT DESCRIBED HEREIN; NEITHER DOES IT CONVEY ANY LICENSE UNDER ITS PATENT RIGHTS, NOR THE RIGHTS OF OTHERS.

APEC RESERVES THE RIGHT TO MAKE CHANGES WITHOUT FURTHER NOTICE TO ANY PRODUCTS HEREIN TO IMPROVE RELIABILITY, FUNCTION OR DESIGN.

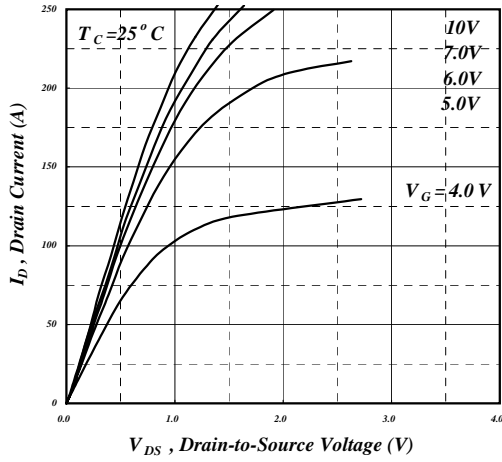

Fig 1. Typical Output Characteristics

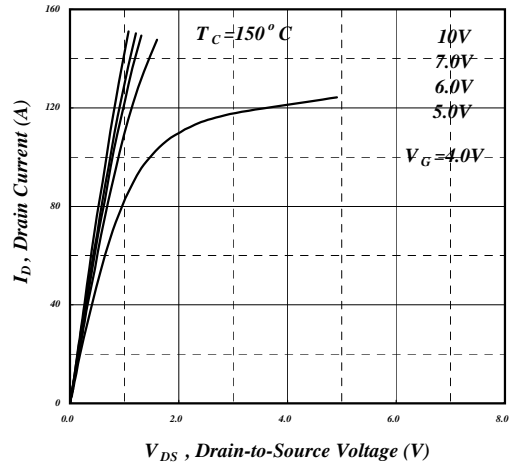

Fig 2. Typical Output Characteristics

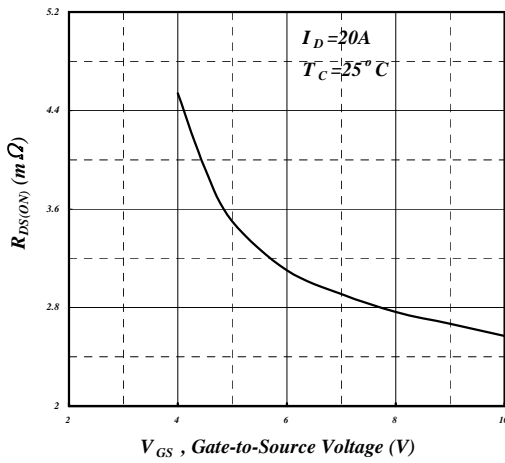

Fig 3. On-Resistance v.s. Gate Voltage

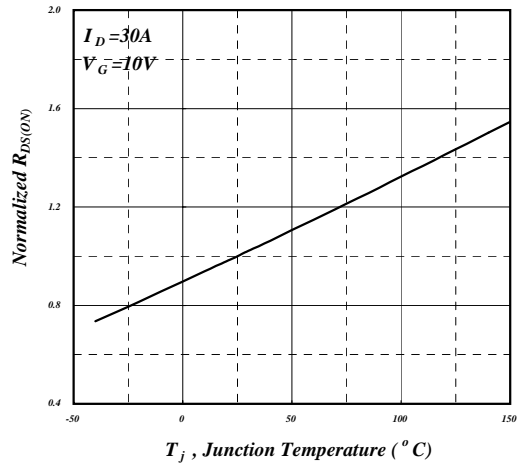

Fig 4. Normalized On-Resistance v.s. Junction Temperature

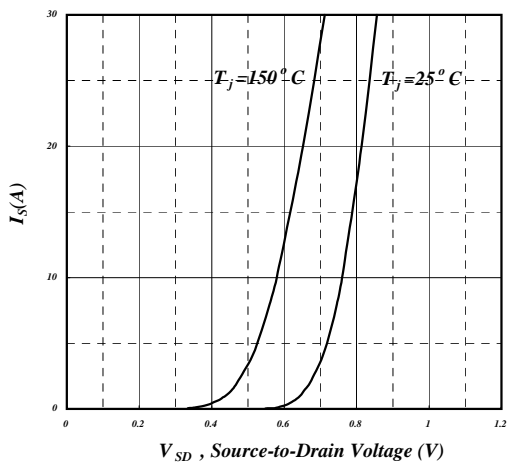

Fig 5. Forward Characteristic of Reverse Diode

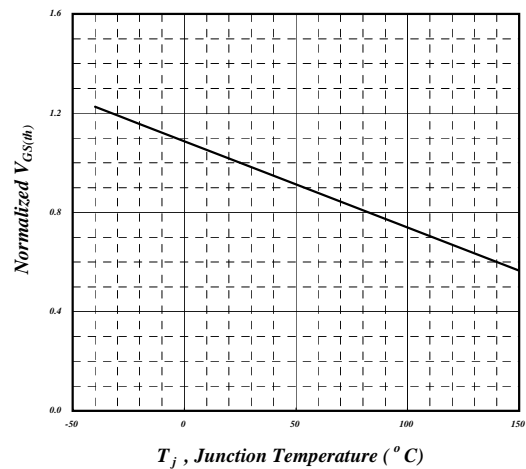

Fig 6. Gate Threshold Voltage v.s. Junction Temperature

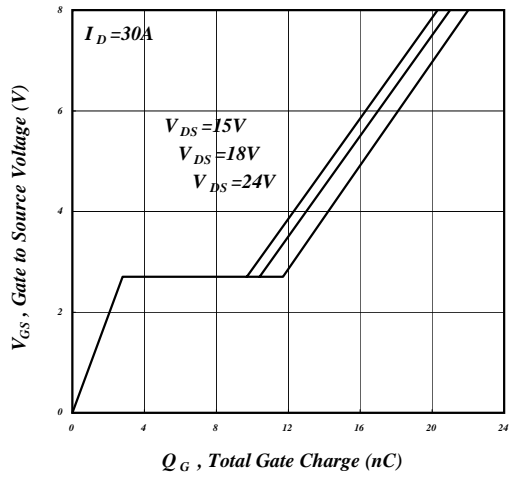

Fig 7. Gate Charge Characteristics

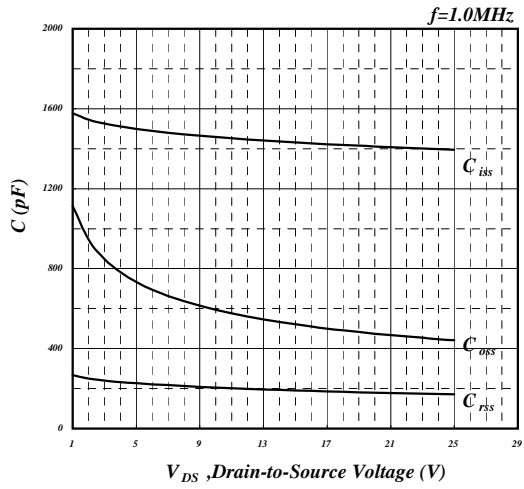

Fig 8. Typical Capacitance Characteristics

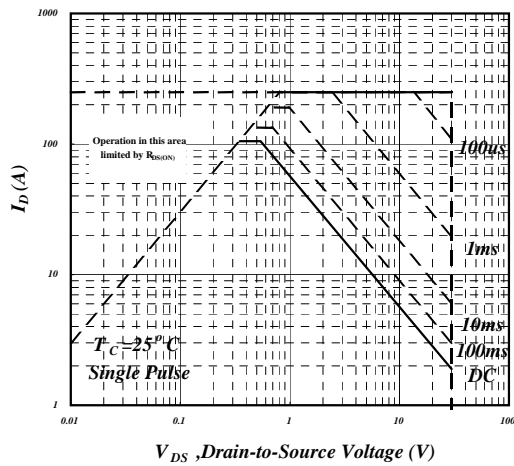

Fig 9. Maximum Safe Operating Area

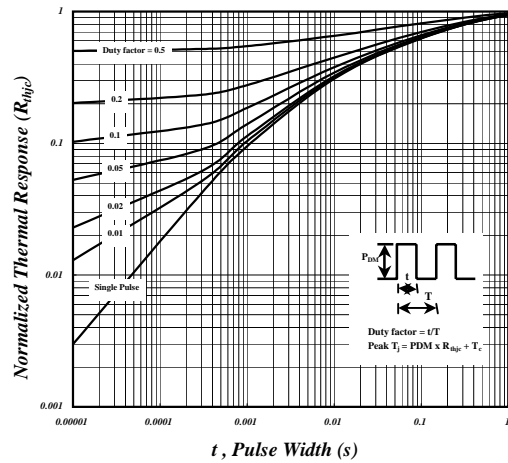

Fig 10. Effective Transient Thermal Impedance

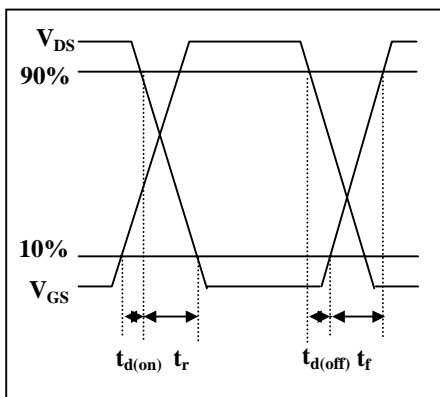

Fig 11. Switching Time Waveform

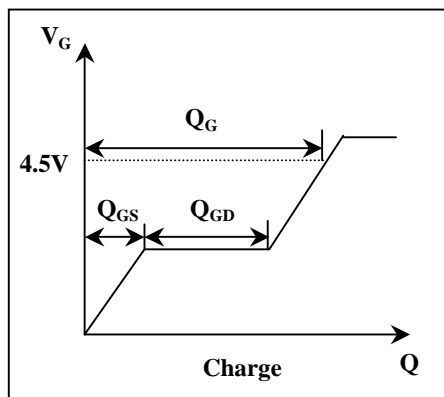
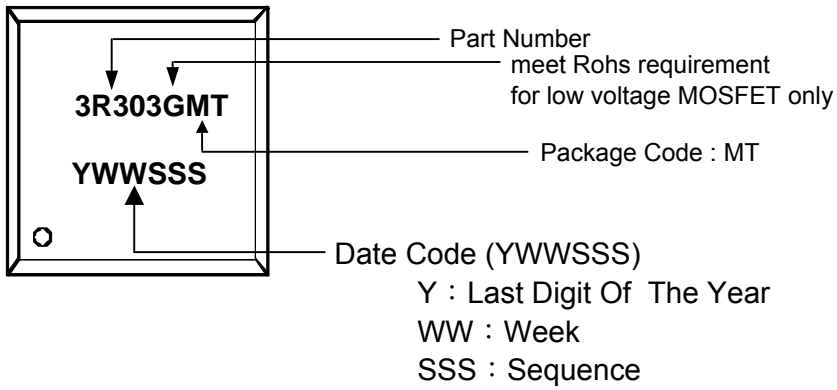

Fig 12. Gate Charge Waveform



**MARKING INFORMATION**





## Package Outline : PMPAK 5x6L

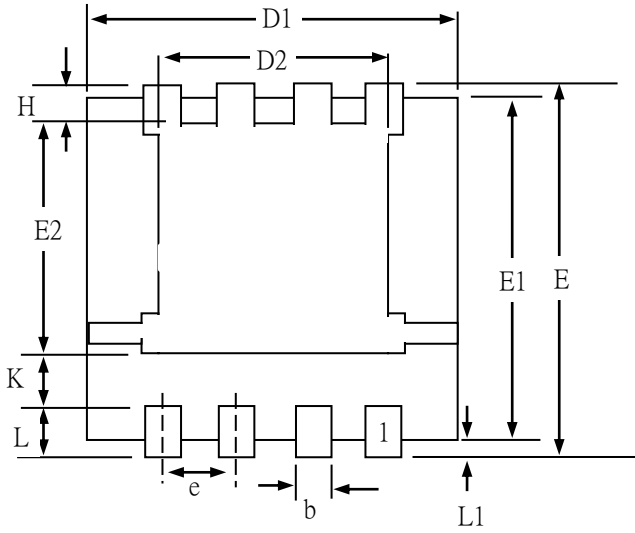

BACKSIDE VIEW

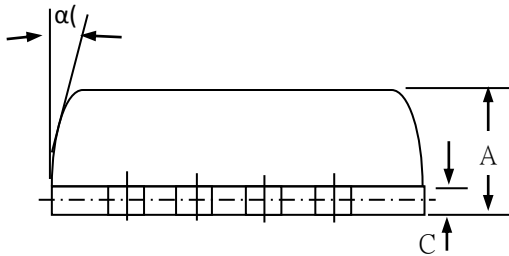

SYMBOLS	Millimeters		
	MIN	NOM	MAX
A	0.90	1.10	1.30
b	0.33	0.41	0.51
C	0.15	—	—
D1	4.80	4.90	5.10
D2	—	—	4.40
E	6.25	6.35	6.45
E1 (Ref.)	5.60	5.75	5.90
E2 (Ref.)	3.30	3.55	3.80
e	1.27 BSC		
H	—	—	0.90
K (Ref.)	0.70	—	—
L	0.68	0.78	0.88
L1	0.25	0.30	0.40
alpha(Ref.)	0°	—	12°

- 1.All Dimension Are In Millimeters.
- 2.Dimension Does Not Include Mold Protrusions.



PMPAK 5X6L FOOTPRINT :

