

# AP4024GEMT-HF

**Halogen-Free Product**



**Advanced Power  
Electronics Corp.**

N-CHANNEL ENHANCEMENT MODE

POWER MOSFET

- ▼ Simple Drive Requirement
- ▼ SO-8 Compatible with Heatsink
- ▼ Low On-resistance
- ▼ RoHS Compliant & Halogen-Free

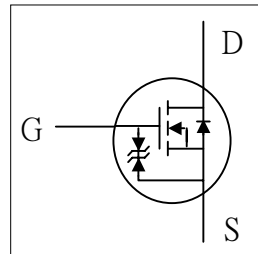

$BV_{DSS}$	30V
$R_{DS(ON)}$	4.5m $\Omega$
$I_D^4$	60A

## Description

AP4024 series are from Advanced Power innovated design and silicon process technology to achieve the lowest possible on-resistance and fast switching performance. It provides the designer with an extreme efficient device for use in a wide range of power applications.

The PMPAK<sup>®</sup> 5x6 package is special for DC-DC converters application and the foot print is compatible with SO-8 with backside heat sink and lower profile.

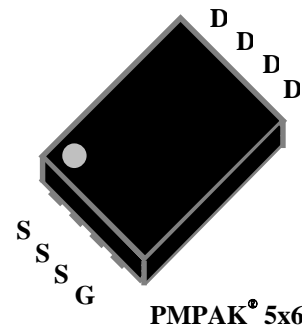

## Absolute Maximum Ratings @ $T_J=25^\circ\text{C}$ (unless otherwise specified)

Symbol	Parameter	Rating	Units
$V_{DS}$	Drain-Source Voltage	30	V
$V_{GS}$	Gate-Source Voltage	$\pm 20$	V
$I_D @ T_C=25^\circ\text{C}$	Drain Current (Chip), $V_{GS} @ 10V^4$	60	A
$I_D @ T_A=25^\circ\text{C}$	Drain Current, $V_{GS} @ 10V^3$	26.1	A
$I_D @ T_A=70^\circ\text{C}$	Drain Current, $V_{GS} @ 10V^3$	20.9	A
$I_{DM}$	Pulsed Drain Current <sup>1</sup>	160	A
$P_D @ T_C=25^\circ\text{C}$	Total Power Dissipation	36.7	W
$P_D @ T_A=25^\circ\text{C}$	Total Power Dissipation <sup>3</sup>	5	W
$T_{STG}$	Storage Temperature Range	-55 to 150	$^\circ\text{C}$
$T_J$	Operating Junction Temperature Range	-55 to 150	$^\circ\text{C}$

## Thermal Data

Symbol	Parameter	Value	Unit
Rthj-c	Maximum Thermal Resistance, Junction-case	3.4	$^\circ\text{C}/\text{W}$
Rthj-a	Maximum Thermal Resistance, Junction-ambient <sup>3</sup>	25	$^\circ\text{C}/\text{W}$



# AP4024GEMT-HF

## Electrical Characteristics @T<sub>j</sub>=25°C(unless otherwise specified)

Symbol	Parameter	Test Conditions	Min.	Typ.	Max.	Units
BV <sub>DSS</sub>	Drain-Source Breakdown Voltage	V <sub>GS</sub> =0V, I <sub>D</sub> =250uA	30	-	-	V
R <sub>DS(ON)</sub>	Static Drain-Source On-Resistance <sup>2</sup>	V <sub>GS</sub> =10V, I <sub>D</sub> =20A	-	3.5	4.5	mΩ
		V <sub>GS</sub> =4.5V, I <sub>D</sub> =20A	-	5	8.5	mΩ
V <sub>GS(th)</sub>	Gate Threshold Voltage	V <sub>DS</sub> =V <sub>GS</sub> , I <sub>D</sub> =250uA	1.2	1.6	2.5	V
g <sub>fs</sub>	Forward Transconductance	V <sub>DS</sub> =10V, I <sub>D</sub> =20A	-	70	-	S
I <sub>DSS</sub>	Drain-Source Leakage Current	V <sub>DS</sub> =24V, V <sub>GS</sub> =0V	-	-	10	uA
I <sub>GSS</sub>	Gate-Source Leakage	V <sub>GS</sub> =±20V, V <sub>DS</sub> =0V	-	-	±30	uA
Q <sub>g</sub>	Total Gate Charge	I <sub>D</sub> =20A	-	15	24	nC
Q <sub>gs</sub>	Gate-Source Charge	V <sub>DS</sub> =15V	-	4	-	nC
Q <sub>gd</sub>	Gate-Drain ("Miller") Charge	V <sub>GS</sub> =4.5V	-	8	-	nC
t <sub>d(on)</sub>	Turn-on Delay Time	V <sub>DS</sub> =15V	-	14	-	ns
t <sub>r</sub>	Rise Time	I <sub>D</sub> =1A	-	10	-	ns
t <sub>d(off)</sub>	Turn-off Delay Time	R <sub>G</sub> =6Ω	-	33	-	ns
t <sub>f</sub>	Fall Time	V <sub>GS</sub> =10V	-	18	-	ns
C <sub>iss</sub>	Input Capacitance	V <sub>GS</sub> =0V	-	1500	2400	pF
C <sub>oss</sub>	Output Capacitance	V <sub>DS</sub> =15V	-	320	-	pF
C <sub>rss</sub>	Reverse Transfer Capacitance	f=1.0MHz	-	210	-	pF
R <sub>g</sub>	Gate Resistance	f=1.0MHz	-	1.2	2.4	Ω

## Source-Drain Diode

Symbol	Parameter	Test Conditions	Min.	Typ.	Max.	Units
V <sub>SD</sub>	Forward On Voltage <sup>2</sup>	I <sub>S</sub> =20A, V <sub>GS</sub> =0V	-	-	1.2	V
t <sub>rr</sub>	Reverse Recovery Time	I <sub>S</sub> =20A, V <sub>GS</sub> =0V,	-	20	-	ns
Q <sub>rr</sub>	Reverse Recovery Charge	dI/dt=100A/μs	-	5	-	nC

### Notes:

- 1.Pulse width limited by Max. junction temperature.
- 2.Pulse test
- 3.Surface mounted on 1 in<sup>2</sup> copper pad of FR4 board, t ≤10sec; 60°C/W at steady state.
- 4.Package limitation current is 60A .

THIS PRODUCT IS SENSITIVE TO ELECTROSTATIC DISCHARGE, PLEASE HANDLE WITH CAUTION.

USE OF THIS PRODUCT AS A CRITICAL COMPONENT IN LIFE SUPPORT OR OTHER SIMILAR SYSTEMS IS NOT AUTHORIZED.

APEC DOES NOT ASSUME ANY LIABILITY ARISING OUT OF THE APPLICATION OR USE OF ANY PRODUCT OR CIRCUIT DESCRIBED HEREIN; NEITHER DOES IT CONVEY ANY LICENSE UNDER ITS PATENT RIGHTS, NOR THE RIGHTS OF OTHERS.

APEC RESERVES THE RIGHT TO MAKE CHANGES WITHOUT FURTHER NOTICE TO ANY PRODUCTS HEREIN TO IMPROVE RELIABILITY, FUNCTION OR DESIGN.

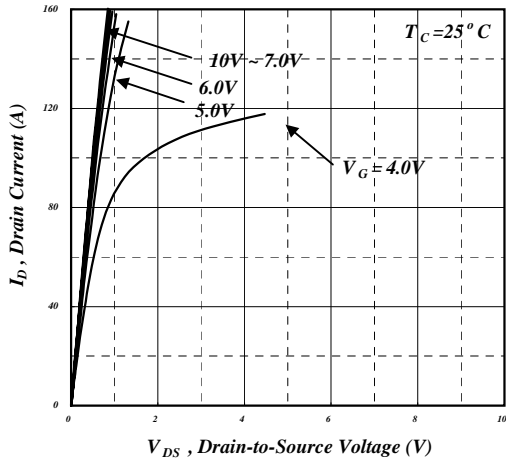

Fig 1. Typical Output Characteristics

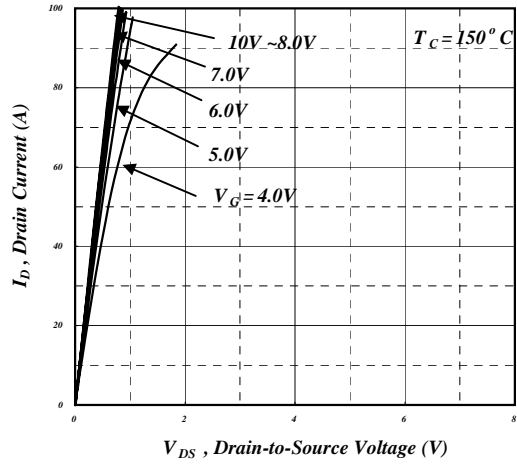

Fig 2. Typical Output Characteristics

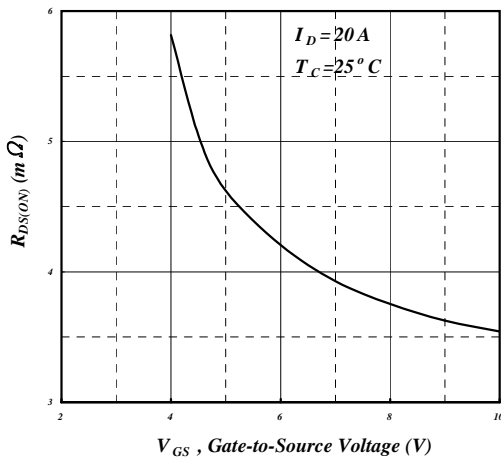

Fig 3. On-Resistance v.s. Gate Voltage

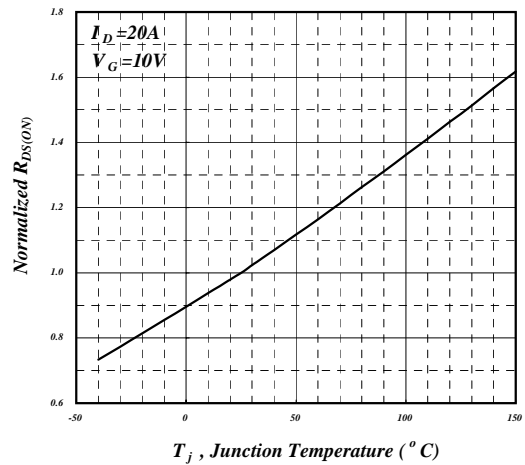

Fig 4. Normalized On-Resistance v.s. Junction Temperature

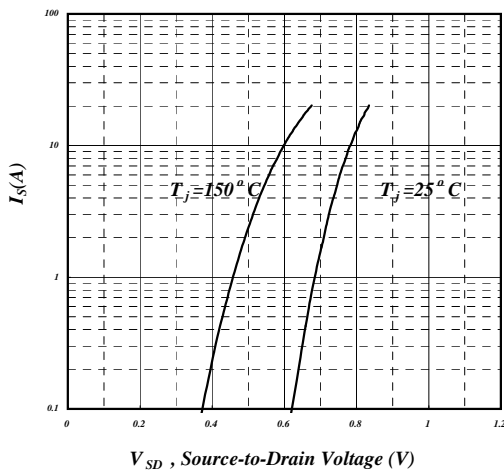

Fig 5. Forward Characteristic of Reverse Diode

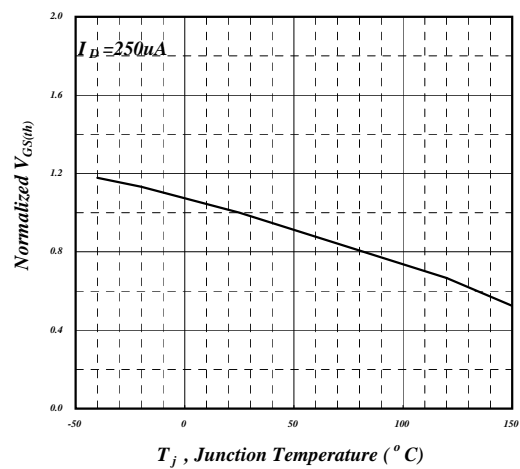

Fig 6. Gate Threshold Voltage v.s. Junction Temperature

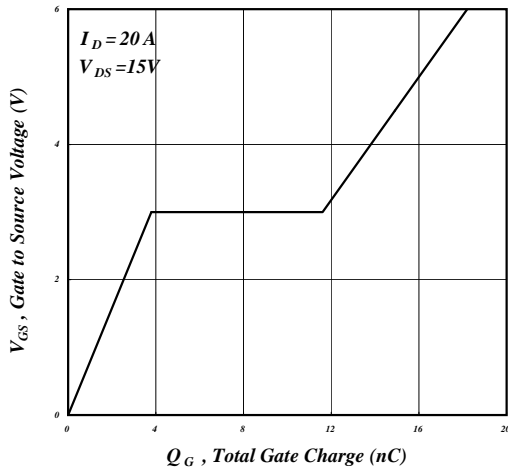

Fig 7. Gate Charge Characteristics

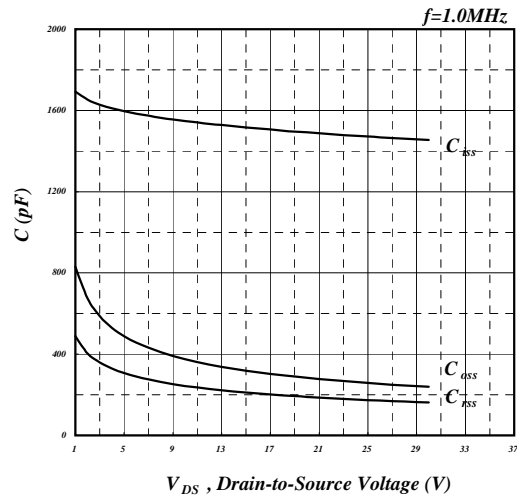

Fig 8. Typical Capacitance Characteristics

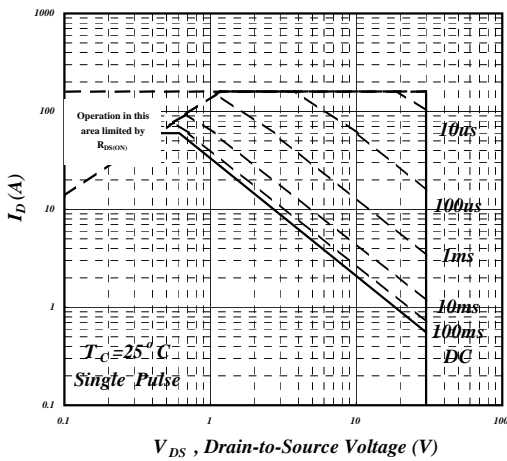

Fig 9. Maximum Safe Operating Area

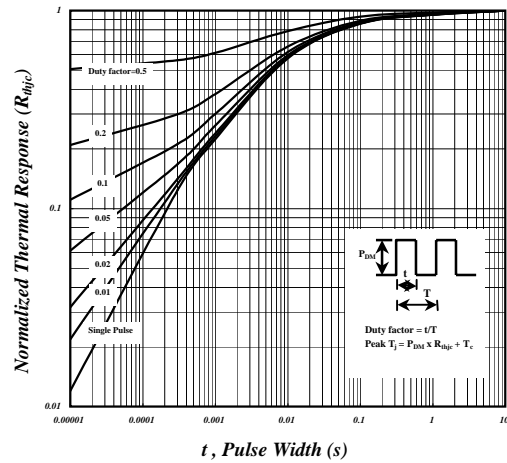

Fig 10. Effective Transient Thermal Impedance

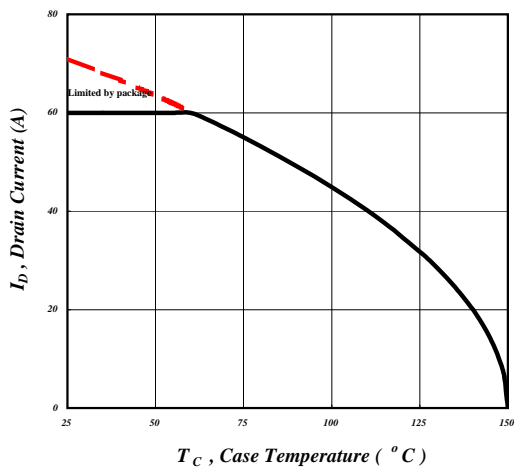

Fig 11. Drain Current v.s. Case Temperature

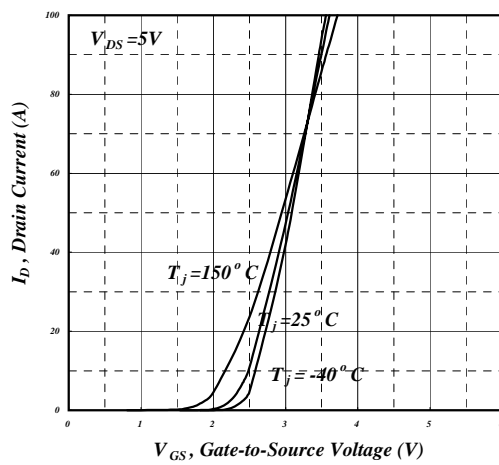

Fig 12. Transfer Characteristics

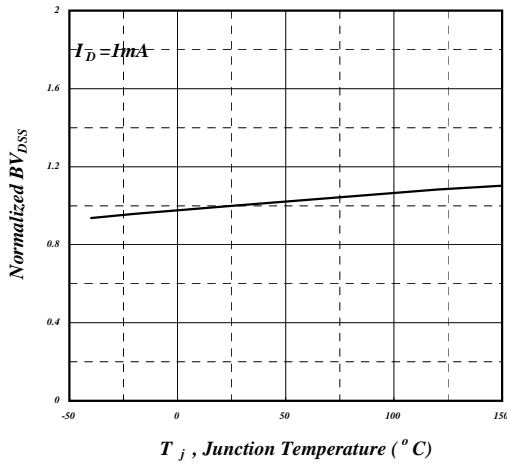

Fig 13. Normalized  $BV_{DSS}$  v.s. Junction

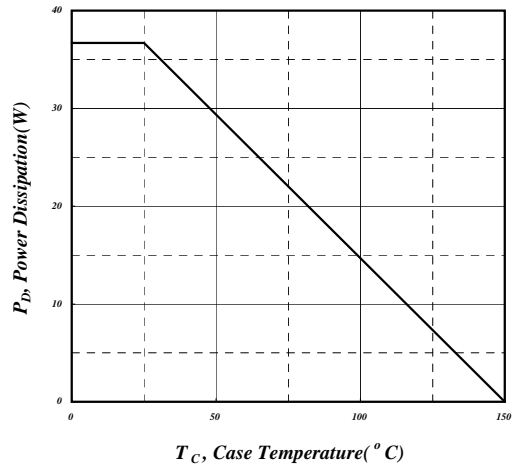

Fig 14. Total Power Dissipation

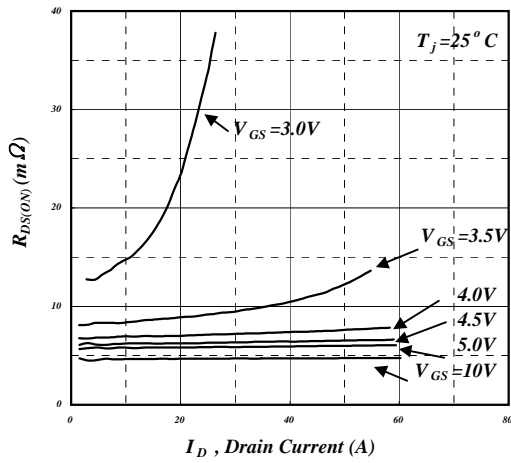
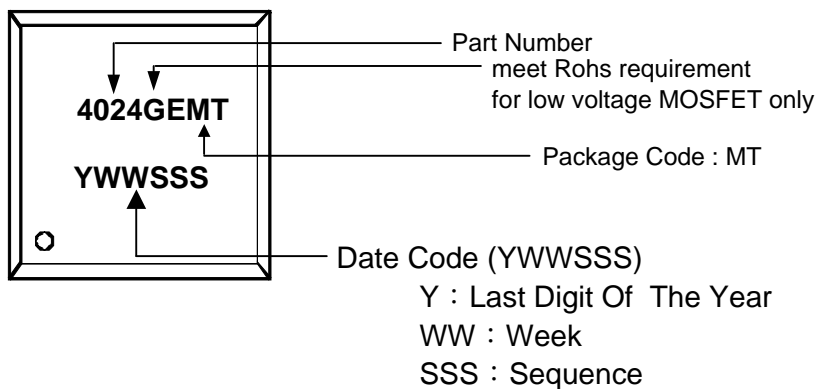

Fig 15. Typ. Drain-Source on State Resistance



# AP4024GEMT-HF

## MARKING INFORMATION





## Package Outline : PMPAK 5x6

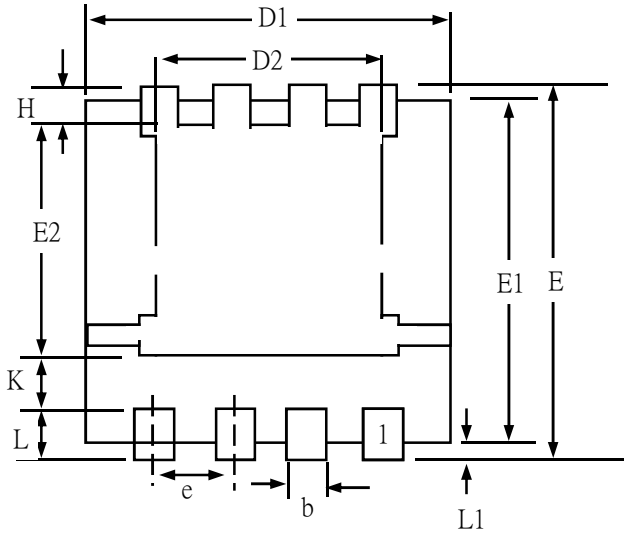

BACKSIDE VIEW

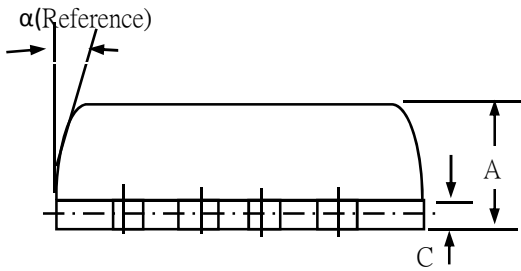

SYMBOLS	Millimeters		
	MIN	NOM	MAX
A	0.90	1.10	1.30
b	0.33	0.41	0.51
C	0.254(Ref.)		
D1	4.80	4.90	5.10
D2	3.61	4.00	4.40
E	5.80	6.00	6.20
E1 (Ref.)	5.60	5.75	5.90
E2 (Ref.)	3.30	3.55	3.80
e	1.27 BSC		
H	0.35	—	0.90
K (Ref.)	1.00	1.275	—
L	0.35	0.55	0.75
L1	0.06	0.13	0.20
alpha(Ref.)	0°	—	12°

- 1.All Dimension Are In Millimeters.
- 2.Dimension Does Not Include Mold Protrusions.



PMPAK 5X6(E-TYPE) FOOTPRINT :

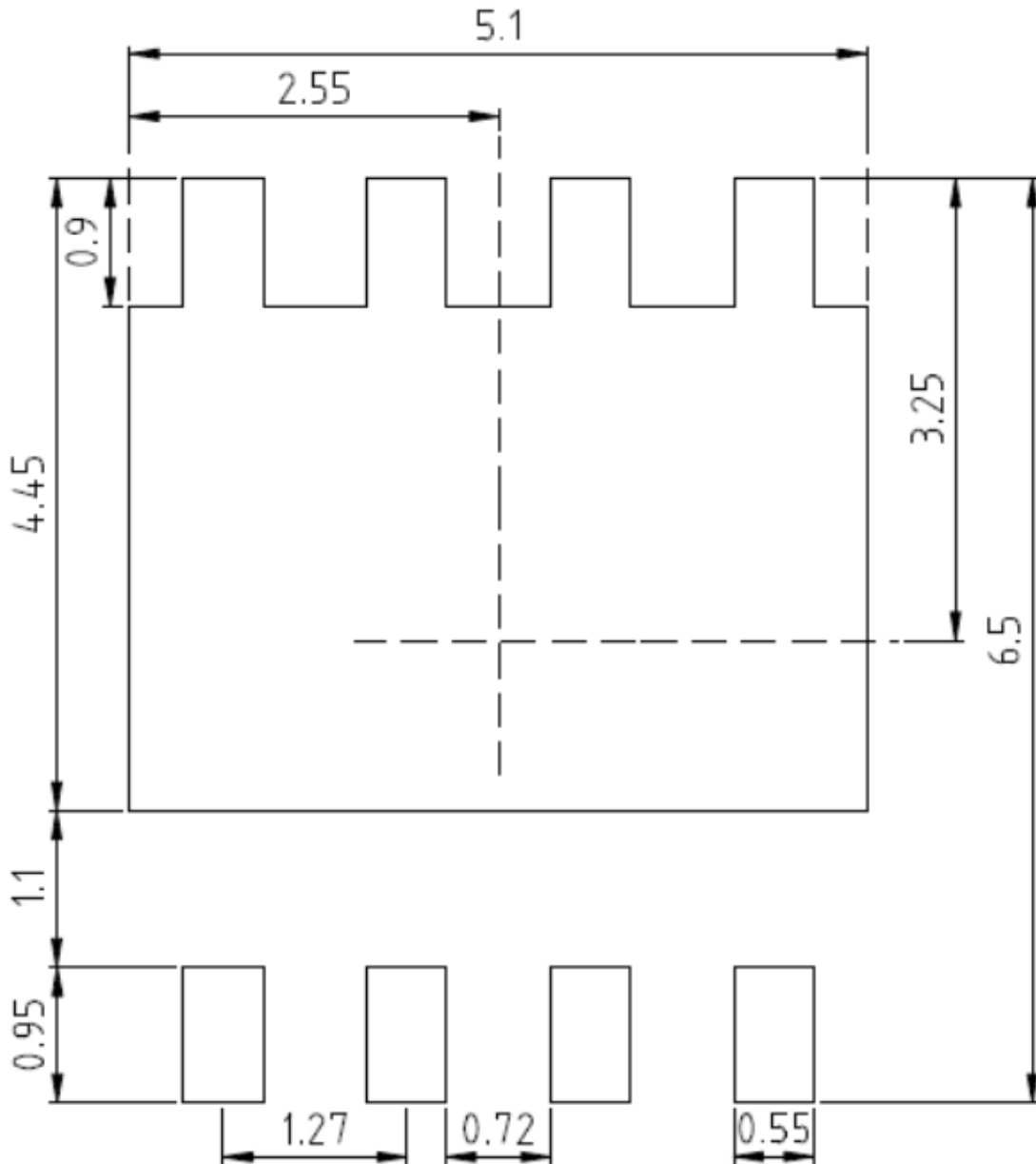

UNIT: mm