

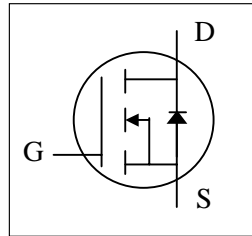

- ▼ Simple Drive Requirement
- ▼ Ultra-low On-resistance
- ▼ Fast Switching Characteristic
- ▼ RoHS Compliant & Halogen-Free



$BV_{DSS}$	40V
$R_{DS(ON)}$	2.5m $\Omega$
$I_D$	100A

### Description

AP4604 series are from Advanced Power innovated design and silicon process technology to achieve the lowest possible on-resistance and fast switching performance. It provides the designer with an extreme efficient device for use in a wide range of power applications.

The TO-220CFM package is widely preferred for all commercial-industrial through hole applications. The mold compound provides a high isolation voltage capability and low thermal resistance between the tab and the external heat-sink.

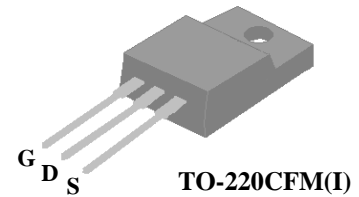

### Absolute Maximum Ratings @ $T_j=25^\circ\text{C}$ (unless otherwise specified)

Symbol	Parameter	Rating	Units
$V_{DS}$	Drain-Source Voltage	40	V
$V_{GS}$	Gate-Source Voltage	+20	V
$I_D@T_C=25^\circ\text{C}$	Drain Current, $V_{GS}$ @ 10V	100	A
$I_D@T_C=100^\circ\text{C}$	Drain Current, $V_{GS}$ @ 10V	73.4	A
$I_{DM}$	Pulsed Drain Current <sup>1</sup>	320	A
$P_D@T_C=25^\circ\text{C}$	Total Power Dissipation	50	W
$P_D@T_A=25^\circ\text{C}$	Total Power Dissipation	2.3	W
$E_{AS}$	Single Pulse Avalanche Energy <sup>3</sup>	80	mJ
$T_{STG}$	Storage Temperature Range	-55 to 175	$^\circ\text{C}$
$T_J$	Operating Junction Temperature Range	-55 to 175	$^\circ\text{C}$

### Thermal Data

Symbol	Parameter	Value	Units
Rthj-c	Maximum Thermal Resistance, Junction-case	3	$^\circ\text{C}/\text{W}$
Rthj-a	Maximum Thermal Resistance, Junction-ambient	65	$^\circ\text{C}/\text{W}$



# AP4604I

## Electrical Characteristics @T<sub>j</sub>=25°C(unless otherwise specified)

Symbol	Parameter	Test Conditions	Min.	Typ.	Max.	Units
BV <sub>DSS</sub>	Drain-Source Breakdown Voltage	V <sub>GS</sub> =0V, I <sub>D</sub> =250uA	40	-	-	V
R <sub>DS(ON)</sub>	Static Drain-Source On-Resistance <sup>2</sup>	V <sub>GS</sub> =10V, I <sub>D</sub> =30A	-	-	2.5	mΩ
V <sub>GS(th)</sub>	Gate Threshold Voltage	V <sub>DS</sub> =V <sub>GS</sub> , I <sub>D</sub> =250uA	2	-	4	V
g <sub>fs</sub>	Forward Transconductance	V <sub>DS</sub> =10V, I <sub>D</sub> =40A	-	120	-	S
I <sub>DSS</sub>	Drain-Source Leakage Current	V <sub>DS</sub> =32V, V <sub>GS</sub> =0V	-	-	10	uA
I <sub>GSS</sub>	Gate-Source Leakage	V <sub>GS</sub> = ±20V, V <sub>DS</sub> =0V	-	-	±100	nA
Q <sub>g</sub>	Total Gate Charge	I <sub>D</sub> =40A	-	105	168	nC
Q <sub>gs</sub>	Gate-Source Charge	V <sub>DS</sub> =32V	-	20	-	nC
Q <sub>gd</sub>	Gate-Drain ("Miller") Charge	V <sub>GS</sub> =10V	-	44	-	nC
t <sub>d(on)</sub>	Turn-on Delay Time	V <sub>DS</sub> =20V	-	22	-	ns
t <sub>r</sub>	Rise Time	I <sub>D</sub> =40A	-	84	-	ns
t <sub>d(off)</sub>	Turn-off Delay Time	R <sub>G</sub> =3.3 Ω	-	50	-	ns
t <sub>f</sub>	Fall Time	V <sub>GS</sub> =10V	-	30	-	ns
C <sub>iss</sub>	Input Capacitance	V <sub>GS</sub> =0V	-	5330	8528	pF
C <sub>oss</sub>	Output Capacitance	V <sub>DS</sub> =25V	-	1100	-	pF
C <sub>rss</sub>	Reverse Transfer Capacitance	f=1.0MHz	-	340	-	pF
R <sub>g</sub>	Gate Resistance	f=1.0MHz	-	1.2	2.4	Ω

## Source-Drain Diode

Symbol	Parameter	Test Conditions	Min.	Typ.	Max.	Units
V <sub>SD</sub>	Forward On Voltage <sup>2</sup>	I <sub>S</sub> =40A, V <sub>GS</sub> =0V	-	-	1.2	V
t <sub>rr</sub>	Reverse Recovery Time	I <sub>S</sub> =40A, V <sub>GS</sub> =0V	-	40	-	ns
Q <sub>rr</sub>	Reverse Recovery Charge	dI/dt=100A/μs	-	38	-	nC

### Notes:

- 1.Pulse width limited by Max. junction temperature.
- 2.Pulse test
- 3.Starting T<sub>j</sub>=25°C , V<sub>DD</sub>=25V , L=0.1mH , R<sub>G</sub>=25 Ω

THIS PRODUCT IS SENSITIVE TO ELECTROSTATIC DISCHARGE, PLEASE HANDLE WITH CAUTION.

USE OF THIS PRODUCT AS A CRITICAL COMPONENT IN LIFE SUPPORT OR OTHER SIMILAR SYSTEMS IS NOT AUTHORIZED.

APEC DOES NOT ASSUME ANY LIABILITY ARISING OUT OF THE APPLICATION OR USE OF ANY PRODUCT OR CIRCUIT DESCRIBED HEREIN; NEITHER DOES IT CONVEY ANY LICENSE UNDER ITS PATENT RIGHTS, NOR THE RIGHTS OF OTHERS.

APEC RESERVES THE RIGHT TO MAKE CHANGES WITHOUT FURTHER NOTICE TO ANY PRODUCTS HEREIN TO IMPROVE RELIABILITY, FUNCTION OR DESIGN.

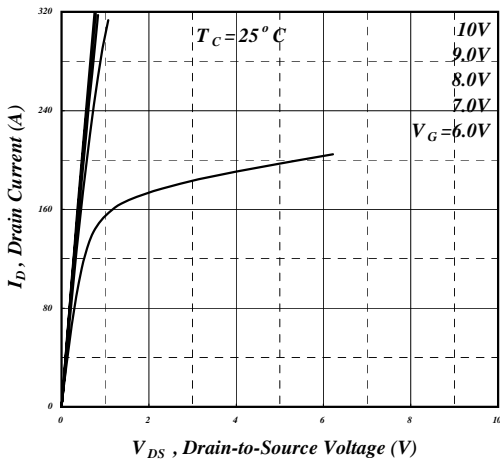

Fig 1. Typical Output Characteristics

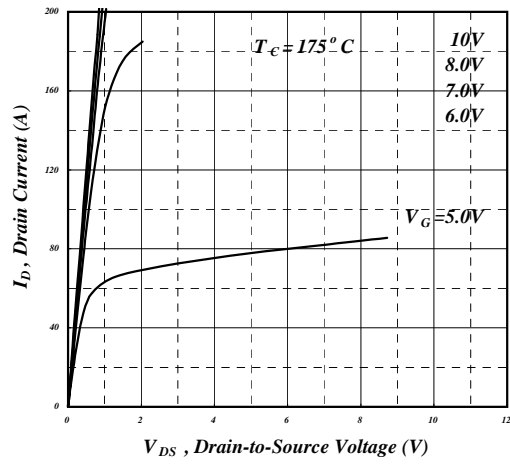

Fig 2. Typical Output Characteristics

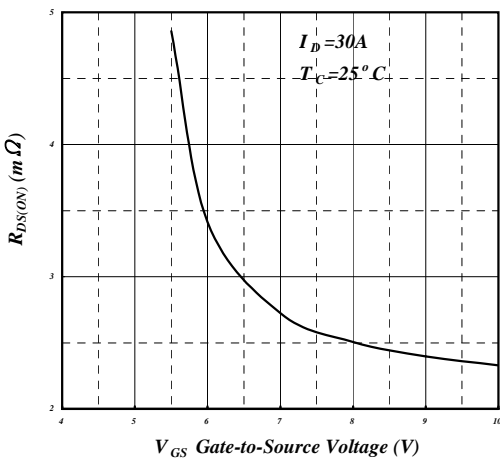

Fig 3. On-Resistance v.s. Gate Voltage

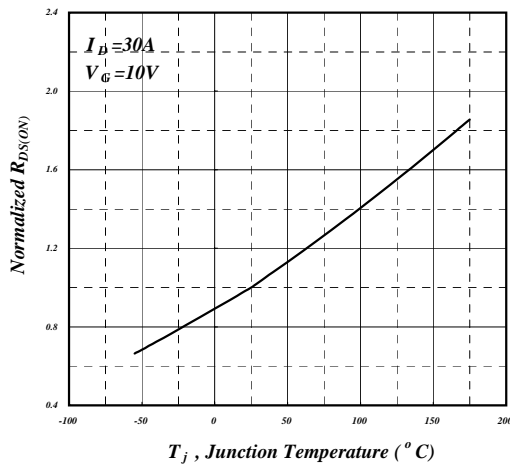

Fig 4. Normalized On-Resistance v.s. Junction Temperature

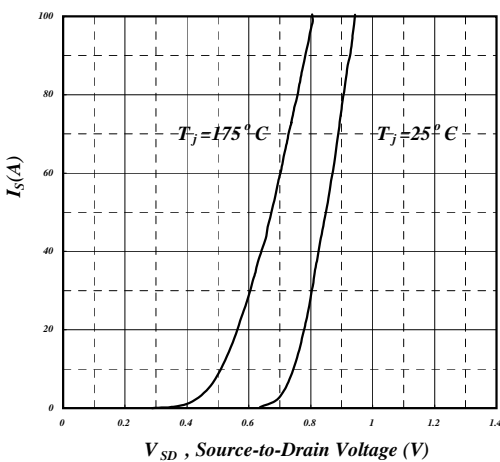

Fig 5. Forward Characteristic of Reverse Diode

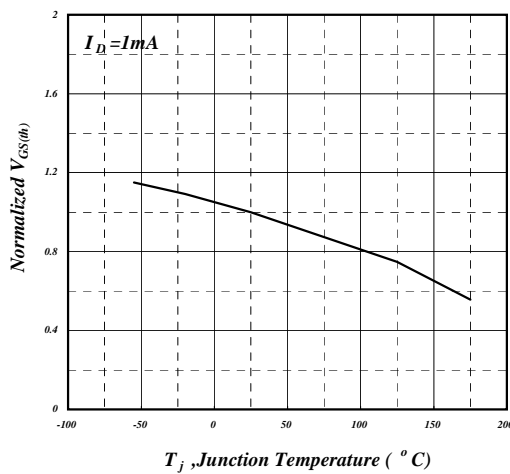

Fig 6. Gate Threshold Voltage v.s. Junction Temperature

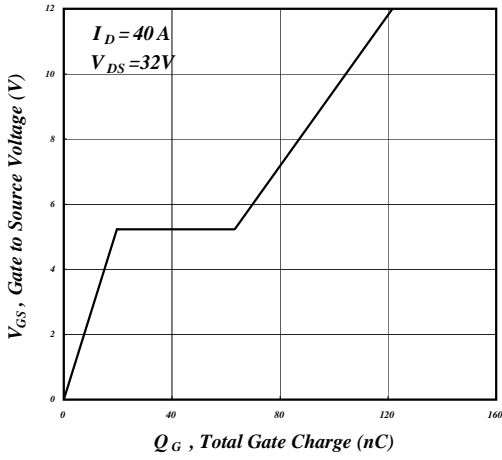

Fig 7. Gate Charge Characteristics

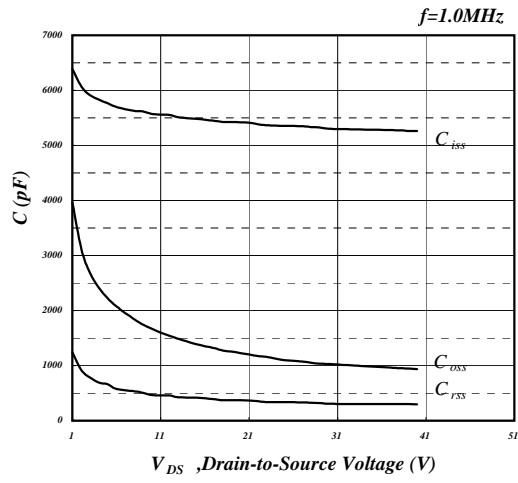

Fig 8. Typical Capacitance Characteristics

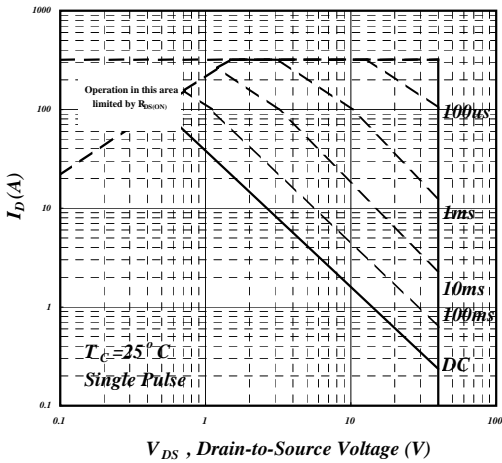

Fig 9. Maximum Safe Operating Area

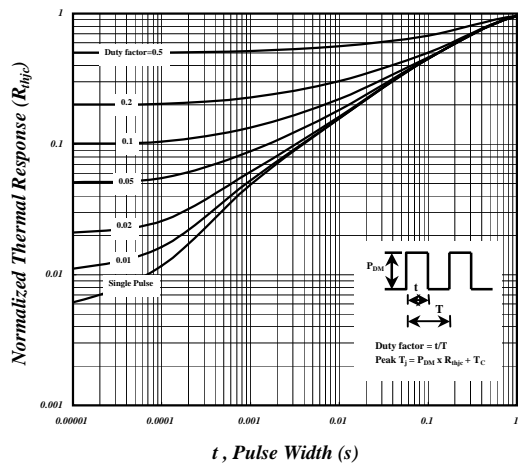

Fig 10. Effective Transient Thermal Impedance

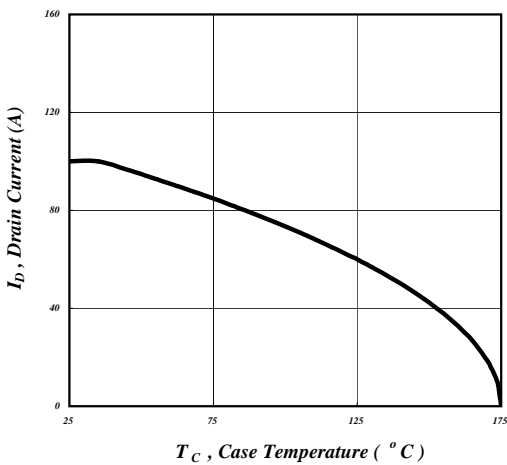

Fig 11. Drain Current v.s. Case Temperature

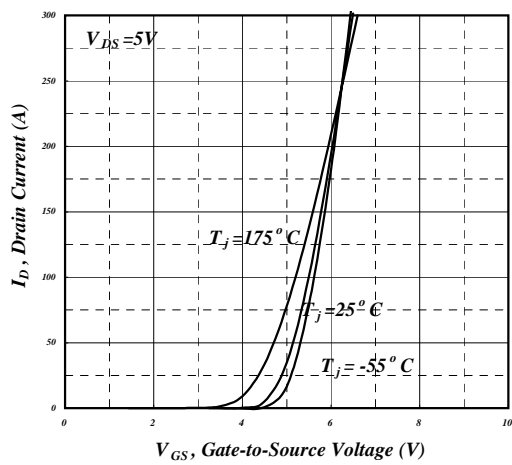

Fig 12. Transfer Characteristics

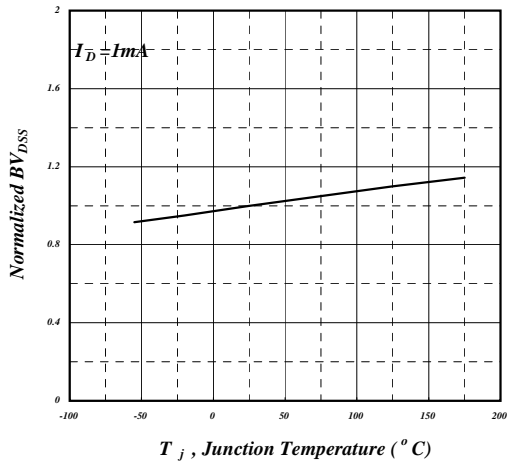

Fig 13. Normalized  $BV_{DSS}$  v.s. Junction

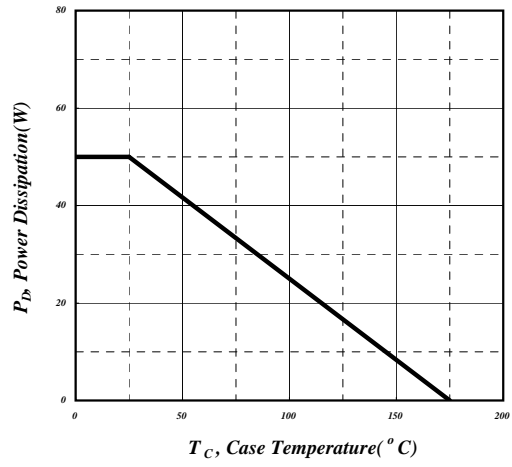

Fig 14. Total Power Dissipation

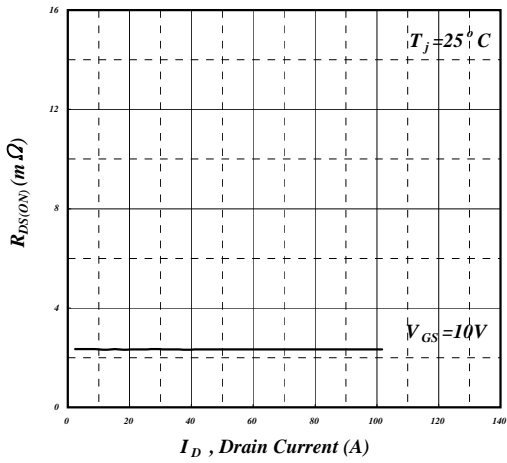
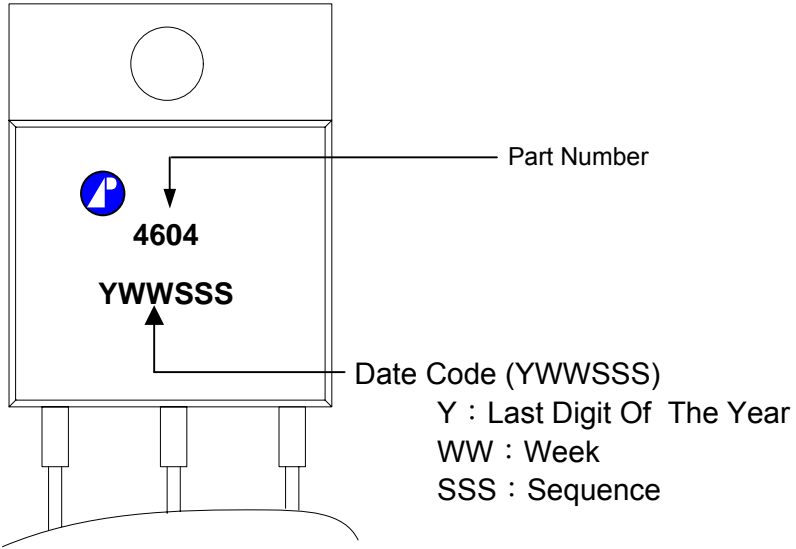

Fig 15. Typ. Drain-Source on State Resistance



# AP4604I

## MARKING INFORMATION







**TO-220CFM FOOTPRINT :**

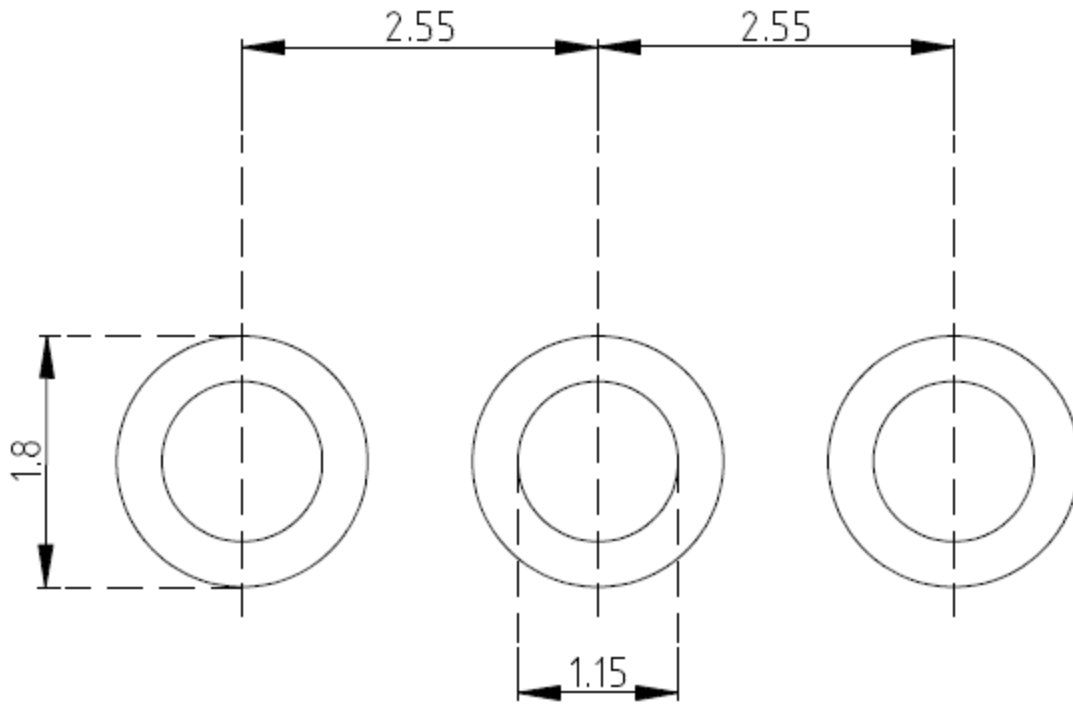

UNIT: mm