

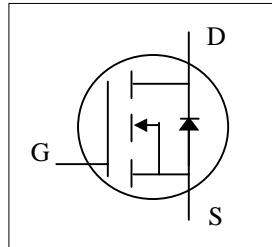

- ▼ 100% UIS Test
- ▼ Simple Drive Requirement
- ▼ Fast Switching Characteristic
- ▼ RoHS Compliant & Halogen-Free

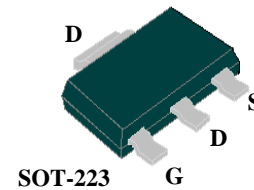

BV_{DSS}	600V
$R_{DS(ON)}$	4.8 Ω
I_D^3	1.8A



Description

AP60AN4K8 series are from the innovated design and silicon process technology to achieve the lowest possible on-resistance and fast switching performance. It provides the designer with an extreme efficient device for use in a wide range of power applications.

The SOT-223 package is designed for surface mount application, larger heatsink than SO-8 and SOT package.

Absolute Maximum Ratings @ $T_j=25^\circ\text{C}$ (unless otherwise specified)

Symbol	Parameter	Rating	Units
V_{DS}	Drain-Source Voltage	600	V
V_{GS}	Gate-Source Voltage	± 30	V
$I_D @ T_C=25^\circ\text{C}$	Drain Current, $V_{GS} @ 10V^3$	1.8	A
I_{DM}	Pulsed Drain Current ¹	7.2	A
$P_D @ T_A=25^\circ\text{C}$	Total Power Dissipation ⁵	2.78	W
E_{AS}	Single Pulse Avalanche Energy ⁴	20	mJ
T_{STG}	Storage Temperature Range	-55 to 150	$^\circ\text{C}$
T_J	Operating Junction Temperature Range	-55 to 150	$^\circ\text{C}$

Thermal Data

Symbol	Parameter	Value	Units
Rthj-a	Maximum Thermal Resistance, Junction-ambient ⁵	45	$^\circ\text{C}/\text{W}$



AP60AN4K8K

Electrical Characteristics @ $T_j=25^{\circ}\text{C}$ (unless otherwise specified)

Symbol	Parameter	Test Conditions	Min.	Typ.	Max.	Units
BV_{DSS}	Drain-Source Breakdown Voltage	$V_{GS}=0V, I_D=250\mu A$	600	-	-	V
$R_{DS(ON)}$	Static Drain-Source On-Resistance ²	$V_{GS}=10V, I_D=0.9A$	-	-	4.8	Ω
$V_{GS(th)}$	Gate Threshold Voltage	$V_{DS}=V_{GS}, I_D=250\mu A$	2	-	4	V
g_{fs}	Forward Transconductance	$V_{DS}=20V, I_D=0.9A$	-	2.8	-	S
I_{DSS}	Drain-Source Leakage Current	$V_{DS}=480V, V_{GS}=0V$	-	-	100	μA
I_{GSS}	Gate-Source Leakage	$V_{GS}=\pm 30V, V_{DS}=0V$	-	-	± 1	μA
Q_g	Total Gate Charge	$I_D=1A$	-	9.5	15.2	nC
Q_{gs}	Gate-Source Charge	$V_{DS}=480V$	-	1.7	-	nC
Q_{gd}	Gate-Drain ("Miller") Charge	$V_{GS}=10V$	-	4	-	nC
$t_{d(on)}$	Turn-on Delay Time	$V_{DD}=300V$	-	7	-	ns
t_r	Rise Time	$I_D=1.8A$	-	6	-	ns
$t_{d(off)}$	Turn-off Delay Time	$R_G=10\Omega$	-	14	-	ns
t_f	Fall Time	$V_{GS}=10V$	-	11	-	ns
C_{iss}	Input Capacitance	$V_{GS}=0V$	-	300	480	pF
C_{oss}	Output Capacitance	$V_{DS}=100V$	-	20	-	pF
C_{rss}	Reverse Transfer Capacitance	$f=1.0\text{MHz}$	-	8	-	pF
R_g	Gate Resistance	$f=1.0\text{MHz}$	-	3.3	6.6	Ω

Source-Drain Diode

Symbol	Parameter	Test Conditions	Min.	Typ.	Max.	Units
V_{SD}	Forward On Voltage ²	$I_S=0.9A, V_{GS}=0V$	-	-	1.5	V
t_{rr}	Reverse Recovery Time	$I_S=1.8A, V_{GS}=0V$	-	290	-	ns
Q_{rr}	Reverse Recovery Charge	$di/dt=100A/\mu s$	-	750	-	nC

Notes:

1. Pulse width limited by max. junction temperature.
2. Pulse test
3. Ensure that the junction temperature does not exceed T_{Jmax} .
4. Starting $T_j=25^{\circ}\text{C}$, $V_{DD}=90V$, $L=10\text{mH}$, $R_G=25\Omega$, $V_{GS}=10V$
5. Surface mounted on 1 in² copper pad of FR4 board, $t \leq 10\text{sec}$; 120 $^{\circ}\text{C}/\text{W}$ when mounted on Min. copper pad.

THIS PRODUCT IS SENSITIVE TO ELECTROSTATIC DISCHARGE, PLEASE HANDLE WITH CAUTION.

USE OF THIS PRODUCT AS A CRITICAL COMPONENT IN LIFE SUPPORT OR OTHER SIMILAR SYSTEMS IS NOT AUTHORIZED.

APEC DOES NOT ASSUME ANY LIABILITY ARISING OUT OF THE APPLICATION OR USE OF ANY PRODUCT OR CIRCUIT DESCRIBED HEREIN; NEITHER DOES IT CONVEY ANY LICENSE UNDER ITS PATENT RIGHTS, NOR THE RIGHTS OF OTHERS.

APEC RESERVES THE RIGHT TO MAKE CHANGES WITHOUT FURTHER NOTICE TO ANY PRODUCTS HEREIN TO IMPROVE RELIABILITY, FUNCTION OR DESIGN.

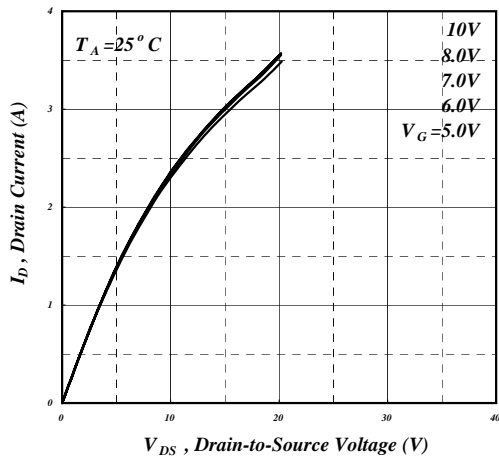

Fig 1. Typical Output Characteristics

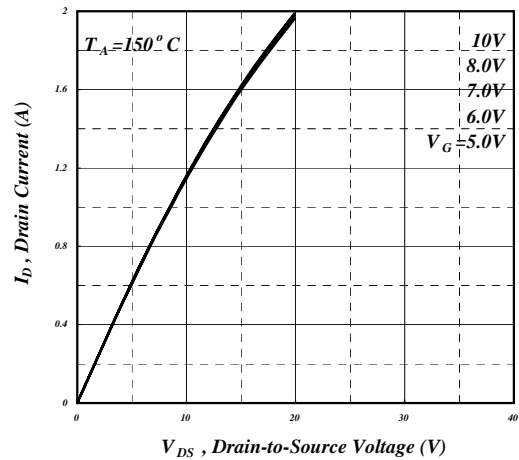

Fig 2. Typical Output Characteristics

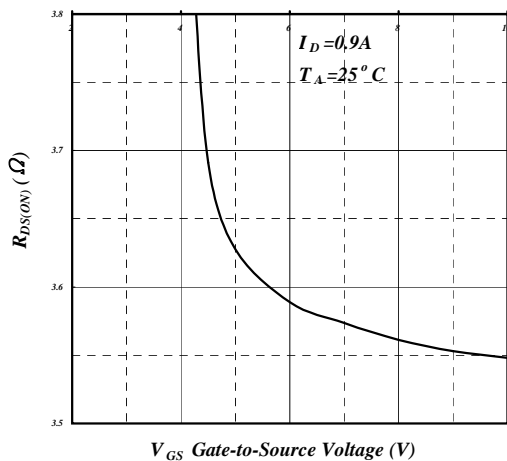

Fig 3. On-Resistance v.s. Gate Voltage

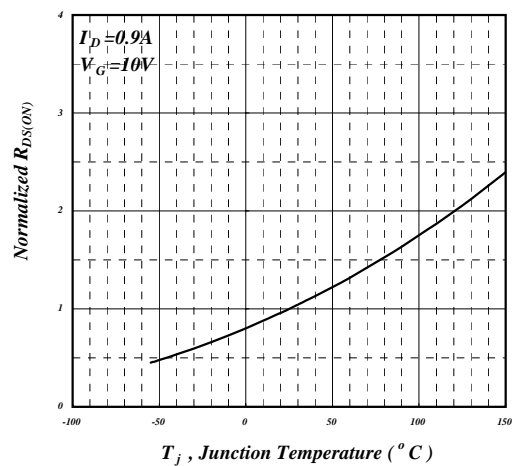

Fig 4. Normalized On-Resistance v.s. Junction Temperature

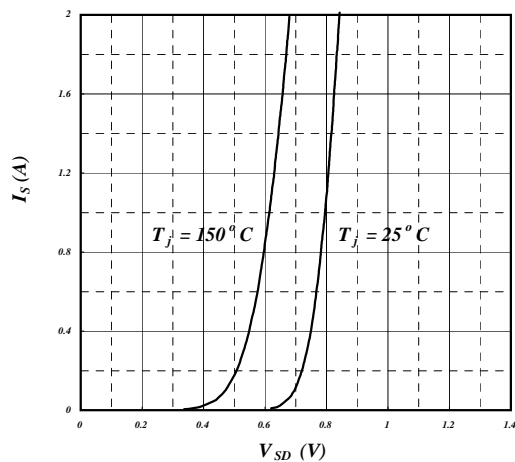

Fig 5. Forward Characteristic of Reverse Diode

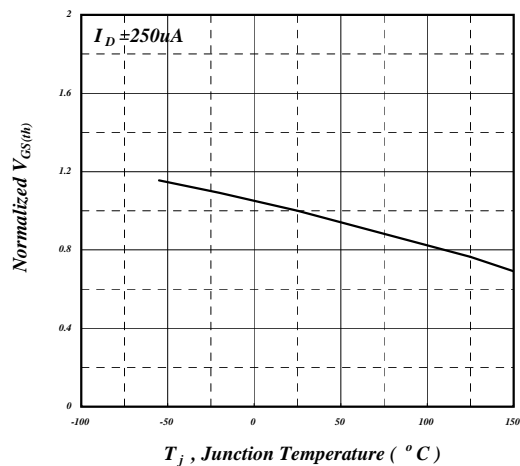

Fig 6. Gate Threshold Voltage v.s. Junction Temperature

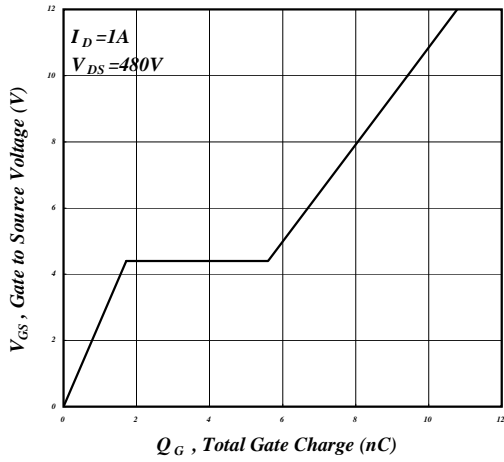

Fig 7. Gate Charge Characteristics

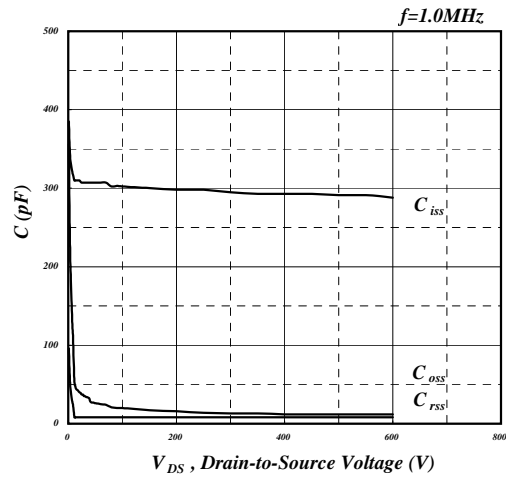

Fig 8. Typical Capacitance Characteristics

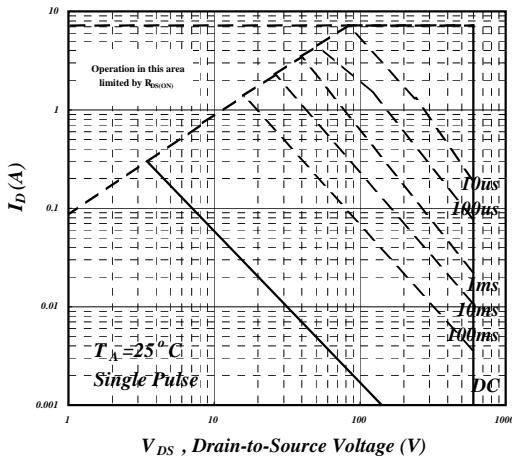

Fig 9. Maximum Safe Operating Area

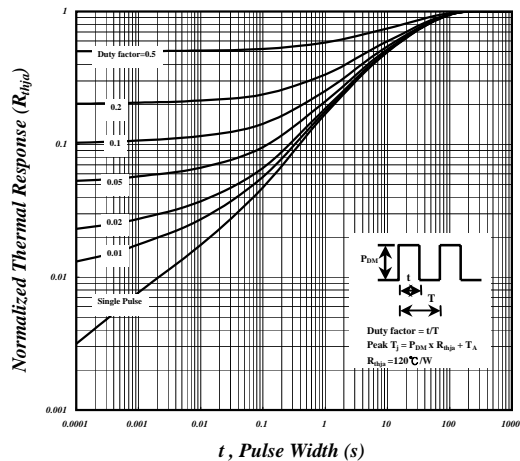

Fig 10. Effective Transient Thermal Impedance

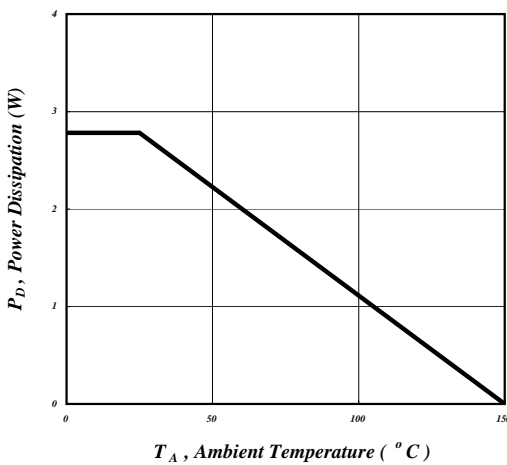

Fig 11. Total Power Dissipation

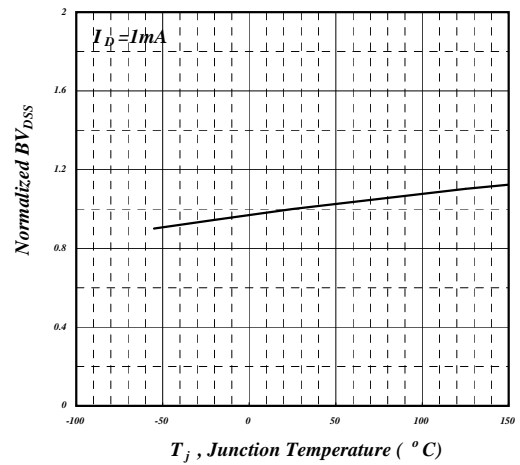
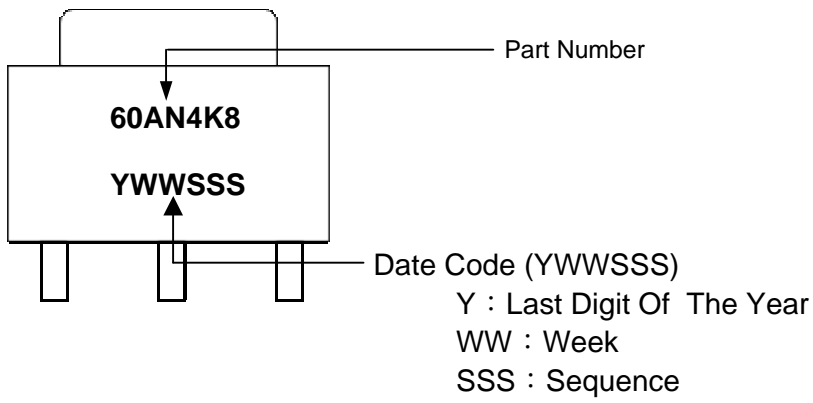

Fig 12. Normalized BV_{DS} v.s. Junction Temperature



MARKING INFORMATION





Package Outline : SOT-223

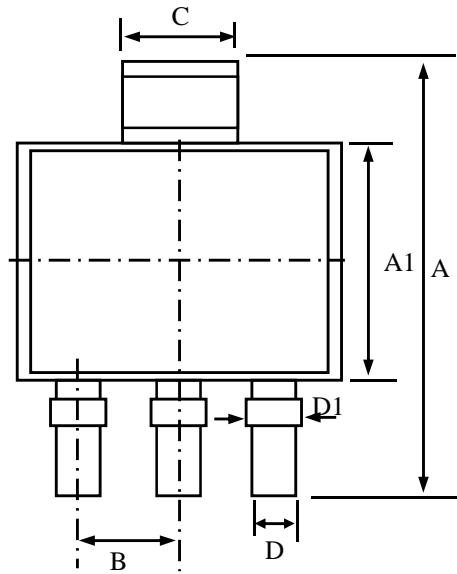

SYMBOLS	Millimeters		
	MIN	NOM	MAX
A	6.70	7.00	7.30
B	---	2.30	---
C	2.90	3.00	3.10
D	0.60	0.70	0.85
G	0.20	0.30	0.35
E	6.30	6.50	6.70
F	1.40	1.60	1.80
K	0.02	0.06	0.10
A1	3.30	3.50	3.70
L	0.50	0.75	1.00
D1	0.70	0.85	1.00

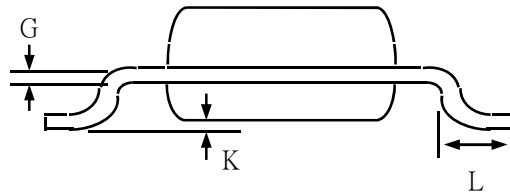
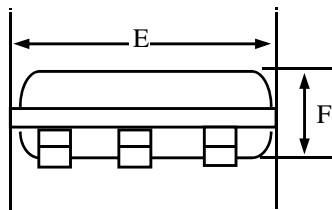

- 1.All Dimension Are In Millimeters.
- 2.Dimension Does Not Include Mold Protrusions.



SOT-223 FOOTPRINT :

