

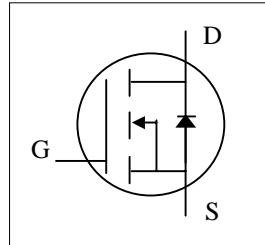

- ▼ 100% R_g & UIS Test
- ▼ Low t_{rr} / Q_{rr}
- ▼ Simple Drive Requirement
- ▼ RoHS Compliant & Halogen-Free

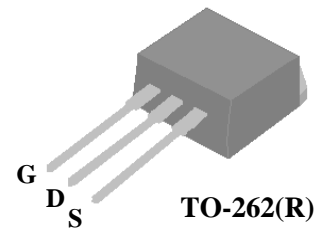

BV _{DSS}	600V
R _{DS(ON)}	115mΩ
I _D ^{3,4}	28A



Description

AP60SA115D series are from Advanced Power innovated design and silicon process technology to achieve the lowest possible on-resistance and fast switching performance. It provides the designer with an extreme efficient device for use in a wide range of power applications.

The TO-262 package is widely preferred for commercial-industrial through-hole applications and suited for low voltage applications such as DC/DC converters.

Absolute Maximum Ratings @T_j=25°C (unless otherwise specified)

Symbol	Parameter	Rating	Units
V _{DS}	Drain-Source Voltage	600	V
V _{GS}	Gate-Source Voltage	+20	V
V _{GS}	Gate-Source Voltage, AC (f > 1Hz)	+30	V
I _D @T _C =25°C	Drain Current, V _{GS} @ 10V ^{3,4}	28	A
I _D @T _C =100°C	Drain Current, V _{GS} @ 10V ^{3,4}	17.7	A
I _{DM}	Pulsed Drain Current ¹	72	A
dv/dt	MOSFET dv/dt Ruggedness (V _{DS} = 0 ... 480V)	30	V/ns
P _D @T _C =25°C	Total Power Dissipation	178	W
P _D @T _A =25°C	Total Power Dissipation	2	W
E _{AS}	Single Pulse Avalanche Energy ⁵	200	mJ
dv/dt	Peak Diode Recovery dv/dt ⁶	15	V/ns
T _{STG}	Storage Temperature Range	-55 to 150	°C
T _J	Operating Junction Temperature Range	-55 to 150	°C

Thermal Data

Symbol	Parameter	Value	Units
R _{thj-c}	Maximum Thermal Resistance, Junction-case	0.7	°C/W
R _{thj-a}	Maximum Thermal Resistance, Junction-ambient	62	°C/W



AP60SA115DR

Electrical Characteristics @T_j=25°C(unless otherwise specified)

Symbol	Parameter	Test Conditions	Min.	Typ.	Max.	Units
BV _{DSS}	Drain-Source Breakdown Voltage	V _{GS} =0V, I _D =250uA	600	-	-	V
R _{DS(ON)}	Static Drain-Source On-Resistance ²	V _{GS} =10V, I _D =9.6A	-	-	115	mΩ
V _{GS(th)}	Gate Threshold Voltage	V _{DS} =V _{GS} , I _D =250uA	2	-	4	V
g _{fs}	Forward Transconductance	V _{DS} =10V, I _D =9.6A	-	13	-	S
I _{DSS}	Drain-Source Leakage Current	V _{DS} =480V, V _{GS} =0V	-	-	100	uA
I _{GSS}	Gate-Source Leakage	V _{GS} =+20V, V _{DS} =0V	-	-	±1	uA
Q _g	Total Gate Charge	I _D =14A	-	69	110	nC
Q _{gs}	Gate-Source Charge	V _{DS} =480V	-	17	-	nC
Q _{gd}	Gate-Drain ("Miller") Charge	V _{GS} =10V	-	33	-	nC
t _{d(on)}	Turn-on Delay Time	V _{DD} =300V	-	19	-	ns
t _r	Rise Time	I _D =14A	-	32	-	ns
t _{d(off)}	Turn-off Delay Time	R _G =3.3Ω	-	54	-	ns
t _f	Fall Time	V _{GS} =10V	-	27	-	ns
C _{iss}	Input Capacitance	V _{GS} =0V	-	2450	3920	pF
C _{oss}	Output Capacitance	V _{DS} =100V	-	87	-	pF
C _{rss}	Reverse Transfer Capacitance	f=1.0MHz	-	6	-	pF
R _g	Gate Resistance	f=1.0MHz	-	2.5	5	Ω

Source-Drain Diode

Symbol	Parameter	Test Conditions	Min.	Typ.	Max.	Units
V _{SD}	Forward On Voltage ²	I _S =9.6A, V _{GS} =0V	-	0.85	-	V
t _{rr}	Reverse Recovery Time	I _S =14A, V _{GS} =0V	-	150	-	ns
Q _{rr}	Reverse Recovery Charge	dI/dt=100A/μs	-	1.3	-	μC

Notes:

- 1.Pulse width limited by max. junction temperature.
- 2.Pulse test
- 3.Limited by max. junction temperature. Maximum duty cycle D=0.75
- 4.Ensure that the junction temperature does not exceed T_{Jmax}.
- 5.Starting T_j=25°C, V_{DD}=90V, L=100mH, R_G=25Ω, V_{GS}=10V
- 6.I_{SD} ≤ I_D, V_{DD} ≤ BV_{DSS}, starting T_J = 25°C

THIS PRODUCT IS SENSITIVE TO ELECTROSTATIC DISCHARGE, PLEASE HANDLE WITH CAUTION.

USE OF THIS PRODUCT AS A CRITICAL COMPONENT IN LIFE SUPPORT OR OTHER SIMILAR SYSTEMS IS NOT AUTHORIZED.

APEC DOES NOT ASSUME ANY LIABILITY ARISING OUT OF THE APPLICATION OR USE OF ANY PRODUCT OR CIRCUIT DESCRIBED HEREIN; NEITHER DOES IT CONVEY ANY LICENSE UNDER ITS PATENT RIGHTS, NOR THE RIGHTS OF OTHERS.

APEC RESERVES THE RIGHT TO MAKE CHANGES WITHOUT FURTHER NOTICE TO ANY PRODUCTS HEREIN TO IMPROVE RELIABILITY, FUNCTION OR DESIGN.

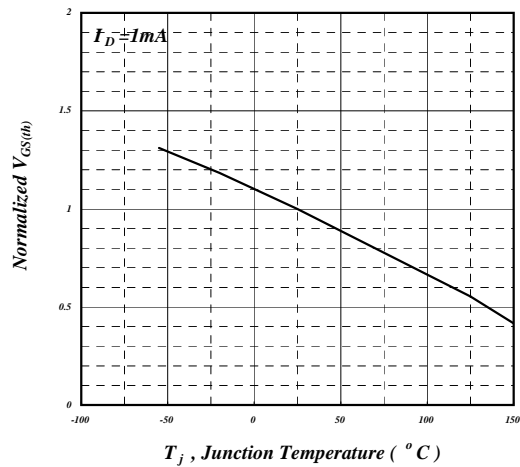
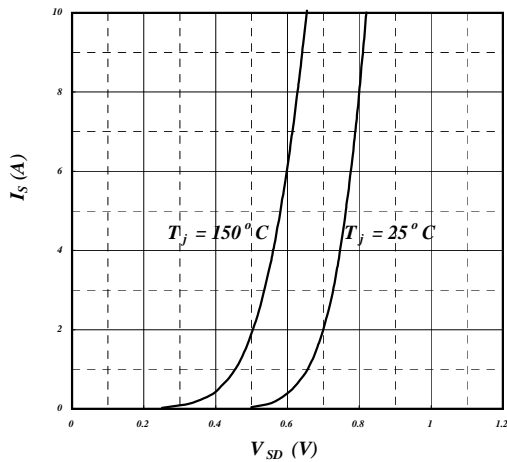
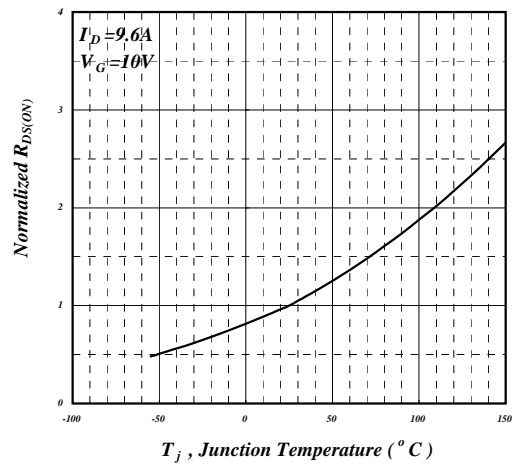
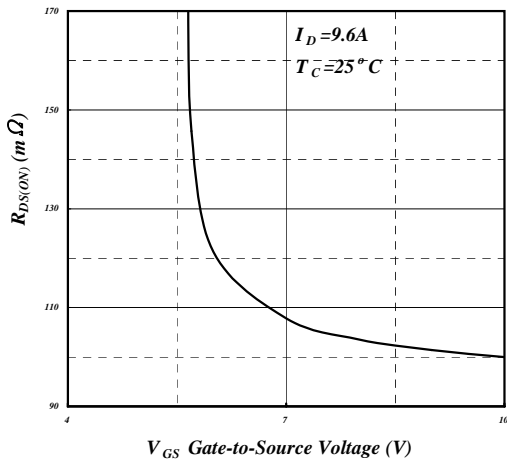
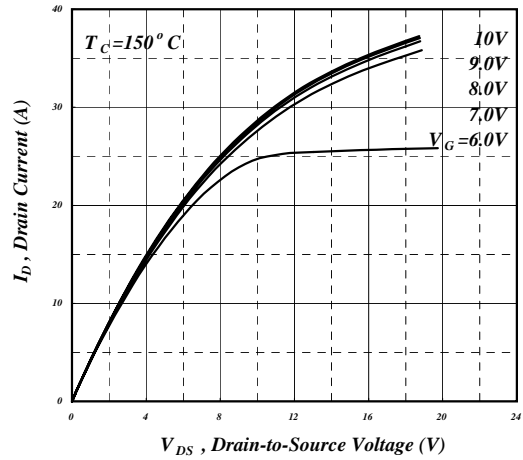
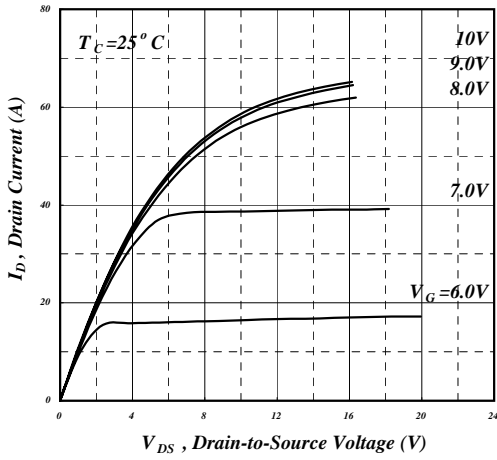

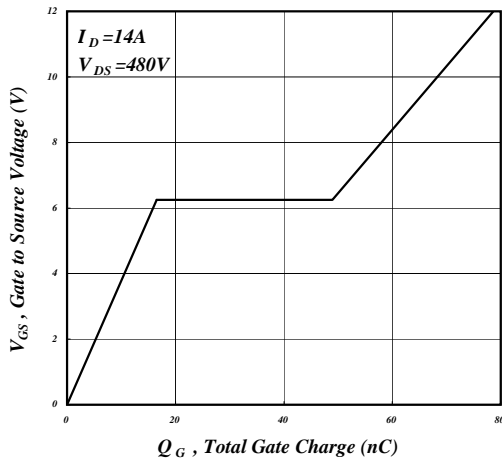

Fig 7. Gate Charge Characteristics

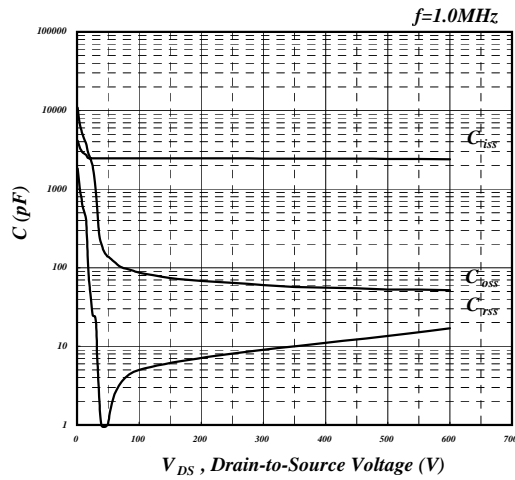

Fig 8. Typical Capacitance Characteristics

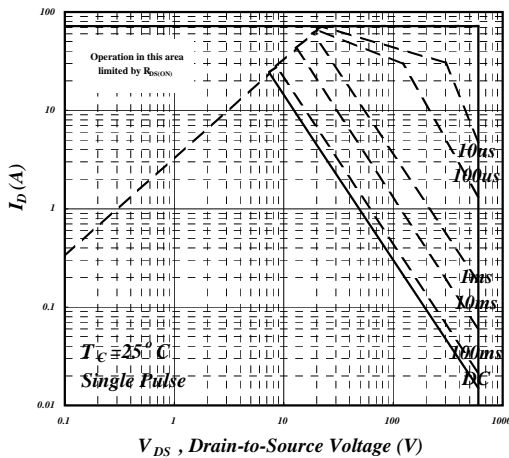

Fig 9. Maximum Safe Operating Area

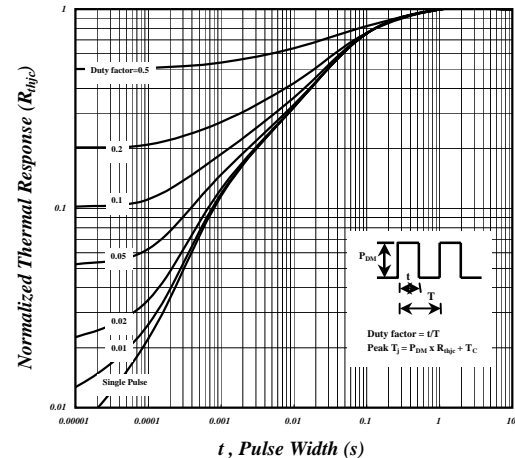

Fig 10. Effective Transient Thermal Impedance

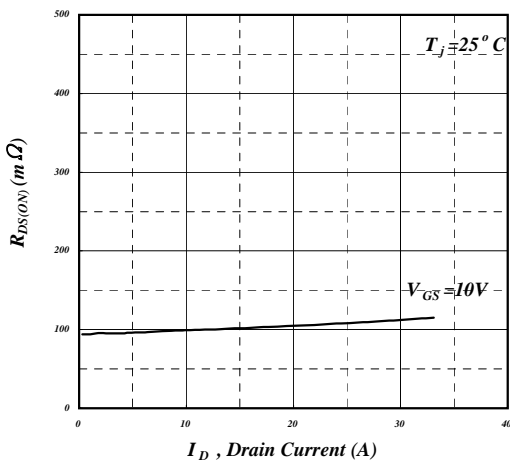

Fig 11. Typ. Drain-Source on State Resistance

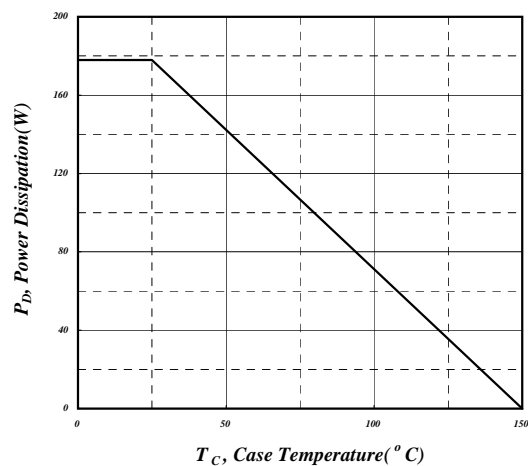
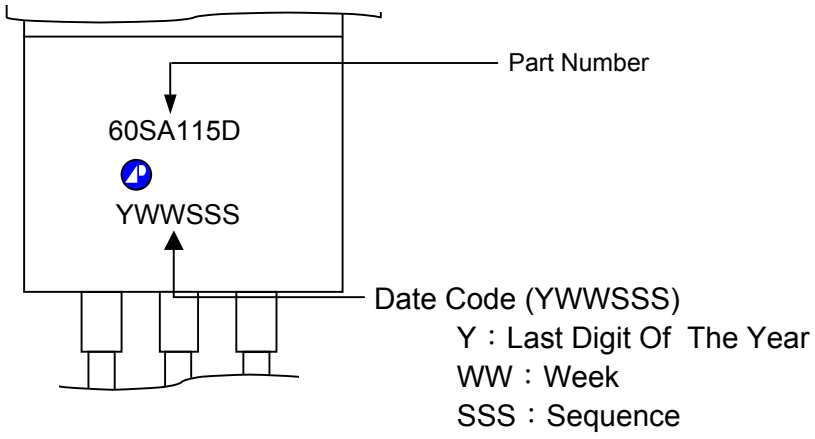

Fig 12. Total Power Dissipation



MARKING INFORMATION





Package Outline : TO-262

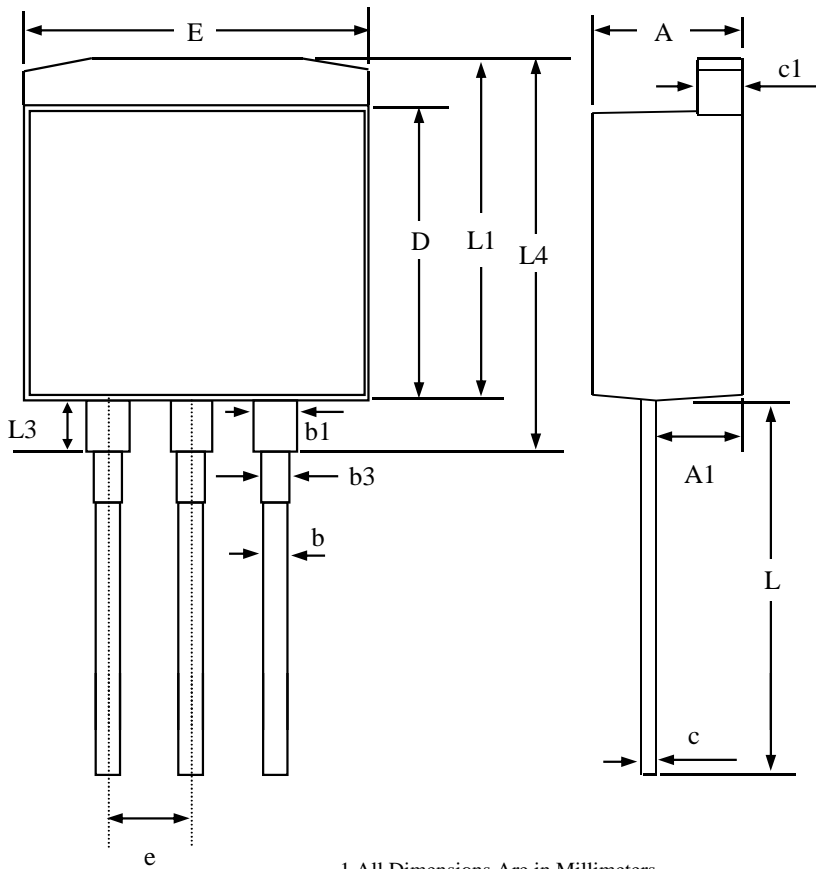

SYMBOLS	Millimeters		
	MIN	NOM	MAX
A	4.24	4.54	4.84
A1	2.10	2.50	2.90
b	0.65	0.85	1.05
b1	0.63	1.08	1.53
b3	0.75	1.08	1.40
c	0.30	0.45	0.60
c1	1.15	1.3	1.45
D	8.30	8.9	9.50
E	9.50	10	10.50
e	2.04	2.54	3.04
L	10.50	12.5	14.50
L1	8.50	10	11.50
L3	1.3 ~ 4.8 (ref)		

1. All Dimensions Are in Millimeters.
2. Dimension Does Not Include Mold Protrusions.



TO-262 FOOTPRINT :

