

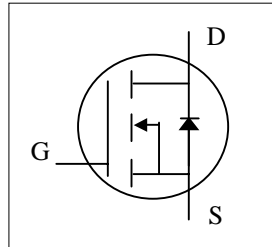

- ▼ 100% R_g & UIS Test
- ▼ Fast Switching Characteristic
- ▼ Simple Drive Requirement
- ▼ RoHS Compliant & Halogen-Free

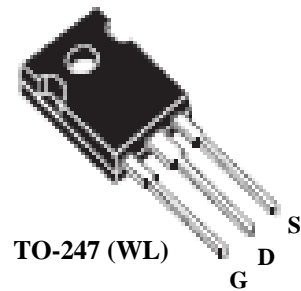

$V_{DS} @ T_{j,max.}$	700V
$R_{DS(ON)}$	0.13 Ω
I_D^3	26.2A



Description

AP65SL130A series are from Advanced Power innovated design and silicon process technology to achieve the lowest possible on-resistance and fast switching performance. It provides the designer with an extreme efficient device for use in a wide range of power applications.

The TO-247 package is widely preferred for commercial-industrial applications. The device is suited for switch mode power supplies, DC-AC converters and high current high speed switching circuits.

Absolute Maximum Ratings @ $T_j=25^\circ\text{C}$ (unless otherwise specified)

Symbol	Parameter	Rating	Units
V_{DS}	Drain-Source Voltage	650	V
V_{GS}	Gate-Source Voltage	± 20	V
$I_D @ T_C=25^\circ\text{C}$	Drain Current, $V_{GS} @ 10V^3$	26.2	A
$I_D @ T_C=100^\circ\text{C}$	Drain Current, $V_{GS} @ 10V^3$	16.5	A
I_{DM}	Pulsed Drain Current ¹	66	A
dv/dt	MOSFET dv/dt Ruggedness ($V_{DS} = 0 \dots 480V$)	50	V/ns
$P_D @ T_C=25^\circ\text{C}$	Total Power Dissipation	178	W
$P_D @ T_A=25^\circ\text{C}$	Total Power Dissipation	3.12	W
E_{AS}	Single Pulse Avalanche Energy ⁴	300	mJ
dv/dt	Peak Diode Recovery dv/dt ⁵	15	V/ns
T_{STG}	Storage Temperature Range	-55 to 150	$^\circ\text{C}$
T_J	Operating Junction Temperature Range	-55 to 150	$^\circ\text{C}$

Thermal Data

Symbol	Parameter	Value	Units
Rthj-c	Maximum Thermal Resistance, Junction-case	0.7	$^\circ\text{C}/\text{W}$
Rthj-a	Maximum Thermal Resistance, Junction-ambient	40	$^\circ\text{C}/\text{W}$



AP65SL130AWL

Electrical Characteristics @T_j=25°C(unless otherwise specified)

Symbol	Parameter	Test Conditions	Min.	Typ.	Max.	Units
BV _{DSS}	Drain-Source Breakdown Voltage	V _{GS} =0V, I _D =250uA	650	-	-	V
R _{DS(ON)}	Static Drain-Source On-Resistance ²	V _{GS} =10V, I _D =9.6A	-	-	0.13	Ω
V _{GS(th)}	Gate Threshold Voltage	V _{DS} =V _{GS} , I _D =250uA	2	-	5	V
g _{fs}	Forward Transconductance	V _{DS} =10V, I _D =14A	-	25	-	S
I _{DSS}	Drain-Source Leakage Current	V _{DS} =480V, V _{GS} =0V	-	-	100	uA
I _{GSS}	Gate-Source Leakage	V _{GS} =±20V, V _{DS} =0V	-	-	±100	nA
Q _g	Total Gate Charge	I _D =14A	-	82	131.2	nC
Q _{gs}	Gate-Source Charge	V _{DS} =480V	-	21	-	nC
Q _{gd}	Gate-Drain ("Miller") Charge	V _{GS} =10V	-	33	-	nC
t _{d(on)}	Turn-on Delay Time	V _{DD} =300V	-	24	-	ns
t _r	Rise Time	I _D =14A	-	42	-	ns
t _{d(off)}	Turn-off Delay Time	R _G =3.3Ω	-	74	-	ns
t _f	Fall Time	V _{GS} =10V	-	38	-	ns
C _{iss}	Input Capacitance	V _{GS} =0V	-	3380	5408	pF
C _{oss}	Output Capacitance	V _{DS} =100V	-	90	-	pF
C _{rss}	Reverse Transfer Capacitance	f=1.0MHz	-	11	-	pF
R _g	Gate Resistance	f=1.0MHz	-	4.5	9	Ω

Source-Drain Diode

Symbol	Parameter	Test Conditions	Min.	Typ.	Max.	Units
V _{SD}	Forward On Voltage ²	I _S =14A, V _{GS} =0V	-	0.85	-	V
t _{rr}	Reverse Recovery Time	I _S =14A, V _{GS} =0V	-	430	-	ns
Q _{rr}	Reverse Recovery Charge	di/dt=30A/μs	-	2.5	-	μC

Notes:

- 1.Pulse width limited by max. junction temperature.
- 2.Pulse test
- 3.Limited by max. junction temperature. Maximum duty cycle D=0.75
- 4.Starting T_j=25°C , V_{DD}=50V , L=150mH , R_G=25Ω
- 5.I_{SD} ≤ I_D, V_{DD} ≤ BV_{DSS}, starting T_J = 25°C

THIS PRODUCT IS SENSITIVE TO ELECTROSTATIC DISCHARGE, PLEASE HANDLE WITH CAUTION.

USE OF THIS PRODUCT AS A CRITICAL COMPONENT IN LIFE SUPPORT OR OTHER SIMILAR SYSTEMS IS NOT AUTHORIZED.

APEC DOES NOT ASSUME ANY LIABILITY ARISING OUT OF THE APPLICATION OR USE OF ANY PRODUCT OR CIRCUIT DESCRIBED HEREIN; NEITHER DOES IT CONVEY ANY LICENSE UNDER ITS PATENT RIGHTS, NOR THE RIGHTS OF OTHERS.

APEC RESERVES THE RIGHT TO MAKE CHANGES WITHOUT FURTHER NOTICE TO ANY PRODUCTS HEREIN TO IMPROVE RELIABILITY, FUNCTION OR DESIGN.

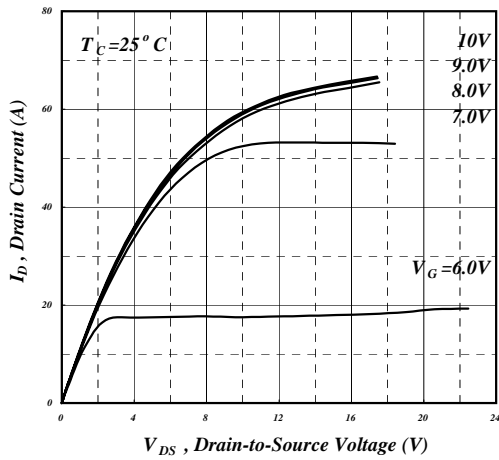

Fig 1. Typical Output Characteristics

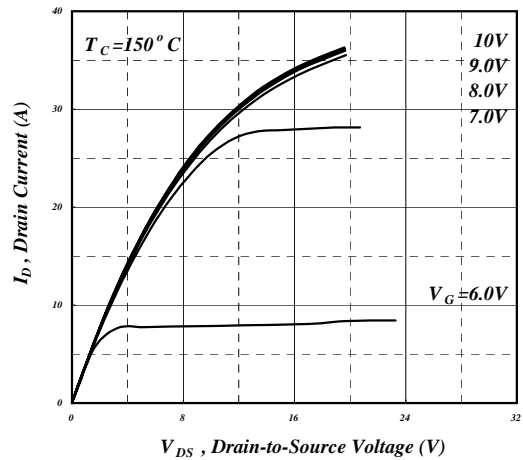

Fig 2. Typical Output Characteristics

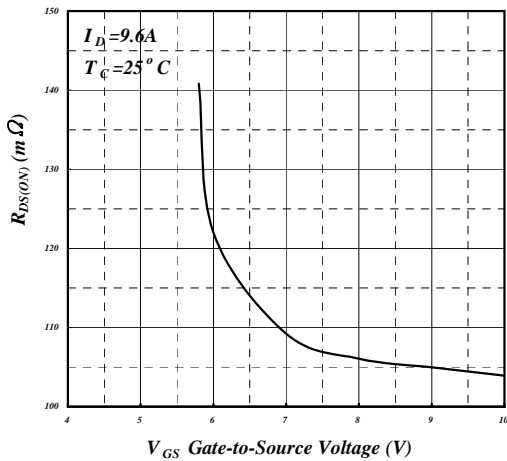

Fig 3. On-Resistance v.s. Gate Voltage

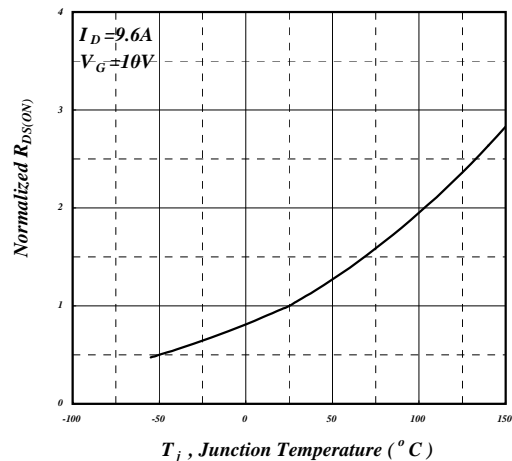

Fig 4. Normalized On-Resistance v.s. Junction Temperature

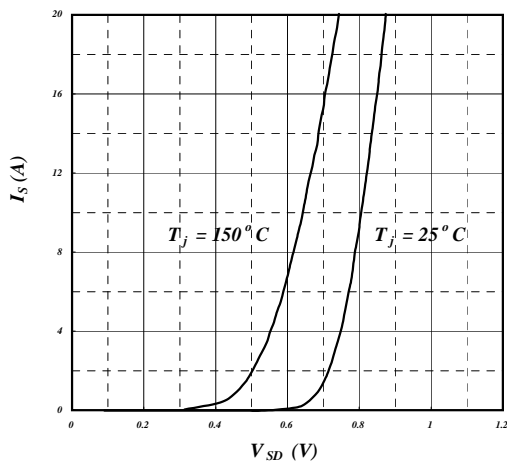

Fig 5. Forward Characteristic of Reverse Diode

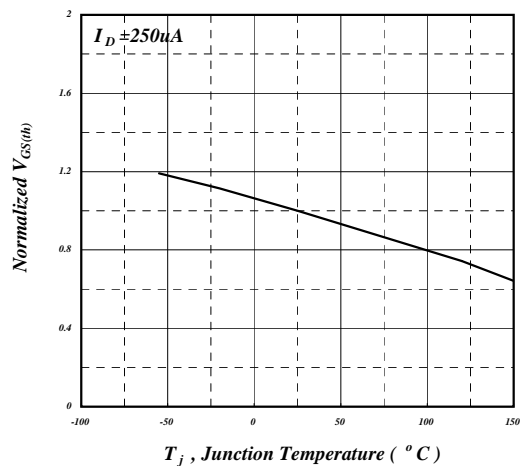

Fig 6. Gate Threshold Voltage v.s. Junction Temperature

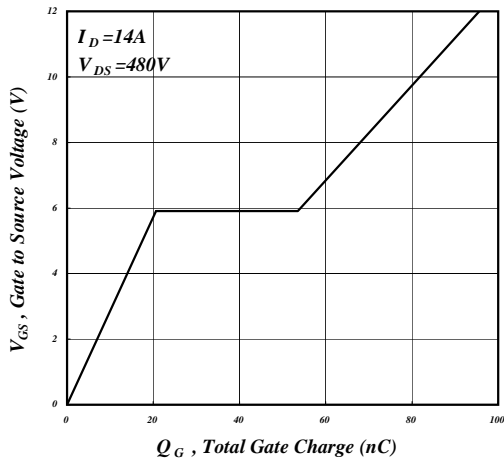

Fig 7. Gate Charge Characteristics

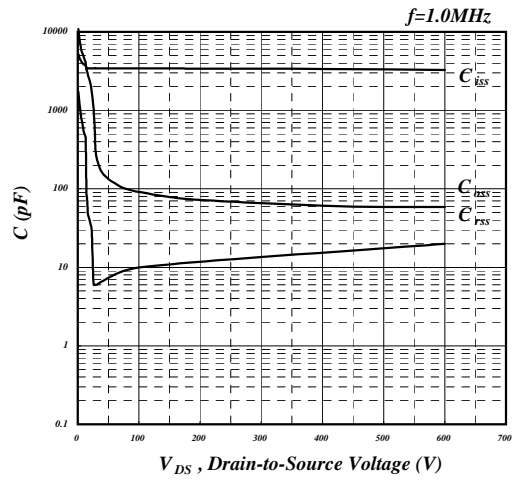

Fig 8. Typical Capacitance Characteristics

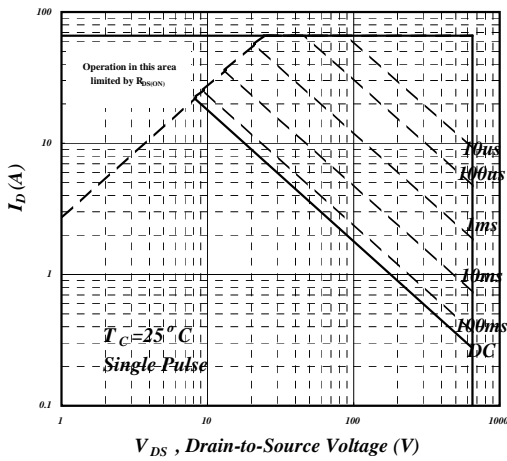

Fig 9. Maximum Safe Operating Area

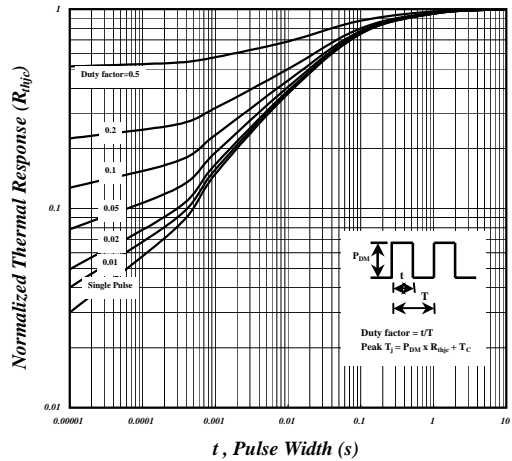

Fig 10. Effective Transient Thermal Impedance

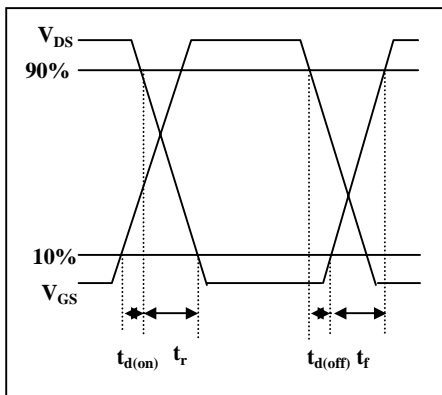

Fig 11. Switching Time Waveform

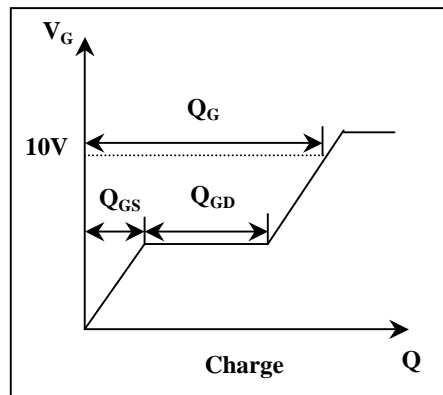

Fig 12. Gate Charge Waveform

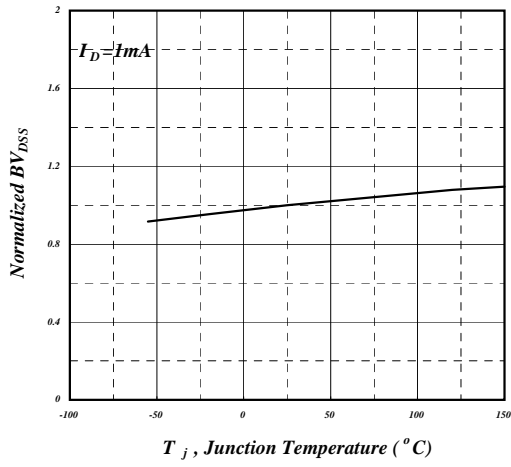

Fig 13. Normalized BV_{DSS} v.s. Junction Temperature

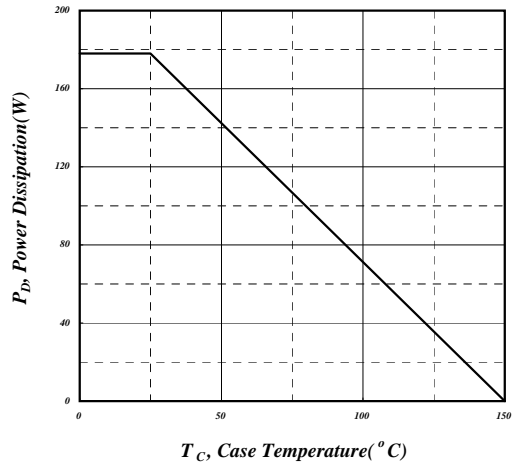

Fig 14. Total Power Dissipation

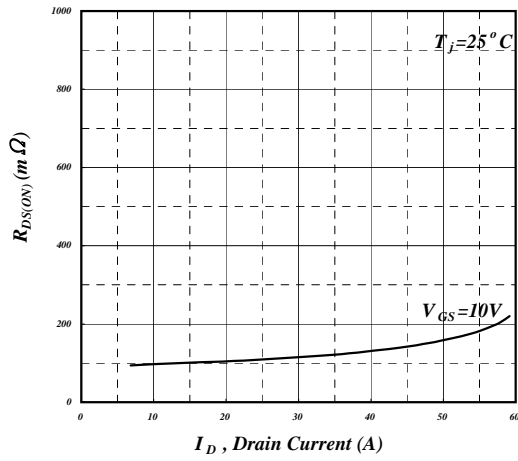
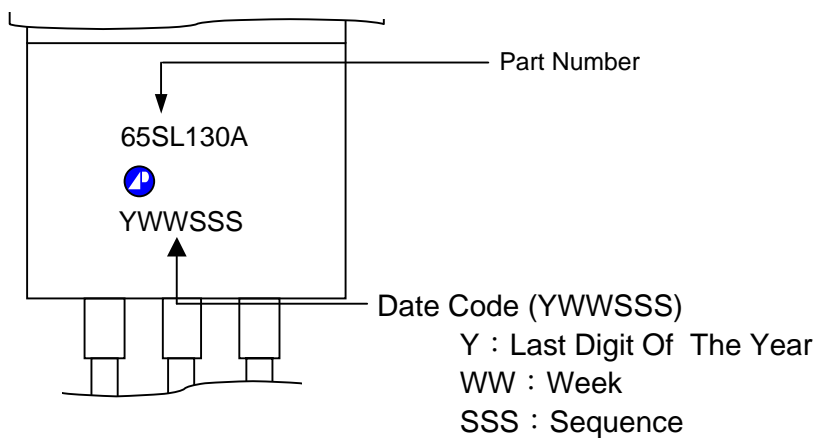

Fig 15. Typ. Drain-Source on State Resistance



AP65SL130AWL

MARKING INFORMATION





Package Outline : TO-247

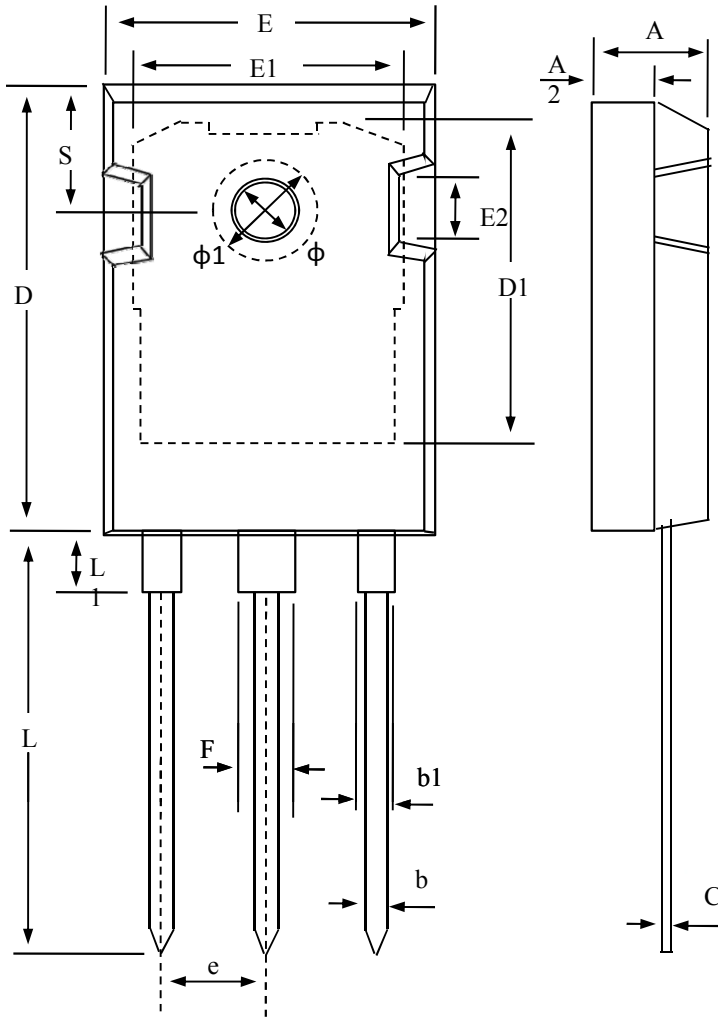

SYMBOLS	Millimeters		
	MIN	NOM	MAX
A	4.80	5.03	5.25
A2	1.90	2.05	2.20
E	15.75	15.95	16.15
E1	13.00	13.60	14.20
E2	3.60	4.35	5.10
D	20.80	20.95	21.10
D1	16.20	16.95	17.70
C	0.50	0.60	0.70
L	19.80	20.10	20.40
L1	4.10	4.25	4.40
F	2.80	3.10	3.40
b	1.05	1.20	1.35
b1	1.90	2.18	2.45
e	5.44 ref.		
ϕ	3.50	3.58	3.65
$\phi 1$	7.18 ref.		
S	6.00	6.15	6.30

1.All Dimensions Are in Millimeters.

2.Dimension Does Not Include Mold Protrusions.



TO-247 FOOTPRINT :

