

AP65SL190DWL

Halogen-Free Product



**Advanced Power
Electronics Corp.**

N-CHANNEL ENHANCEMENT MODE

POWER MOSFET

- ▼ 100% R_g & UIS Test
- ▼ Low t_{rr} / Q_{rr}
- ▼ Simple Drive Requirement
- ▼ RoHS Compliant & Halogen-Free

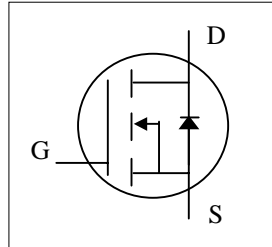

| | |
|-----------------------------|--------|
| BV _{DSS} | 650V |
| R _{DS(ON)} | 0.19 Ω |
| I _D ³ | 20A |

Description

AP65SL190D series are from Advanced Power innovated design and silicon process technology to achieve the lowest possible on-resistance and fast switching performance. It provides the designer with an extreme efficient device for use in a wide range of power applications.

The TO-247 package is widely preferred for commercial-industrial applications. The device is suited for switch mode power supplies, DC-AC converters and high current high speed switching circuits.

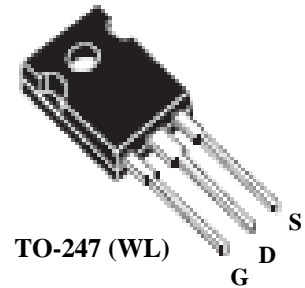

Absolute Maximum Ratings @T_j=25°C (unless otherwise specified)

| Symbol | Parameter | Rating | Units |
|---------------------------------------|--|------------|-------|
| V _{DS} | Drain-Source Voltage | 650 | V |
| V _{GS} | Gate-Source Voltage | ±20 | V |
| V _{GS} | Gate-Source Voltage, AC (f > 1Hz) | ±30 | V |
| I _D @T _C =25°C | Drain Current, V _{GS} @ 10V ³ | 20 | A |
| I _D @T _C =100°C | Drain Current, V _{GS} @ 10V ³ | 12.3 | A |
| I _{DM} | Pulsed Drain Current ¹ | 48 | A |
| dv/dt | MOSFET dv/dt Ruggedness (V _{DS} = 0 ... 400V) | 20 | V/ns |
| P _D @T _C =25°C | Total Power Dissipation | 147 | W |
| P _D @T _A =25°C | Total Power Dissipation | 3.12 | W |
| E _{AS} | Single Pulse Avalanche Energy ⁴ | 300 | mJ |
| dv/dt | Peak Diode Recovery dv/dt ⁵ | 15 | V/ns |
| T _{STG} | Storage Temperature Range | -55 to 150 | °C |
| T _J | Operating Junction Temperature Range | -55 to 150 | °C |

Thermal Data

| Symbol | Parameter | Value | Units |
|--------------------|--|-------|-------|
| R _{thj-c} | Maximum Thermal Resistance, Junction-case | 0.85 | °C/W |
| R _{thj-a} | Maximum Thermal Resistance, Junction-ambient | 40 | °C/W |



AP65SL190DWL

Electrical Characteristics @T_j=25°C(unless otherwise specified)

| Symbol | Parameter | Test Conditions | Min. | Typ. | Max. | Units |
|---------------------|--|--|------|------|------|-------|
| BV _{DSS} | Drain-Source Breakdown Voltage | V _{GS} =0V, I _D =250uA | 650 | - | - | V |
| R _{DS(ON)} | Static Drain-Source On-Resistance ² | V _{GS} =10V, I _D =6.2A | - | - | 0.19 | Ω |
| V _{GS(th)} | Gate Threshold Voltage | V _{DS} =V _{GS} , I _D =250uA | 2 | - | 5 | V |
| g _{fs} | Forward Transconductance | V _{DS} =15V, I _D =7.5A | - | 12 | - | S |
| I _{DSS} | Drain-Source Leakage Current | V _{DS} =520V, V _{GS} =0V | - | - | 100 | uA |
| I _{GSS} | Gate-Source Leakage | V _{GS} =±20V, V _{DS} =0V | - | - | ±1 | uA |
| Q _g | Total Gate Charge | I _D =7.5A | - | 58 | 92.8 | nC |
| Q _{gs} | Gate-Source Charge | V _{DS} =520V | - | 13 | - | nC |
| Q _{gd} | Gate-Drain ("Miller") Charge | V _{GS} =10V | - | 26 | - | nC |
| t _{d(on)} | Turn-on Delay Time | V _{DD} =300V | - | 17 | - | ns |
| t _r | Rise Time | I _D =7.5A | - | 19 | - | ns |
| t _{d(off)} | Turn-off Delay Time | R _G =3.3Ω | - | 57 | - | ns |
| t _f | Fall Time | V _{GS} =10V | - | 16 | - | ns |
| C _{iss} | Input Capacitance | V _{GS} =0V | - | 2070 | 3312 | pF |
| C _{oss} | Output Capacitance | V _{DS} =100V | - | 60 | - | pF |
| C _{rss} | Reverse Transfer Capacitance | f=1.0MHz | - | 5 | - | pF |
| R _g | Gate Resistance | f=1.0MHz | - | 4.1 | 8.2 | Ω |

Source-Drain Diode

| Symbol | Parameter | Test Conditions | Min. | Typ. | Max. | Units |
|-----------------|---------------------------------|---|------|------|------|-------|
| V _{SD} | Forward On Voltage ² | I _S =6.2A, V _{GS} =0V | - | 0.8 | - | V |
| t _{rr} | Reverse Recovery Time | I _S =11A, V _{GS} =0V | - | 155 | - | ns |
| Q _{rr} | Reverse Recovery Charge | di/dt=100A/μs | - | 1.2 | - | μC |

Notes:

- 1.Pulse width limited by max. junction temperature.
- 2.Pulse test
- 3.Limited by max. junction temperature. Maximum duty cycle D=0.75
- 4.Starting T_j=25°C , V_{DD}=50V , L=150mH , R_G=25Ω , V_{GS}=10V
- 5.I_{SD} ≤ I_D, V_{DD} ≤ BV_{DSS}, starting T_J = 25°C

THIS PRODUCT IS SENSITIVE TO ELECTROSTATIC DISCHARGE, PLEASE HANDLE WITH CAUTION.

USE OF THIS PRODUCT AS A CRITICAL COMPONENT IN LIFE SUPPORT OR OTHER SIMILAR SYSTEMS IS NOT AUTHORIZED.

APEC DOES NOT ASSUME ANY LIABILITY ARISING OUT OF THE APPLICATION OR USE OF ANY PRODUCT OR CIRCUIT DESCRIBED HEREIN; NEITHER DOES IT CONVEY ANY LICENSE UNDER ITS PATENT RIGHTS, NOR THE RIGHTS OF OTHERS.

APEC RESERVES THE RIGHT TO MAKE CHANGES WITHOUT FURTHER NOTICE TO ANY PRODUCTS HEREIN TO IMPROVE RELIABILITY, FUNCTION OR DESIGN.

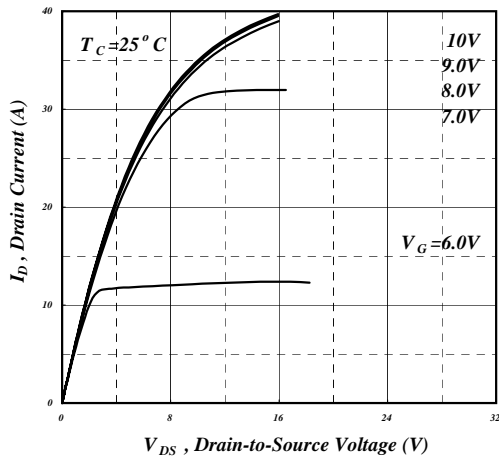

Fig 1. Typical Output Characteristics

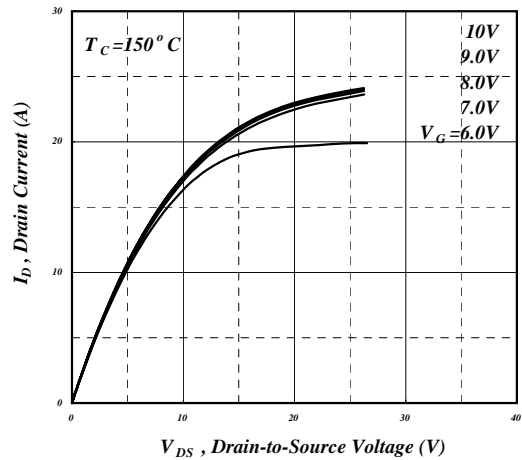

Fig 2. Typical Output Characteristics

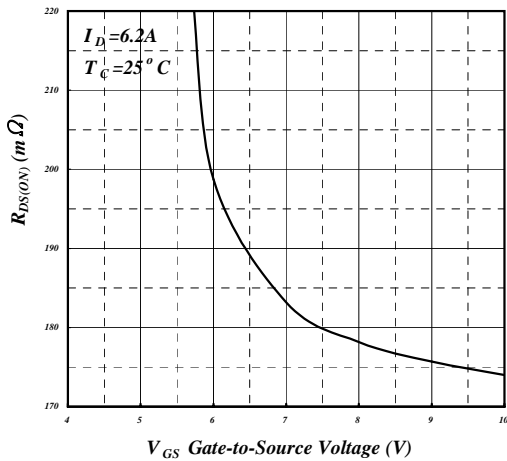

Fig 3. On-Resistance v.s. Gate Voltage

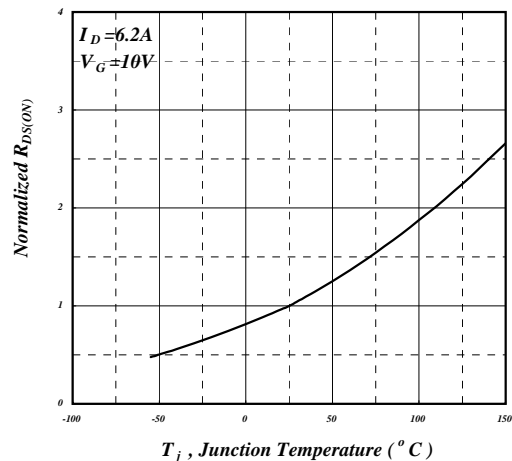

Fig 4. Normalized On-Resistance v.s. Junction Temperature

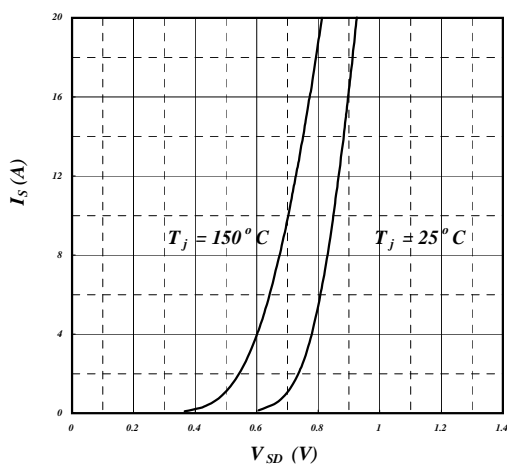

Fig 5. Forward Characteristic of Reverse Diode

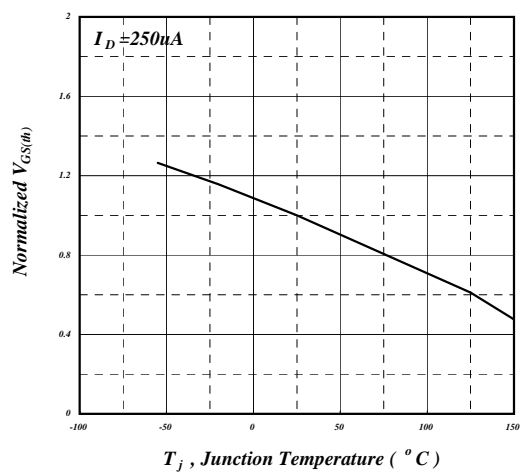

Fig 6. Gate Threshold Voltage v.s. Junction Temperature

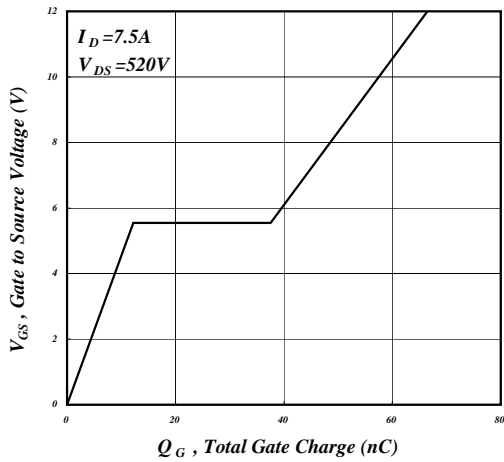

Fig 7. Gate Charge Characteristics

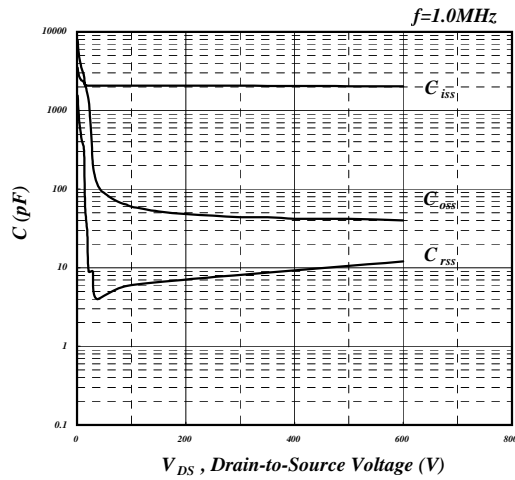

Fig 8. Typical Capacitance Characteristics

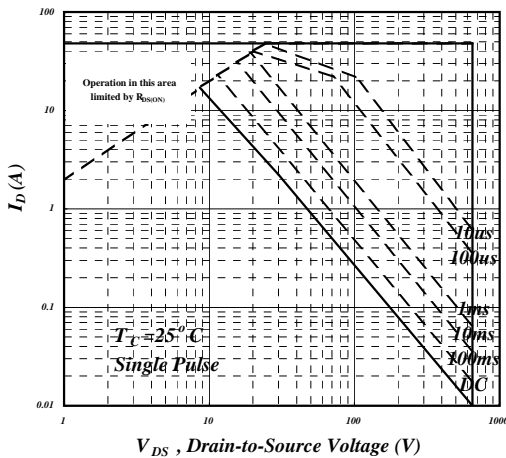

Fig 9. Maximum Safe Operating Area

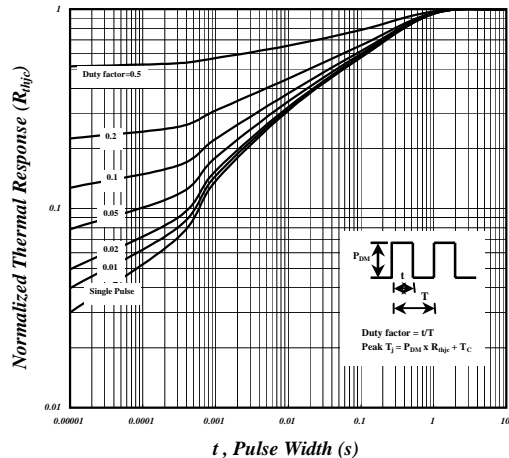

Fig 10. Effective Transient Thermal Impedance



Fig 11. Switching Time Waveform

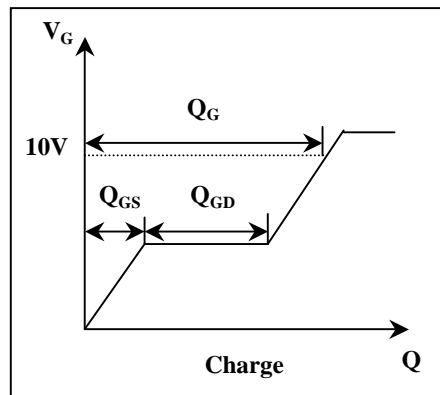

Fig 12. Gate Charge Waveform

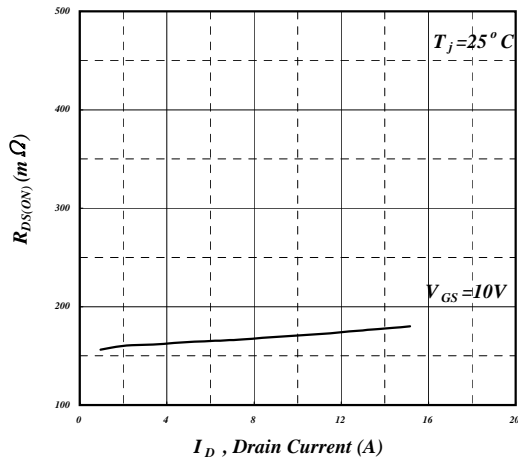

Fig 13. Typ. Drain-Source on State Resistance

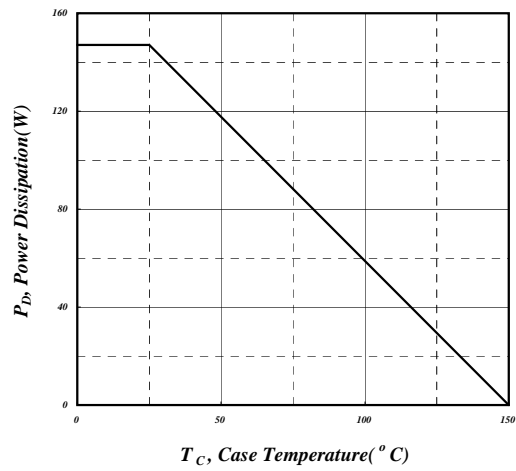
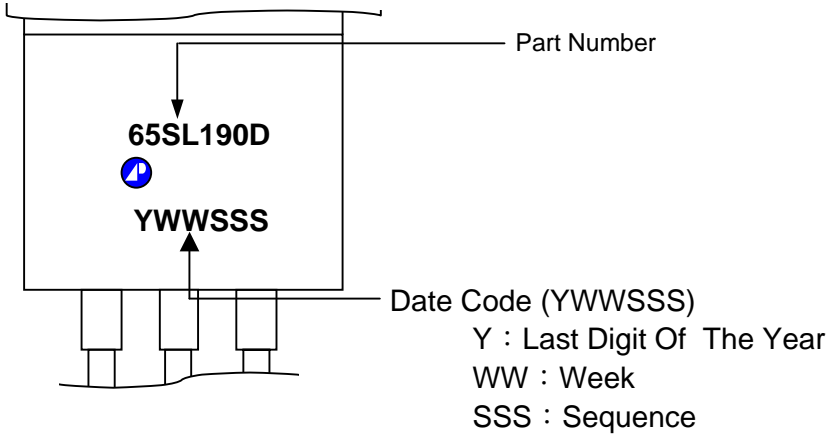

Fig 14. Total Power Dissipation



AP65SL190DWL

MARKING INFORMATION





Package Outline : TO-247

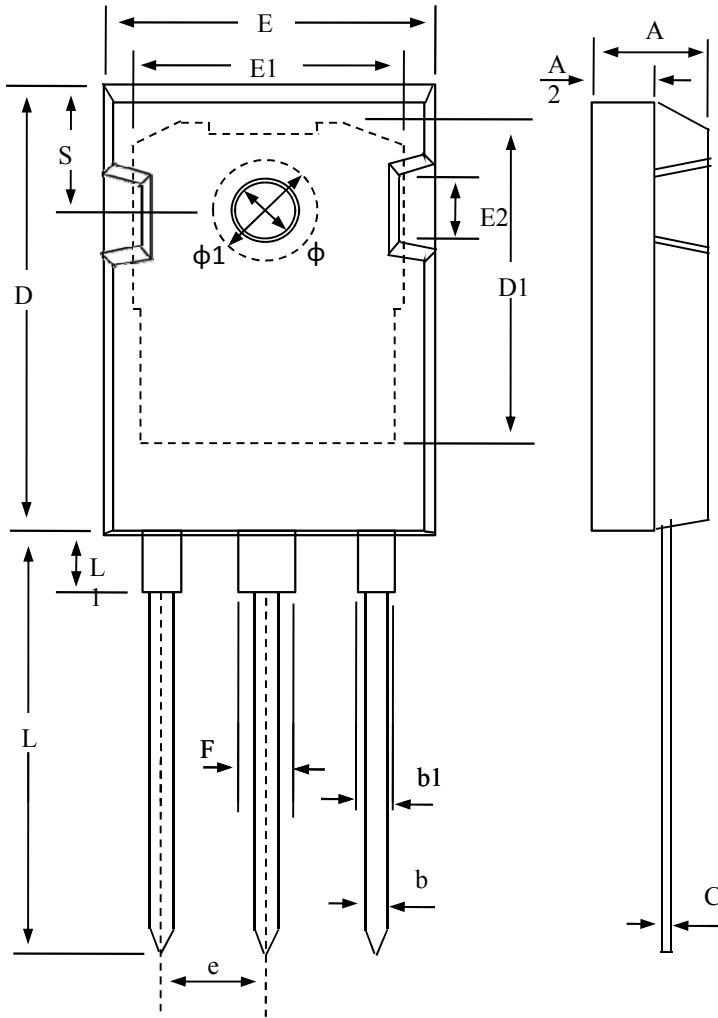

| SYMBOLS | Millimeters | | |
|---------|-------------|-------|-------|
| | MIN | NOM | MAX |
| A | 4.80 | 5.03 | 5.25 |
| A2 | 1.90 | 2.05 | 2.20 |
| E | 15.75 | 15.95 | 16.15 |
| E1 | 13.00 | 13.60 | 14.20 |
| E2 | 3.60 | 4.35 | 5.10 |
| D | 20.80 | 20.95 | 21.10 |
| D1 | 16.20 | 16.95 | 17.70 |
| C | 0.50 | 0.60 | 0.70 |
| L | 19.80 | 20.10 | 20.40 |
| L1 | 4.10 | 4.25 | 4.40 |
| F | 2.80 | 3.10 | 3.40 |
| b | 1.05 | 1.20 | 1.35 |
| b1 | 1.90 | 2.18 | 2.45 |
| e | 5.44 ref. | | |
| φ | 3.50 | 3.58 | 3.65 |
| φ1 | 7.18 ref. | | |
| S | 6.00 | 6.15 | 6.30 |

1.All Dimensions Are in Millimeters.

2.Dimension Does Not Include Mold Protrusions.



TO-247 FOOTPRINT :

