

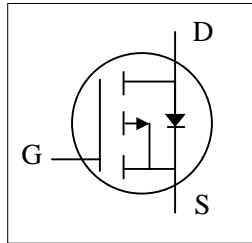

- ▼ Lower On-resistance
- ▼ Simple Drive Requirement
- ▼ Fast Switching Characteristic
- ▼ RoHS Compliant & Halogen-Free



BV_{DSS}	-40V
$R_{DS(ON)}$	13.5m Ω
I_D	-65A

Description

AP6679 series are from Advanced Power innovated design and silicon process technology to achieve the lowest possible on-resistance and fast switching performance. It provides the designer with an extreme efficient device for use in a wide range of power applications.

The TO-263 package is widely preferred for all commercial-industrial surface mount applications using infrared reflow technique and suited for high current application due to the low connection resistance. The through-hole version (AP6679GP-A) are available for low-profile applications.

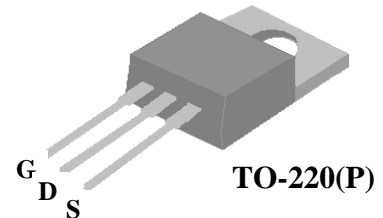
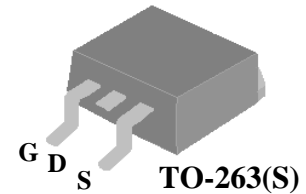

Absolute Maximum Ratings @ $T_j=25^\circ\text{C}$ (unless otherwise specified)

Symbol	Parameter	Rating	Units
V_{DS}	Drain-Source Voltage	-40	V
V_{GS}	Gate-Source Voltage	± 25	V
$I_D @ T_C=25^\circ\text{C}$	Drain Current, $V_{GS} @ 10\text{V}$	-65	A
$I_D @ T_C=100^\circ\text{C}$	Drain Current, $V_{GS} @ 10\text{V}$	-41	A
I_{DM}	Pulsed Drain Current ¹	-260	A
$P_D @ T_C=25^\circ\text{C}$	Total Power Dissipation	89	W
	Linear Derating Factor	0.71	W/ $^\circ\text{C}$
T_{STG}	Storage Temperature Range	-55 to 150	$^\circ\text{C}$
T_J	Operating Junction Temperature Range	-55 to 150	$^\circ\text{C}$

Thermal Data

Symbol	Parameter	Value	Unit
Rthj-c	Maximum Thermal Resistance, Junction-case	1.4	$^\circ\text{C}/\text{W}$
Rthj-a	Maximum Thermal Resistance, Junction-ambient	62	$^\circ\text{C}/\text{W}$



AP6679GS/P-A-HF

Electrical Characteristics @T_j=25°C(unless otherwise specified)

Symbol	Parameter	Test Conditions	Min.	Typ.	Max.	Units
BV _{DSS}	Drain-Source Breakdown Voltage	V _{GS} =0V, I _D =-250uA	-40	-	-	V
ΔBV _{DSS} /ΔT _j	Breakdown Voltage Temperature Coefficient	Reference to 25°C, I _D =-1mA	-	-0.02	-	V/°C
R _{DS(ON)}	Static Drain-Source On-Resistance ²	V _{GS} =-10V, I _D =-28A	-	-	13.5	mΩ
		V _{GS} =-4.5V, I _D =-20A	-	-	20	mΩ
V _{GS(th)}	Gate Threshold Voltage	V _{DS} =V _{GS} , I _D =-250uA	-0.8	-	-2.5	V
g _{fs}	Forward Transconductance	V _{DS} =-10V, I _D =-24A	-	24	-	S
I _{DSS}	Drain-Source Leakage Current	V _{DS} =-40V, V _{GS} =0V	-	-	-1	uA
	Drain-Source Leakage Current (T _j =125°C)	V _{DS} =-32V, V _{GS} =0V	-	-	-250	uA
I _{GSS}	Gate-Source Leakage	V _{GS} = ±25V, V _{DS} =0V	-	-	±100	nA
Q _g	Total Gate Charge	I _D =-16A	-	43	70	nC
Q _{gs}	Gate-Source Charge	V _{DS} =-32V	-	7	-	nC
Q _{gd}	Gate-Drain ("Miller") Charge	V _{GS} =-4.5V	-	26	-	nC
t _{d(on)}	Turn-on Delay Time	V _{DS} =-20V	-	11	-	ns
t _r	Rise Time	I _D =-16A	-	40	-	ns
t _{d(off)}	Turn-off Delay Time	R _G =3.3Ω, V _{GS} =-10V	-	50	-	ns
t _f	Fall Time	R _D =0.8Ω	-	80	-	ns
C _{iss}	Input Capacitance	V _{GS} =0V	-	2870	4590	pF
C _{oss}	Output Capacitance	V _{DS} =-25V	-	960	-	pF
C _{rss}	Reverse Transfer Capacitance	f=1.0MHz	-	740	-	pF
R _g	Gate Resistance	f=1.0MHz	-	2.5	3.75	Ω

Source-Drain Diode

Symbol	Parameter	Test Conditions	Min.	Typ.	Max.	Units
V _{SD}	Forward On Voltage ²	I _S =-20A, V _{GS} =0V	-	-	-1.2	V
t _{rr}	Reverse Recovery Time	I _S =-16A, V _{GS} =0V,	-	37	-	ns
Q _{rr}	Reverse Recovery Charge	di/dt=-100A/μs	-	42	-	nC

Notes:

- 1.Pulse width limited by Max. junction temperature.
- 2.Pulse test

THIS PRODUCT IS SENSITIVE TO ELECTROSTATIC DISCHARGE, PLEASE HANDLE WITH CAUTION.

USE OF THIS PRODUCT AS A CRITICAL COMPONENT IN LIFE SUPPORT OR OTHER SIMILAR SYSTEMS IS NOT AUTHORIZED.

APEC DOES NOT ASSUME ANY LIABILITY ARISING OUT OF THE APPLICATION OR USE OF ANY PRODUCT OR CIRCUIT DESCRIBED HEREIN; NEITHER DOES IT CONVEY ANY LICENSE UNDER ITS PATENT RIGHTS, NOR THE RIGHTS OF OTHERS.

APEC RESERVES THE RIGHT TO MAKE CHANGES WITHOUT FURTHER NOTICE TO ANY PRODUCTS HEREIN TO IMPROVE RELIABILITY, FUNCTION OR DESIGN.

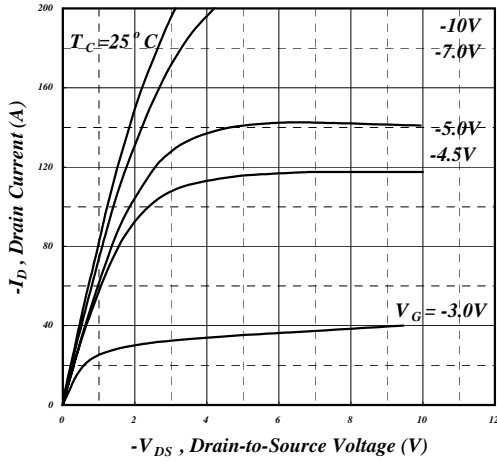

Fig 1. Typical Output Characteristics

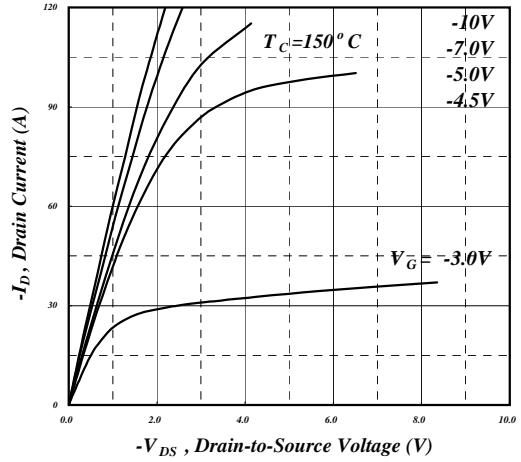

Fig 2. Typical Output Characteristics

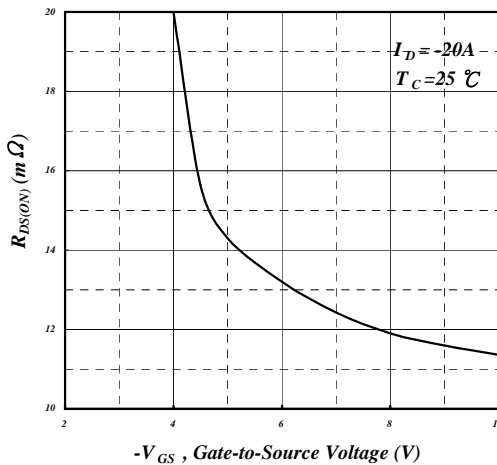

Fig 3. On-Resistance v.s. Gate Voltage

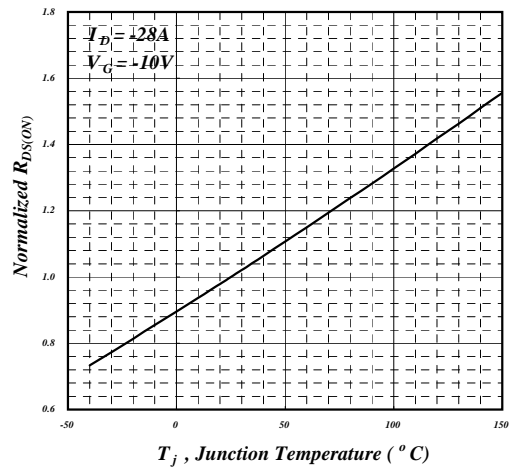

Fig 4. Normalized On-Resistance v.s. Junction Temperature

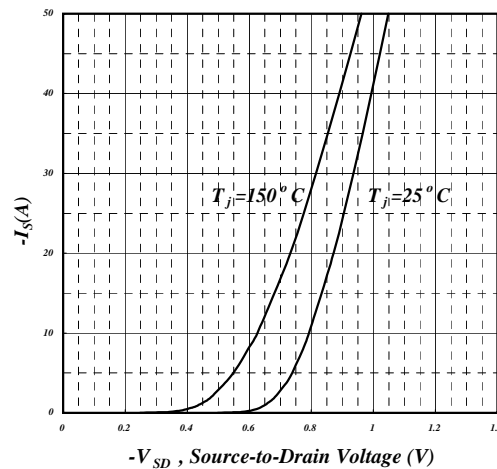

Fig 5. Forward Characteristic of Reverse Diode

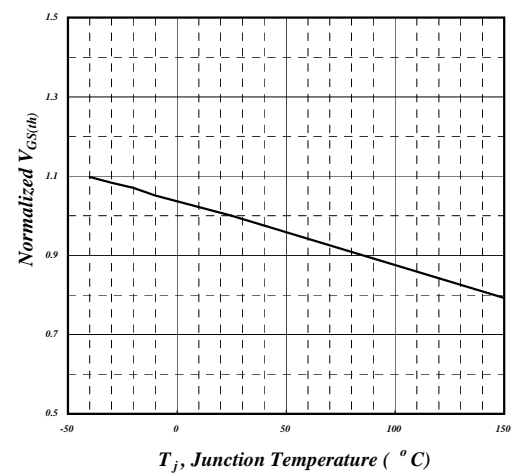

Fig 6. Gate Threshold Voltage v.s. Junction Temperature

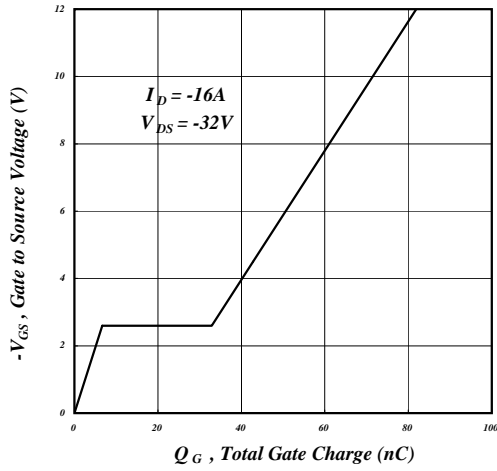

Fig 7. Gate Charge Characteristics

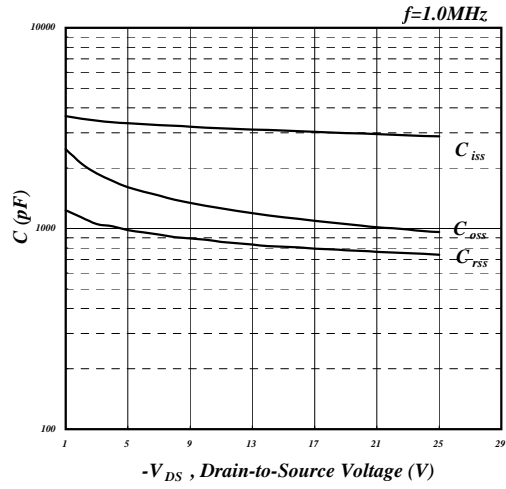

Fig 8. Typical Capacitance Characteristics

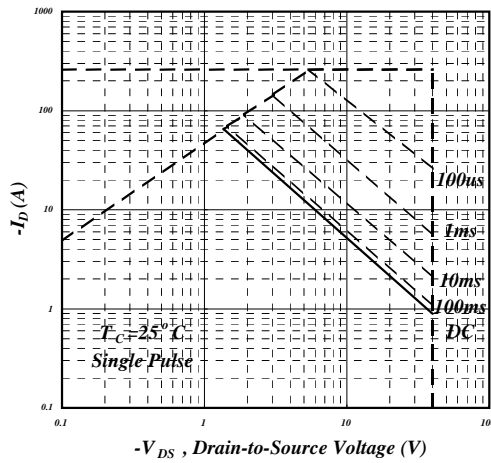

Fig 9. Maximum Safe Operating Area

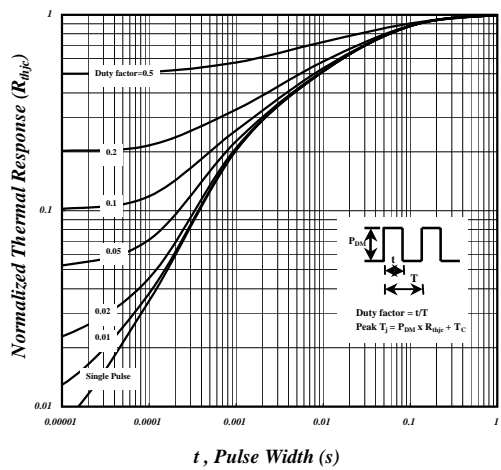

Fig 10. Effective Transient Thermal Impedance

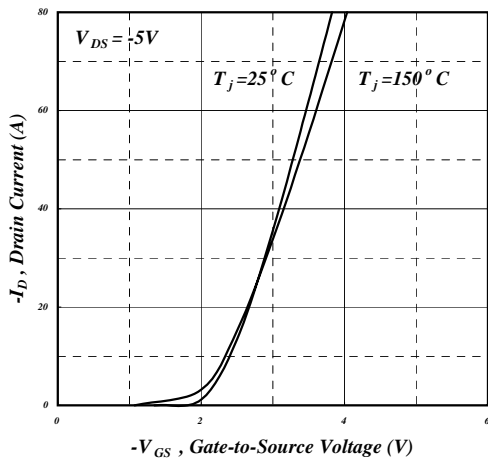

Fig 11. Transfer Characteristics

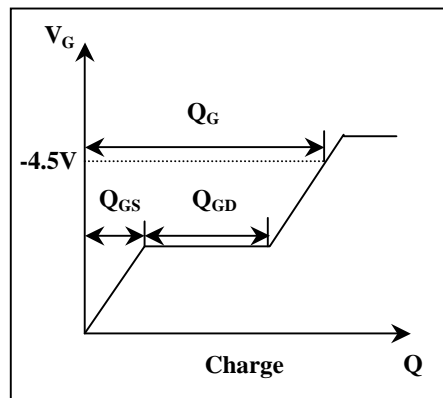
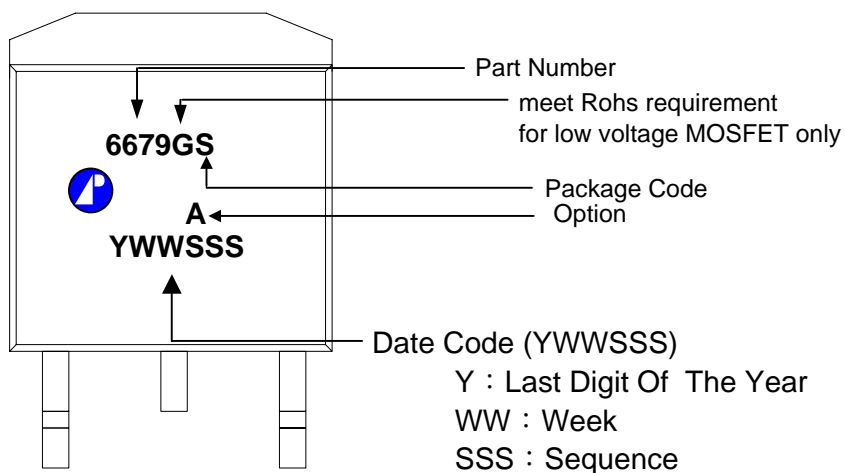

Fig 12. Gate Charge Waveform



MARKING INFORMATION

TO-263



TO-220

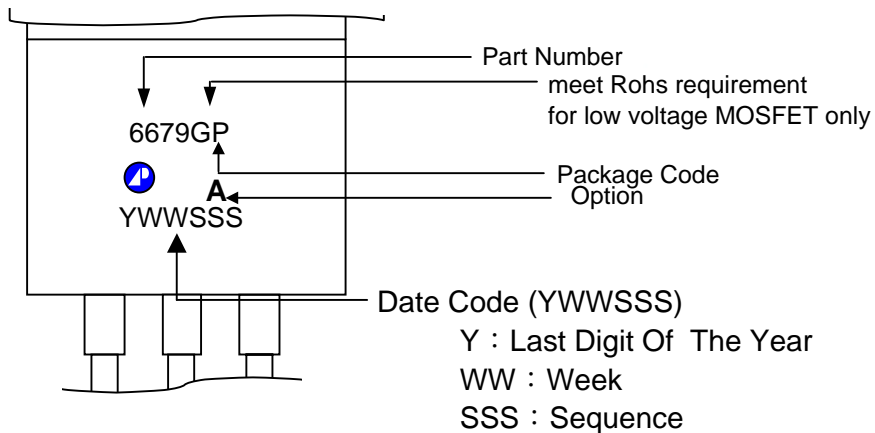



TO-263 FOOTPRINT :

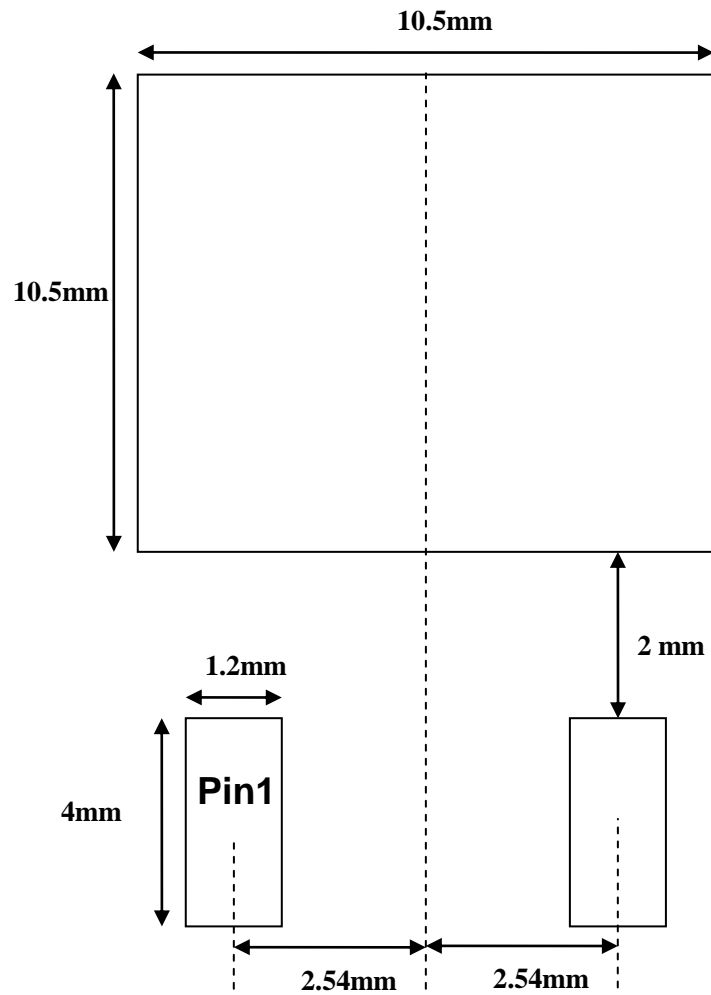



Package Outline : TO-263

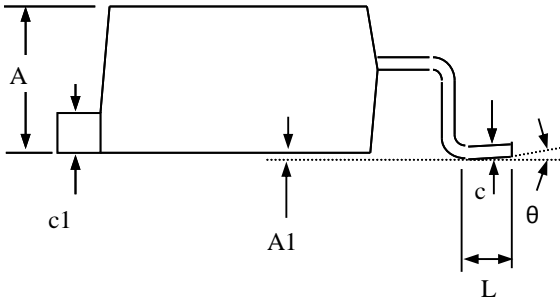
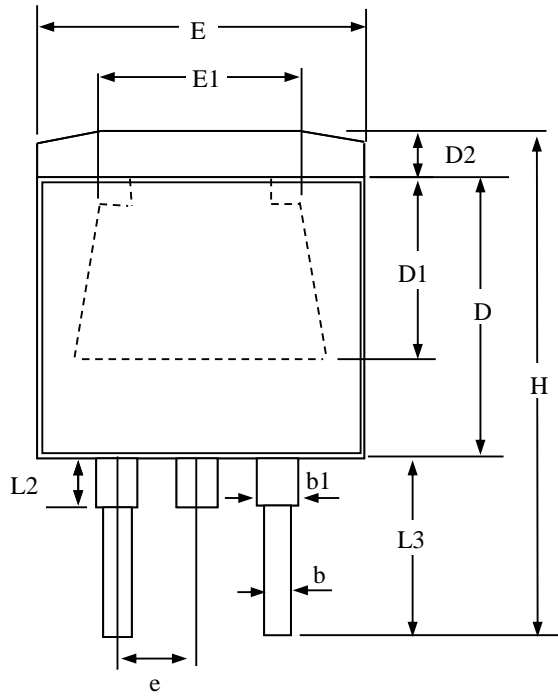

SYMBOLS	Millimeters		
	MIN	NOM	MAX
A	4.00	4.75	5.20
A1	0.00	0.15	0.30
b	0.50	0.90	1.10
b1	1.07	1.27	1.47
c	0.30	0.55	0.80
c1	1.10	1.40	1.70
D	8.30	9.05	9.80
D1	5.10(ref)		
D2	1.27(ref)		
E	9.50	10.10	10.70
E1	7.00~9.00(ref)		
e	2.04	2.54	3.04
L1	2.54(ref)		
L2	1.5 (ref)		
L3	3.50	4.50	5.50
θ	0°	-----	8°
H	13.07	15.27	16.57

- 1.All Dimensions Are in Millimeters.
- 2.Dimension Does Not Include Mold Protrusions.