

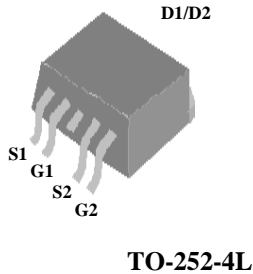

- ▼ Simple Drive Requirement
- ▼ Good Thermal Performance
- ▼ Fast Switching Performance
- ▼ RoHS Compliant & Halogen-Free



N-CH	$BV_{DSS}$	60V
	$R_{DS(ON)}$	36m $\Omega$
	$I_D^3$	12A
P-CH	$BV_{DSS}$	-60V
	$R_{DS(ON)}$	75m $\Omega$
	$I_D^3$	-12A

**Description**

Advanced Power MOSFETs from APEC provide the designer with the best combination of fast switching, ruggedized device design, low on-resistance and cost-effectiveness.

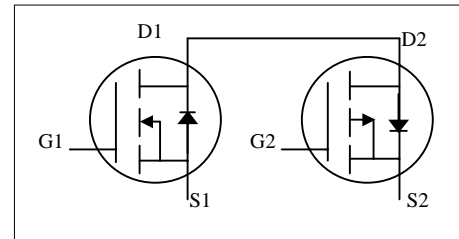

**Absolute Maximum Ratings @ $T_J=25^\circ\text{C}$ (unless otherwise specified)**

Symbol	Parameter	Rating		Units
		N-channel	P-channel	
$V_{DS}$	Drain-Source Voltage	60	-60	V
$V_{GS}$	Gate-Source Voltage	+20	+20	V
$I_D@T_C=25^\circ\text{C}$	Drain Current, $V_{GS} @ 10V^3$	12	-12	A
$I_D@T_C=100^\circ\text{C}$	Drain Current, $V_{GS} @ 10V^3$	9.4	-8.5	A
$I_{DM}$	Pulsed Drain Current <sup>1</sup>	30	-30	A
$P_D@T_C=25^\circ\text{C}$	Total Power Dissipation	25		W
$P_D@T_A=25^\circ\text{C}$	Total Power Dissipation <sup>4</sup>	3.13		W
$T_{STG}$	Storage Temperature Range	-55 to 150		$^\circ\text{C}$
$T_J$	Operating Junction Temperature Range	-55 to 150		$^\circ\text{C}$

**Thermal Data**

Symbol	Parameter	Value	Unit
Rthj-c	Maximum Thermal Resistance, Junction-case	5	$^\circ\text{C}/\text{W}$
Rthj-a	Maximum Thermal Resistance, Junction-ambient <sup>3</sup>	40	$^\circ\text{C}/\text{W}$



# AP6C036H

## N-CH Electrical Characteristics @ $T_j=25^\circ\text{C}$ (unless otherwise specified)

Symbol	Parameter	Test Conditions	Min.	Typ.	Max.	Units
$BV_{DSS}$	Drain-Source Breakdown Voltage	$V_{GS}=0V, I_D=250\mu A$	60	-	-	V
$R_{DS(ON)}$	Static Drain-Source On-Resistance <sup>2</sup>	$V_{GS}=10V, I_D=6A$	-	-	36	$m\Omega$
		$V_{GS}=4.5V, I_D=4A$	-	-	42	$m\Omega$
$V_{GS(th)}$	Gate Threshold Voltage	$V_{DS}=V_{GS}, I_D=250\mu A$	1	-	3	V
$g_{fs}$	Forward Transconductance	$V_{DS}=10V, I_D=6A$	-	25	-	S
$I_{DSS}$	Drain-Source Leakage Current	$V_{DS}=48V, V_{GS}=0V$	-	-	25	$\mu A$
$I_{GSS}$	Gate-Source Leakage	$V_{GS}=\pm 20V, V_{DS}=0V$	-	-	$\pm 100$	nA
$Q_g$	Total Gate Charge	$I_D=4A$	-	15	24	nC
$Q_{gs}$	Gate-Source Charge	$V_{DS}=48V$	-	5	-	nC
$Q_{gd}$	Gate-Drain ("Miller") Charge	$V_{GS}=4.5V$	-	6	-	nC
$t_{d(on)}$	Turn-on Delay Time	$V_{DS}=30V$	-	8	-	ns
$t_r$	Rise Time	$I_D=6A$	-	12	-	ns
$t_{d(off)}$	Turn-off Delay Time	$R_G=3.3\Omega$	-	24	-	ns
$t_f$	Fall Time	$V_{GS}=10V$	-	5	-	ns
$C_{iss}$	Input Capacitance	$V_{GS}=0V$	-	1670	2672	pF
$C_{oss}$	Output Capacitance	$V_{DS}=25V$	-	105	-	pF
$C_{rss}$	Reverse Transfer Capacitance	$f=1.0\text{MHz}$	-	65	-	pF

## Source-Drain Diode

Symbol	Parameter	Test Conditions	Min.	Typ.	Max.	Units
$V_{SD}$	Forward On Voltage <sup>2</sup>	$I_S=2.4A, V_{GS}=0V$	-	-	1.3	V
$t_{rr}$	Reverse Recovery Time	$I_S=6A, V_{GS}=0V$	-	19	-	ns
$Q_{rr}$	Reverse Recovery Charge	$dI/dt=100A/\mu s$	-	14	-	nC



**P-CH Electrical Characteristics @T<sub>j</sub>=25°C(unless otherwise specified)**

Symbol	Parameter	Test Conditions	Min.	Typ.	Max.	Units
BV <sub>DSS</sub>	Drain-Source Breakdown Voltage	V <sub>GS</sub> =0V, I <sub>D</sub> =-250uA	-60	-	-	V
R <sub>DS(ON)</sub>	Static Drain-Source On-Resistance <sup>2</sup>	V <sub>GS</sub> =-10V, I <sub>D</sub> =-4A	-	-	75	mΩ
		V <sub>GS</sub> =-4.5V, I <sub>D</sub> =-3A	-	-	90	mΩ
V <sub>GS(th)</sub>	Gate Threshold Voltage	V <sub>DS</sub> =V <sub>GS</sub> , I <sub>D</sub> =-250uA	-1	-	-3	V
g <sub>fs</sub>	Forward Transconductance	V <sub>DS</sub> =-10V, I <sub>D</sub> =-4A	-	14	-	S
I <sub>DSS</sub>	Drain-Source Leakage Current	V <sub>DS</sub> =-48V, V <sub>GS</sub> =0V	-	-	-25	uA
I <sub>GSS</sub>	Gate-Source Leakage	V <sub>GS</sub> =±20V, V <sub>DS</sub> =0V	-	-	±100	nA
Q <sub>g</sub>	Total Gate Charge	I <sub>D</sub> =-3A	-	15	24	nC
Q <sub>gs</sub>	Gate-Source Charge	V <sub>DS</sub> =-48V	-	4.5	-	nC
Q <sub>gd</sub>	Gate-Drain ("Miller") Charge	V <sub>GS</sub> =-4.5V	-	5.5	-	nC
t <sub>d(on)</sub>	Turn-on Delay Time	V <sub>DS</sub> =-30V	-	10	-	ns
t <sub>r</sub>	Rise Time	I <sub>D</sub> =-4A	-	12	-	ns
t <sub>d(off)</sub>	Turn-off Delay Time	R <sub>G</sub> =3.3Ω	-	38	-	ns
t <sub>f</sub>	Fall Time	V <sub>GS</sub> =-10V	-	24	-	ns
C <sub>iss</sub>	Input Capacitance	V <sub>GS</sub> =0V	-	1700	2720	pF
C <sub>oss</sub>	Output Capacitance	V <sub>DS</sub> =-25V	-	120	-	pF
C <sub>rss</sub>	Reverse Transfer Capacitance	f=1.0MHz	-	75	-	pF

**Source-Drain Diode**

Symbol	Parameter	Test Conditions	Min.	Typ.	Max.	Units
V <sub>SD</sub>	Forward On Voltage <sup>2</sup>	I <sub>S</sub> =-2.4A, V <sub>GS</sub> =0V	-	-	-1.3	V
t <sub>rr</sub>	Reverse Recovery Time	I <sub>S</sub> =-4A, V <sub>GS</sub> =0V	-	20	-	ns
Q <sub>rr</sub>	Reverse Recovery Charge	dI/dt=-100A/μs	-	15	-	nC

**Notes:**

- 1.Pulse width limited by Max. junction temperature.
- 2.Pulse test.
- 3.Package bond wires limited.
- 4.N-CH , P-CH are same , mounted on 1 in<sup>2</sup> 2oz FR4 board t ≤ 10s.

THIS PRODUCT IS SENSITIVE TO ELECTROSTATIC DISCHARGE, PLEASE HANDLE WITH CAUTION.

USE OF THIS PRODUCT AS A CRITICAL COMPONENT IN LIFE SUPPORT OR OTHER SIMILAR SYSTEMS IS NOT AUTHORIZED.

APEC DOES NOT ASSUME ANY LIABILITY ARISING OUT OF THE APPLICATION OR USE OF ANY PRODUCT OR CIRCUIT DESCRIBED HEREIN; NEITHER DOES IT CONVEY ANY LICENSE UNDER ITS PATENT RIGHTS, NOR THE RIGHTS OF OTHERS.

APEC RESERVES THE RIGHT TO MAKE CHANGES WITHOUT FURTHER NOTICE TO ANY PRODUCTS HEREIN TO IMPROVE RELIABILITY, FUNCTION OR DESIGN.



## N-Channel

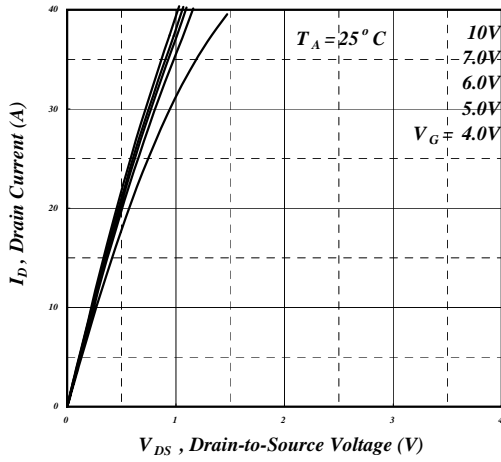

**Fig 1. Typical Output Characteristics**

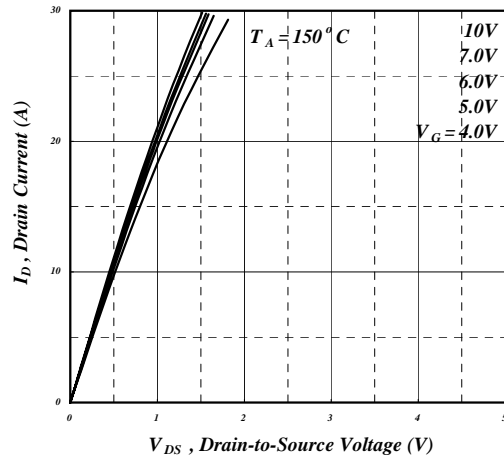

**Fig 2. Typical Output Characteristics**

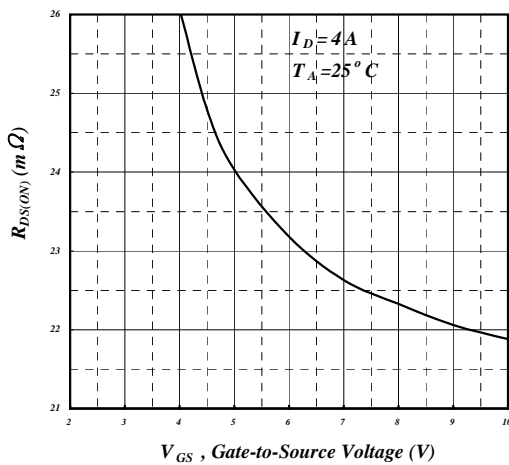

**Fig 3. On-Resistance v.s. Gate Voltage**

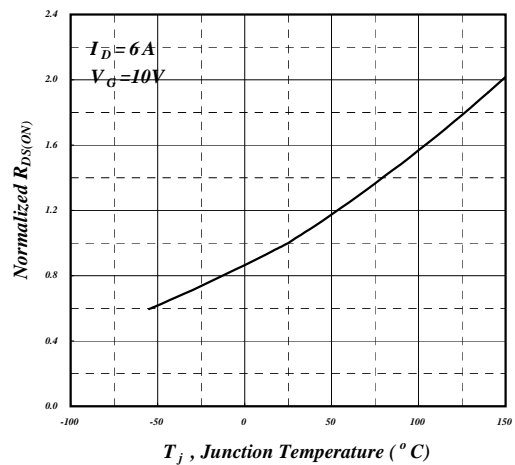

**Fig 4. Normalized On-Resistance v.s. Junction Temperature**

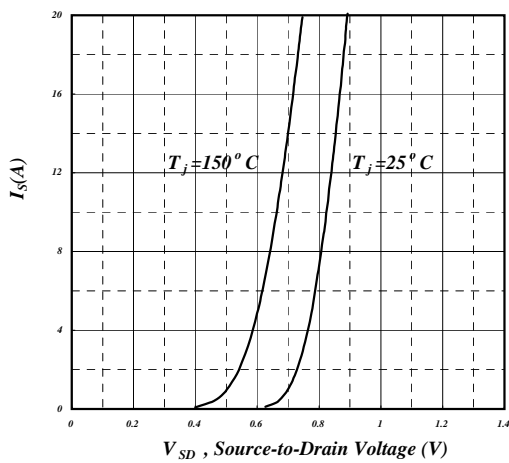

**Fig 5. Forward Characteristic of Reverse Diode**

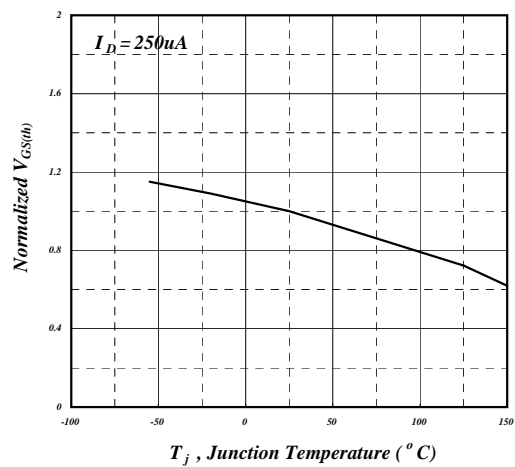

**Fig 6. Gate Threshold Voltage v.s. Junction Temperature**



N-Channel

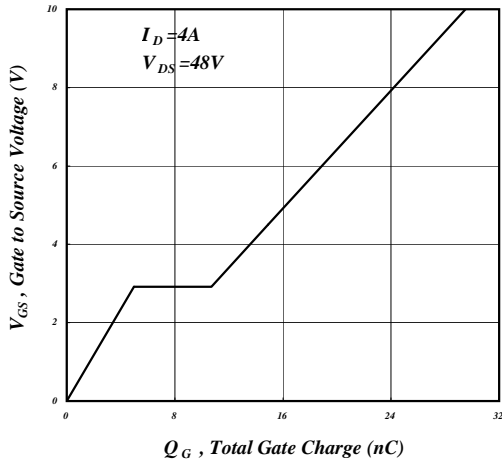

Fig 7. Gate Charge Characteristics

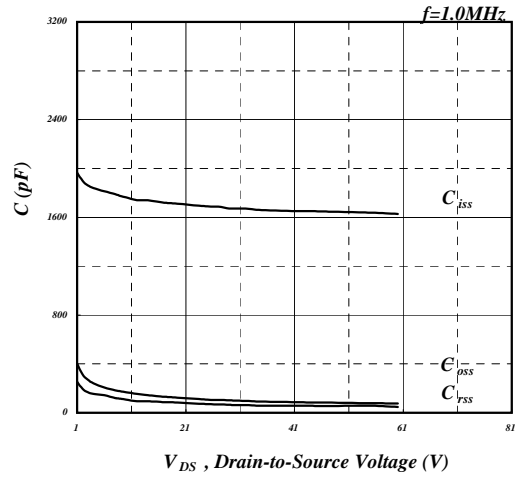

Fig 8. Typical Capacitance Characteristics

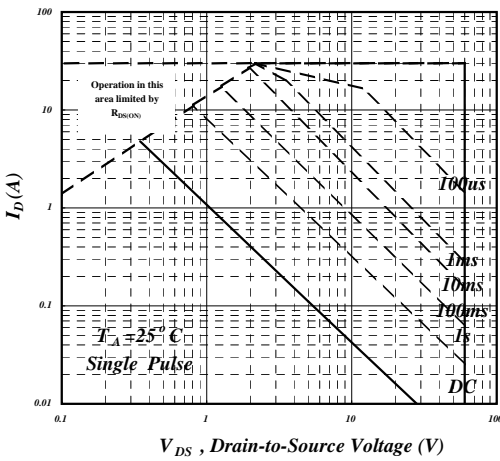

Fig 9. Maximum Safe Operating Area

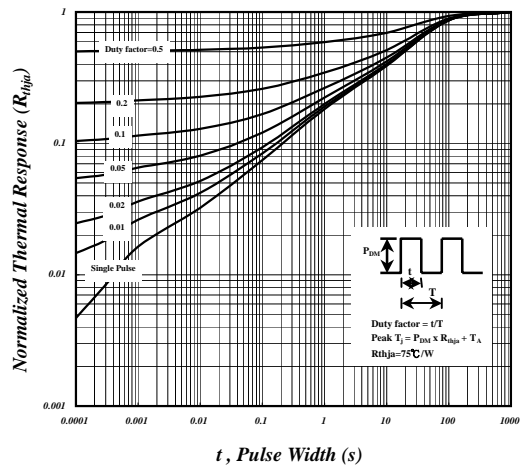

Fig 10. Effective Transient Thermal Impedance

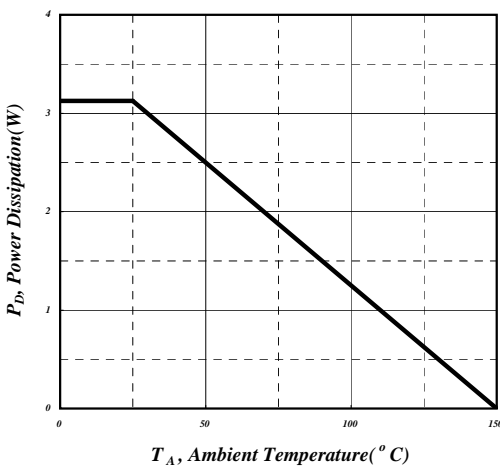

Fig 11. Total Power Dissipation

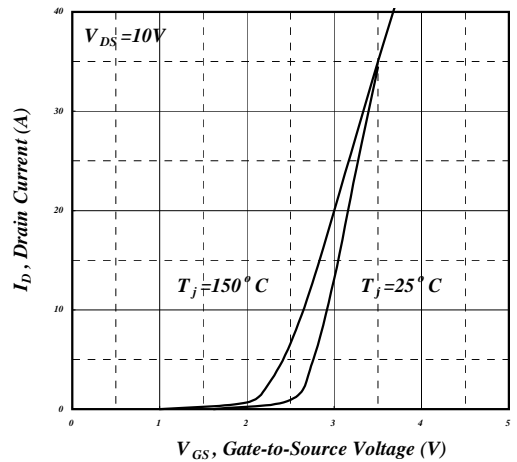

Fig 12. Transfer Characteristics



# AP6C036H

## P-Channel

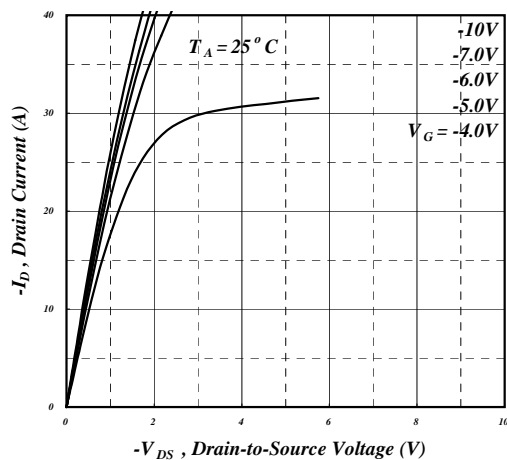

Fig 1. Typical Output Characteristics

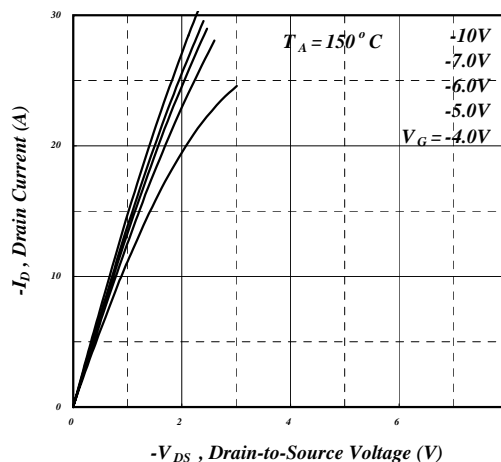

Fig 2. Typical Output Characteristics

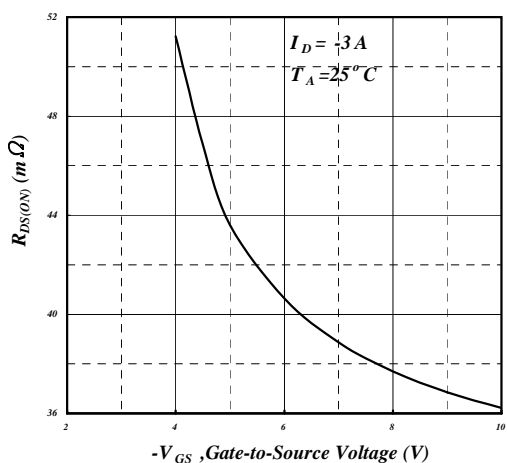

Fig 3. On-Resistance v.s. Gate Voltage

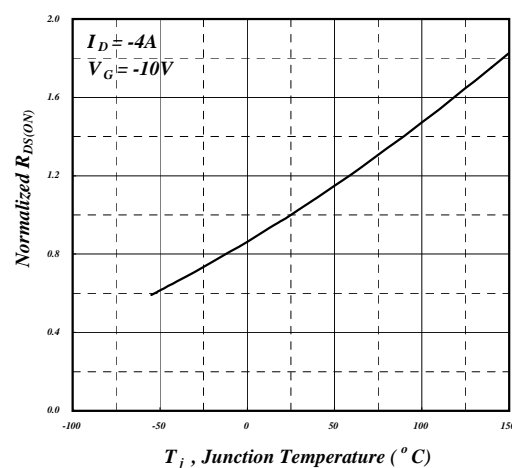

Fig 4. Normalized On-Resistance v.s. Junction Temperature

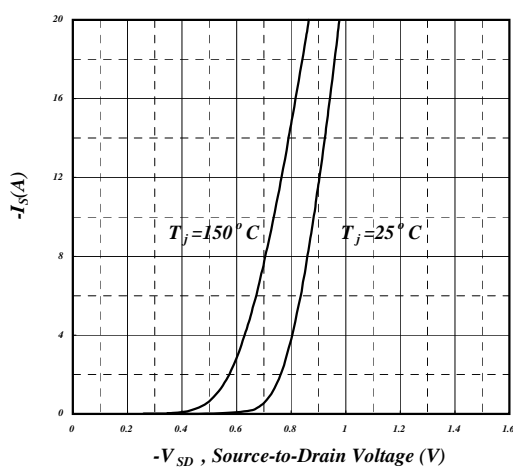

Fig 5. Forward Characteristic of Reverse Diode

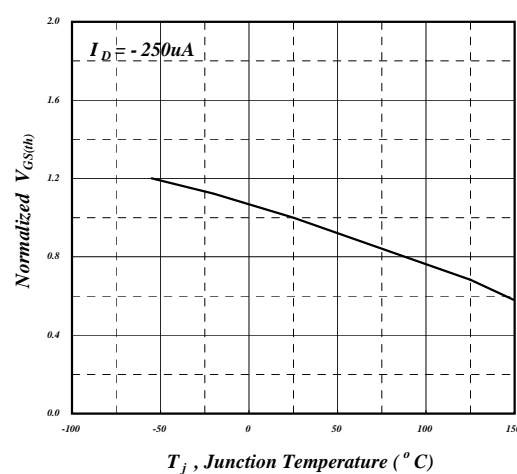

Fig 6. Gate Threshold Voltage v.s. Junction Temperature



P-Channel

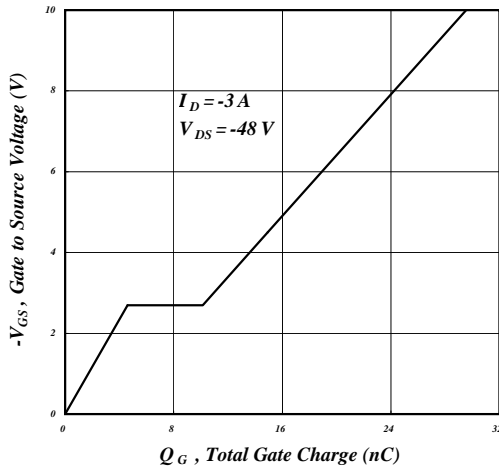

Fig 7. Gate Charge Characteristics

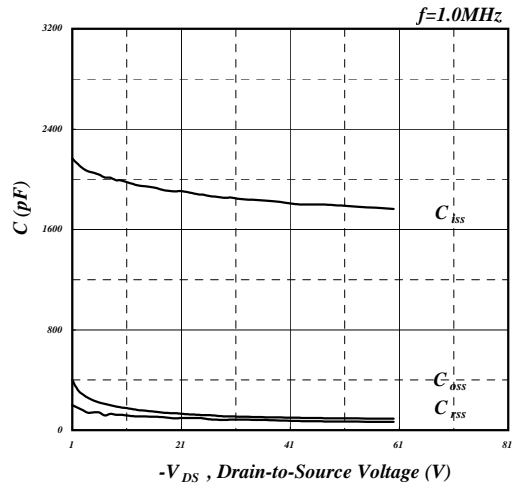

Fig 8. Typical Capacitance Characteristics

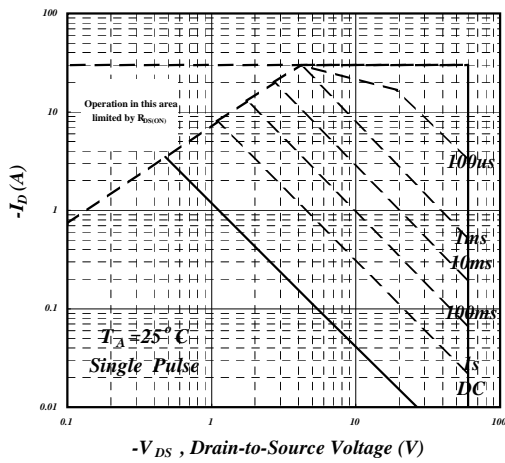

Fig 9. Maximum Safe Operating Area

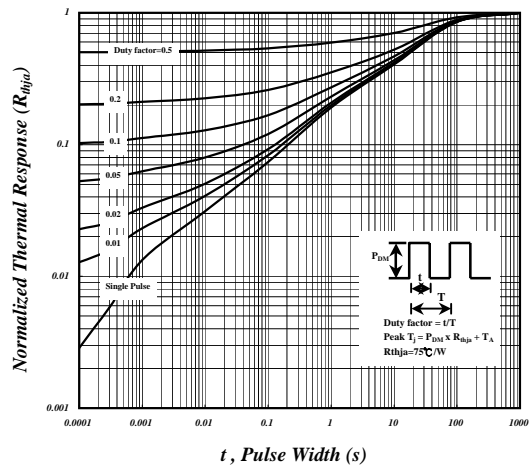

Fig 10. Effective Transient Thermal Impedance

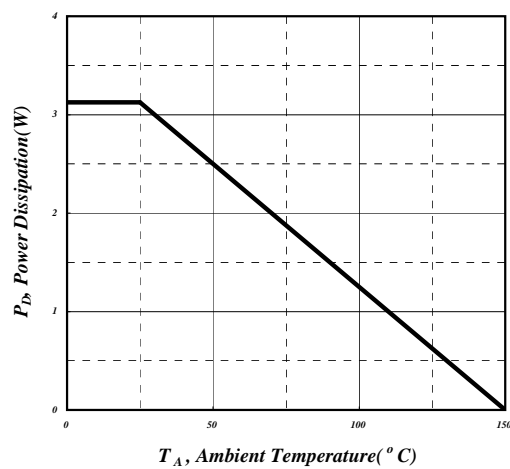

Fig 11. Total Power Dissipation

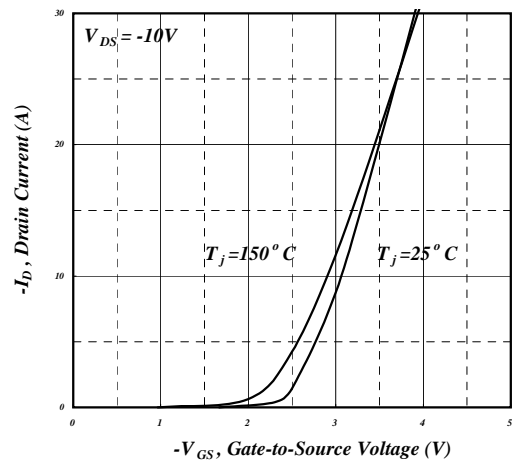

Fig 12. Transfer Characteristics



# AP6C036H

## MARKING INFORMATION

---

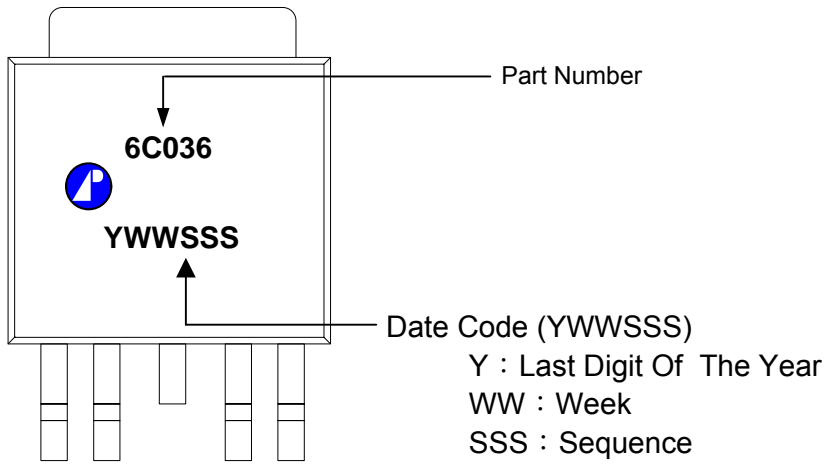





## Package Outline : TO-252-4L

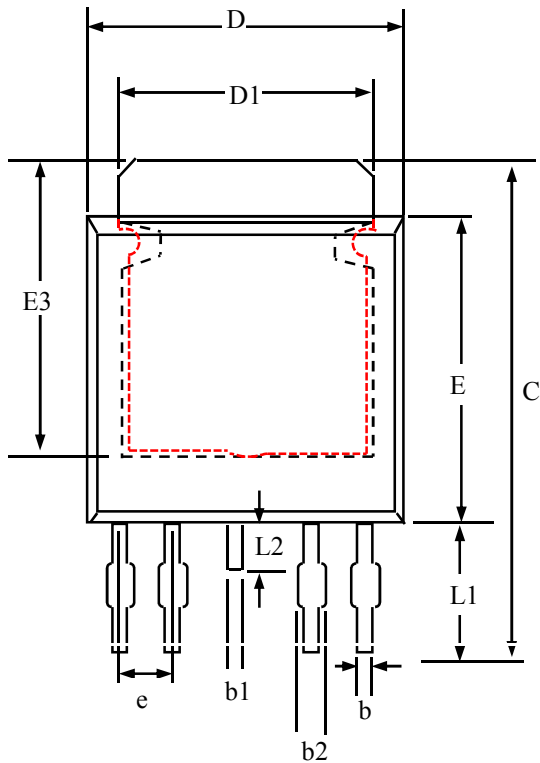

SYMBOLS	Millimeters		
	MIN	NOM	MAX
D	6.30	6.55	6.80
D1	4.80	5.35	5.90
C	9.30	9.90	10.50
E	5.30	5.80	6.30
E3	4.50	5.15	5.80
L	0.90	1.35	1.80
L1	2.00	2.53	3.05
L2	0.50	0.85	1.20
b	0.30	0.50	0.70
b1	0.40	0.60	0.80
A	2.10	2.30	2.50
A2	0.40	0.53	0.65
A1	0.00	0.10	0.20
e	1.20	1.30	1.40
b2	0.50	0.65	0.80

- 1.All Dimensions Are in Millimeters.
- 2.Dimension Does Not Include Mold Protrusions.

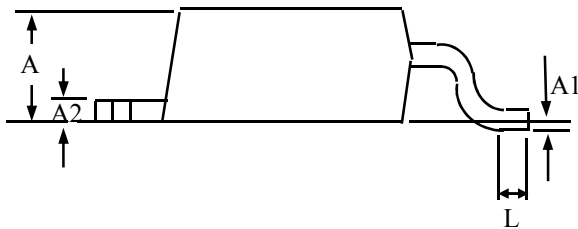



TO-252(4L) FOOTPRINT :

