

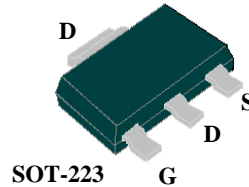

- ▼ Simple Drive Requirement
- ▼ Lower Gate Charge
- ▼ Fast Switching Characteristic
- ▼ RoHS Compliant & Halogen-Free



BV_{DSS}	60V
$R_{DS(ON)}$	90m Ω
I_D^3	4.1A

Description

AP6N090 series are from Advanced Power innovated design and silicon process technology to achieve the lowest possible on-resistance and fast switching performance. It provides the designer with an extreme efficient device for use in a wide range of power applications.

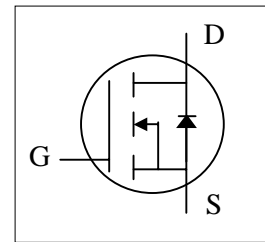

The SOT-223 package is designed for surface mount application, larger heatsink than SO-8 and SOT package.

Absolute Maximum Ratings @ $T_J=25^\circ\text{C}$ (unless otherwise specified)

Symbol	Parameter	Rating	Units
V_{DS}	Drain-Source Voltage	60	V
V_{GS}	Gate-Source Voltage	+20	V
$I_D @ T_A=25^\circ\text{C}$	Drain Current, $V_{GS} @ 10V^3$	4.1	A
$I_D @ T_A=70^\circ\text{C}$	Drain Current, $V_{GS} @ 10V^3$	3.2	A
I_{DM}	Pulsed Drain Current ¹	20	A
$P_D @ T_A=25^\circ\text{C}$	Total Power Dissipation	2.78	W
T_{STG}	Storage Temperature Range	-55 to 150	$^\circ\text{C}$
T_J	Operating Junction Temperature Range	-55 to 150	$^\circ\text{C}$

Thermal Data

Symbol	Parameter	Value	Unit
Rthj-a	Maximum Thermal Resistance, Junction-ambient ³	45	$^\circ\text{C}/\text{W}$



AP6N090K

Electrical Characteristics @T_j=25°C(unless otherwise specified)

Symbol	Parameter	Test Conditions	Min.	Typ.	Max.	Units
BV _{DSS}	Drain-Source Breakdown Voltage	V _{GS} =0V, I _D =250uA	60	-	-	V
R _{DS(ON)}	Static Drain-Source On-Resistance ²	V _{GS} =10V, I _D =2.5A	-	-	90	mΩ
		V _{GS} =4.5V, I _D =1.5A	-	-	120	mΩ
V _{GS(th)}	Gate Threshold Voltage	V _{DS} =V _{GS} , I _D =250uA	1	-	3	V
g _{fs}	Forward Transconductance	V _{DS} =5V, I _D =3A	-	9	-	S
I _{DSS}	Drain-Source Leakage Current	V _{DS} =48V, V _{GS} =0V	-	-	25	uA
I _{GSS}	Gate-Source Leakage	V _{GS} =±20V, V _{DS} =0V	-	-	±100	nA
Q _g	Total Gate Charge	I _D =3A	-	10	16	nC
Q _{gs}	Gate-Source Charge	V _{DS} =48V	-	1.5	-	nC
Q _{gd}	Gate-Drain ("Miller") Charge	V _{GS} =10V	-	2	-	nC
t _{d(on)}	Turn-on Delay Time	V _{DS} =30V	-	5	-	ns
t _r	Rise Time	I _D =1A	-	7	-	ns
t _{d(off)}	Turn-off Delay Time	R _G =3.3Ω	-	15	-	ns
t _f	Fall Time	V _{GS} =10V	-	3	-	ns
C _{iss}	Input Capacitance	V _{GS} =0V	-	420	672	pF
C _{oss}	Output Capacitance	V _{DS} =30V	-	35	-	pF
C _{rss}	Reverse Transfer Capacitance	f=1.0MHz	-	25	-	pF

Source-Drain Diode

Symbol	Parameter	Test Conditions	Min.	Typ.	Max.	Units
V _{SD}	Forward On Voltage ²	I _S =1.2A, V _{GS} =0V	-	-	1.3	V
t _{rr}	Reverse Recovery Time	I _S =3A, V _{GS} =0V,	-	11	-	ns
Q _{rr}	Reverse Recovery Charge	dI/dt=100A/μs	-	6	-	nC

Notes:

- 1.Pulse width limited by Max. junction temperature.
- 2.Pulse test
- 3.Surface mounted on 1 in² copper pad of FR4 board, t ≤10sec ; 120 °C/W when mounted on Min. copper pad.

THIS PRODUCT IS SENSITIVE TO ELECTROSTATIC DISCHARGE, PLEASE HANDLE WITH CAUTION.

USE OF THIS PRODUCT AS A CRITICAL COMPONENT IN LIFE SUPPORT OR OTHER SIMILAR SYSTEMS IS NOT AUTHORIZED.

APEC DOES NOT ASSUME ANY LIABILITY ARISING OUT OF THE APPLICATION OR USE OF ANY PRODUCT OR CIRCUIT DESCRIBED HEREIN; NEITHER DOES IT CONVEY ANY LICENSE UNDER ITS PATENT RIGHTS, NOR THE RIGHTS OF OTHERS.

APEC RESERVES THE RIGHT TO MAKE CHANGES WITHOUT FURTHER NOTICE TO ANY PRODUCTS HEREIN TO IMPROVE RELIABILITY, FUNCTION OR DESIGN.

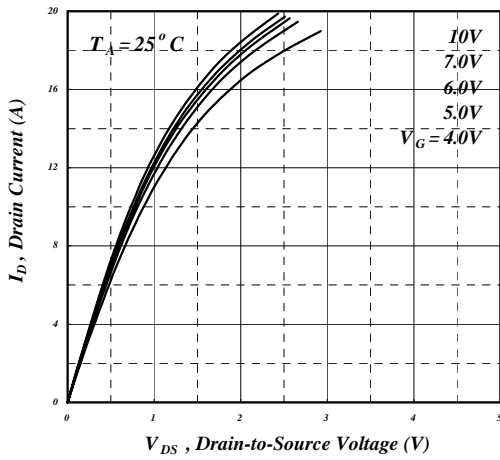

Fig 1. Typical Output Characteristics

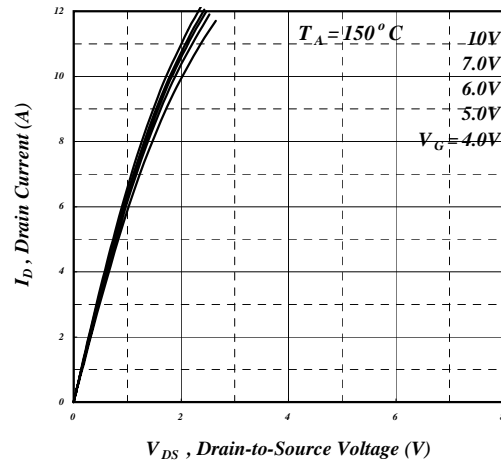

Fig 2. Typical Output Characteristics

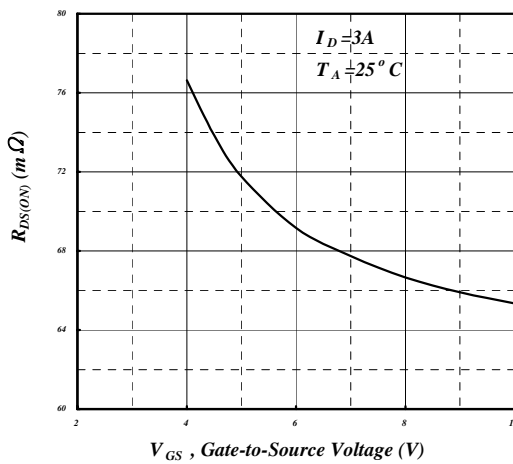

Fig 3. On-Resistance v.s. Gate Voltage

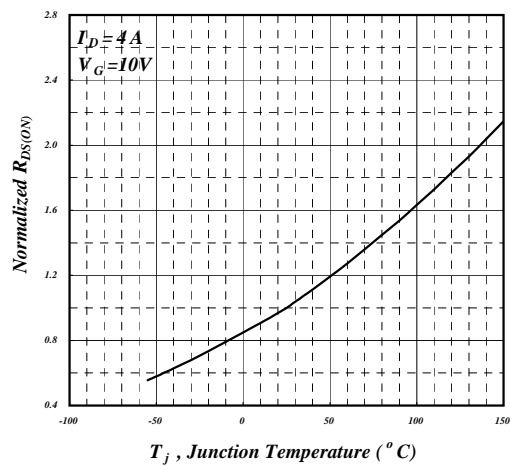

Fig 4. Normalized On-Resistance v.s. Junction Temperature

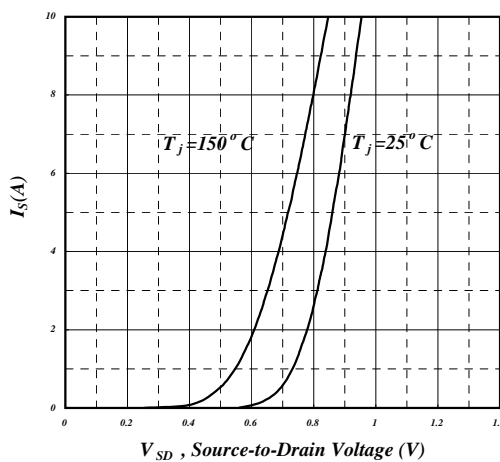

Fig 5. Forward Characteristic of Reverse Diode

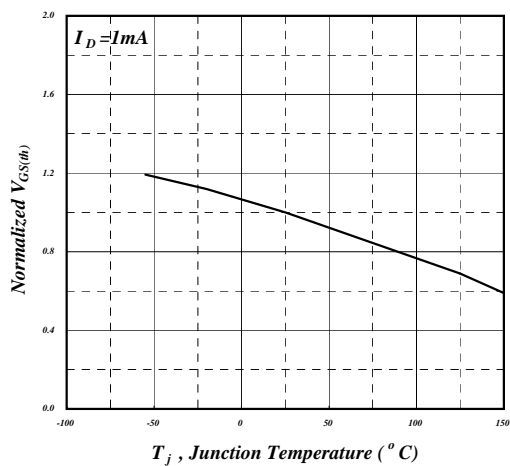

Fig 6. Gate Threshold Voltage v.s. Junction Temperature

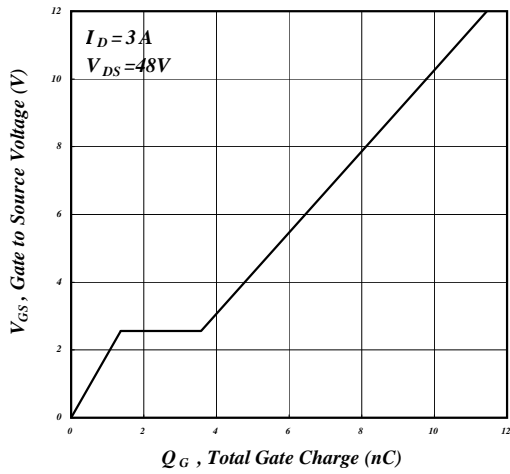

Fig 7. Gate Charge Characteristics

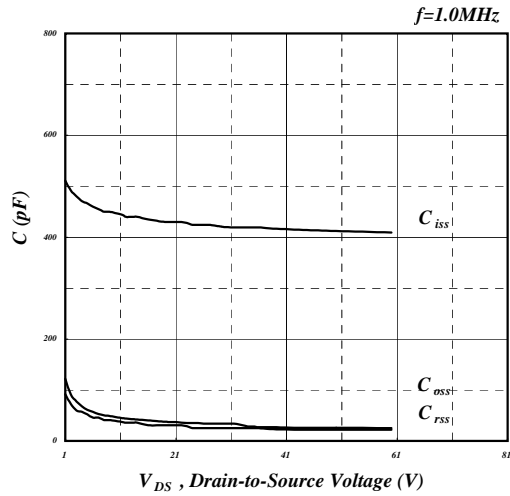

Fig 8. Typical Capacitance Characteristics

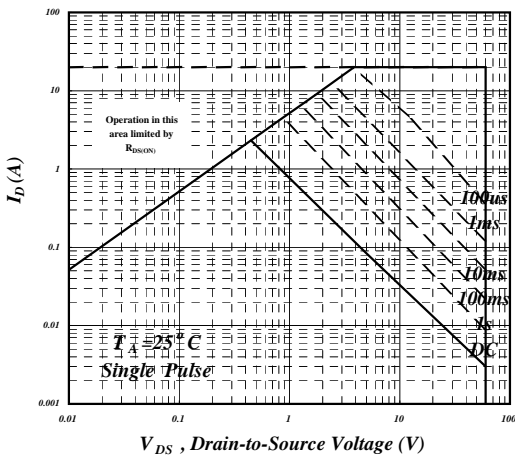

Fig 9. Maximum Safe Operating Area

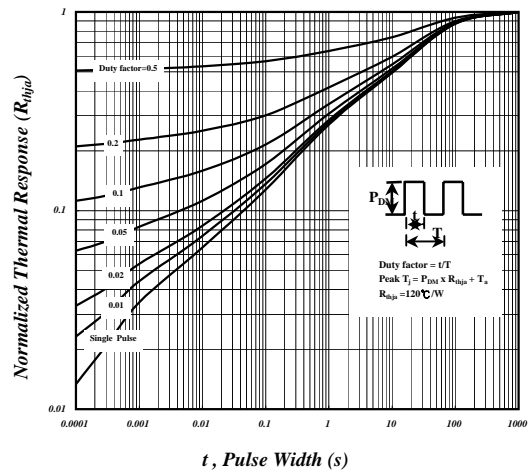

Fig 10. Effective Transient Thermal Impedance

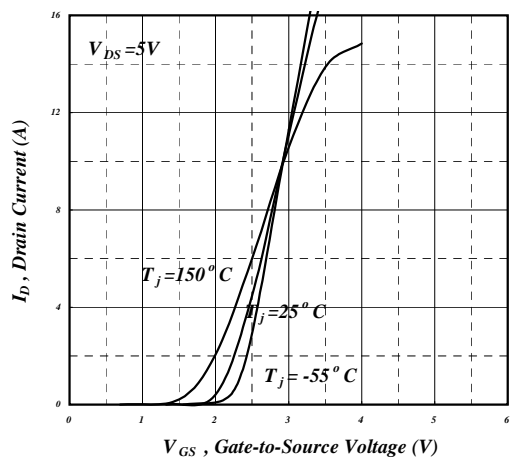

Fig 11. Transfer Characteristics

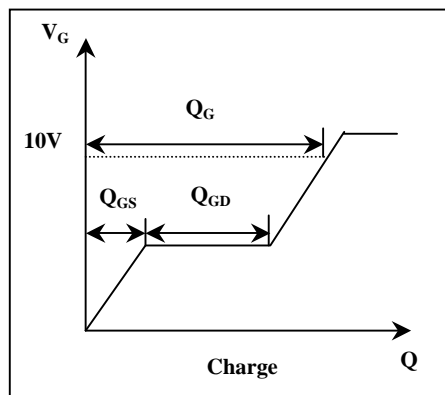

Fig 12. Gate Charge Waveform

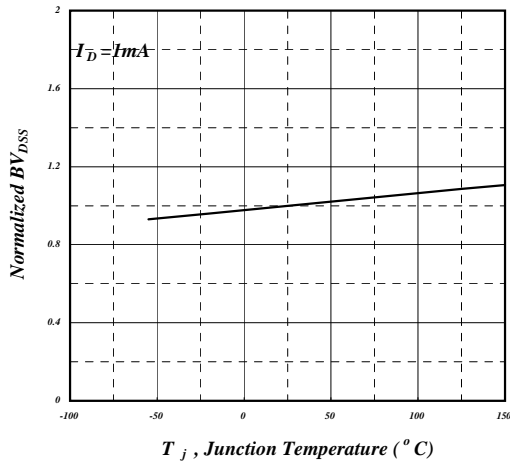

Fig 13. Normalized BV_{DSS} v.s. Junction Temperature

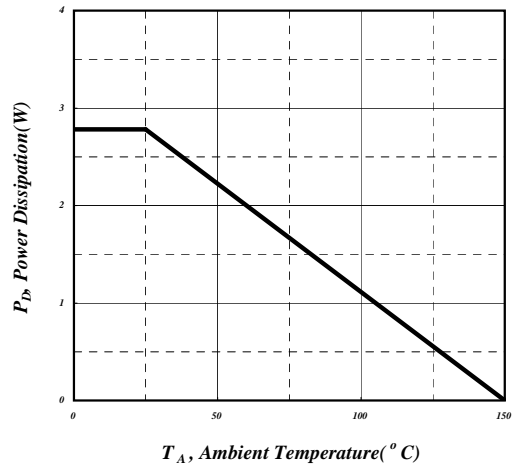

Fig 14. Total Power Dissipation

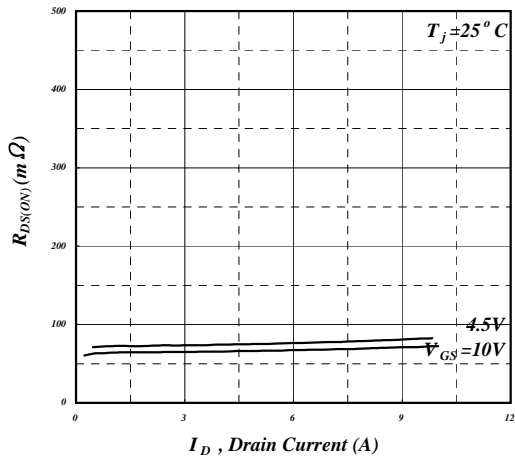
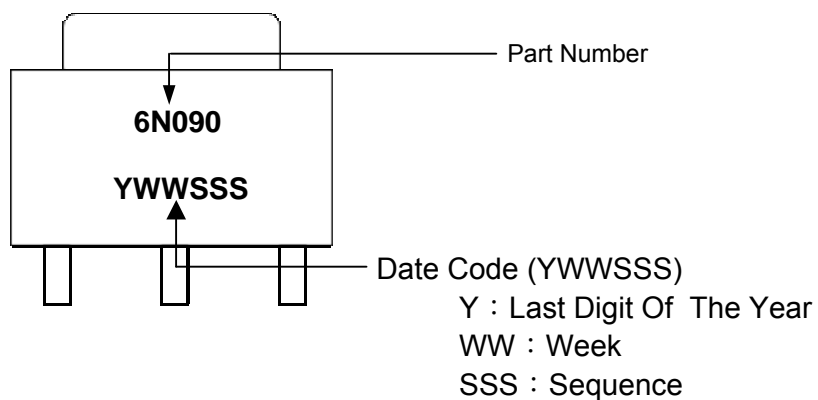

Fig 15. Typ. Drain-Source on State Resistance



AP6N090K

MARKING INFORMATION





Package Outline : SOT-223

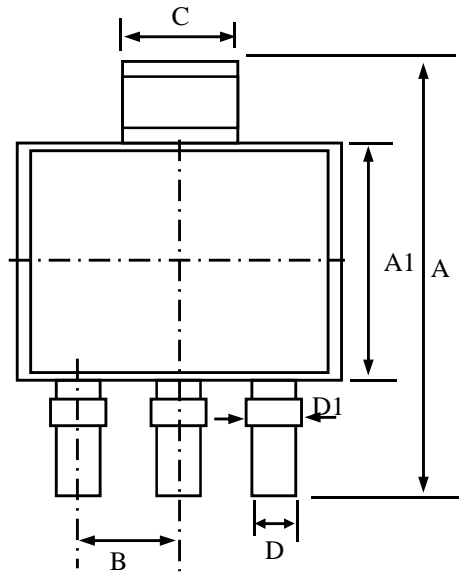

SYMBOLS	Millimeters		
	MIN	NOM	MAX
A	6.70	7.00	7.30
B	---	2.30	---
C	2.90	3.00	3.10
D	0.60	0.70	0.85
G	0.20	0.30	0.35
E	6.30	6.50	6.70
F	1.40	1.60	1.80
K	0.02	0.06	0.10
A1	3.30	3.50	3.70
L	0.50	0.75	1.00
D1	0.70	0.85	1.00

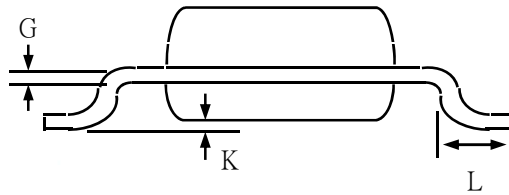
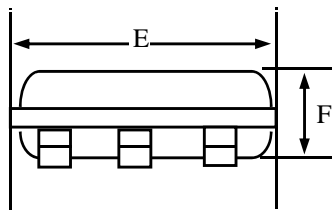

- 1.All Dimension Are In Millimeters.
- 2.Dimension Does Not Include Mold Protrusions.



SOT-223 FOOTPRINT :

