

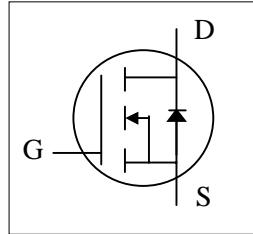

- ▼ 100% R_g & UIS Test
- ▼ Simple Drive Requirement
- ▼ Fast Switching Characteristic
- ▼ RoHS Compliant & Halogen-Free

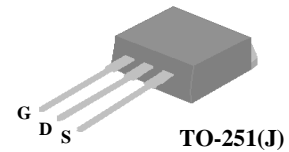

BV_{DSS}	60V
$R_{DS(ON)}$	100m Ω
I_D	7.5A



Description

AP6N100 series are from Advanced Power innovated design and silicon process technology to achieve the lowest possible on-resistance and fast switching performance. It provides the designer with an extreme efficient device for use in a wide range of power applications.

The straight lead version TO-251 package is widely preferred for all commercial-industrial through hole applications.

Absolute Maximum Ratings @T_j=25°C (unless otherwise specified)

Symbol	Parameter	Rating	Units
V_{DS}	Drain-Source Voltage	60	V
V_{GS}	Gate-Source Voltage	± 20	V
$I_D @ T_C = 25^\circ C$	Drain Current, $V_{GS} @ 10V$	7.5	A
$I_D @ T_C = 100^\circ C$	Drain Current, $V_{GS} @ 10V$	4.7	A
I_{DM}	Pulsed Drain Current ¹	30	A
$P_D @ T_C = 25^\circ C$	Total Power Dissipation	12.5	W
$P_D @ T_A = 25^\circ C$	Total Power Dissipation	1.13	W
E_{AS}	Single Pulse Avalanche Energy ³	8.8	mJ
T_{STG}	Storage Temperature Range	-55 to 150	°C
T_J	Operating Junction Temperature Range	-55 to 150	°C

Thermal Data

Symbol	Parameter	Value	Units
R _{thj-c}	Maximum Thermal Resistance, Junction-case	10	°C/W
R _{thj-a}	Maximum Thermal Resistance, Junction-ambient	110	°C/W



AP6N100J

Electrical Characteristics @T_j=25°C(unless otherwise specified)

Symbol	Parameter	Test Conditions	Min.	Typ.	Max.	Units
BV _{DSS}	Drain-Source Breakdown Voltage	V _{GS} =0V, I _D =250uA	60	-	-	V
R _{DS(ON)}	Static Drain-Source On-Resistance ²	V _{GS} =10V, I _D =5A	-	-	100	mΩ
		V _{GS} =4.5V, I _D =3A	-	-	125	mΩ
V _{GS(th)}	Gate Threshold Voltage	V _{DS} =V _{GS} , I _D =250uA	1	-	3	V
g _{fs}	Forward Transconductance	V _{DS} =10V, I _D =5A	-	14	-	S
I _{DSS}	Drain-Source Leakage Current	V _{DS} =48V, V _{GS} =0V	-	-	25	uA
I _{GSS}	Gate-Source Leakage	V _{GS} =±20V, V _{DS} =0V	-	-	±100	nA
Q _g	Total Gate Charge	I _D =5A	-	10	16	nC
Q _{gs}	Gate-Source Charge	V _{DS} =48V	-	1.5	-	nC
Q _{gd}	Gate-Drain ("Miller") Charge	V _{GS} =10V	-	2	-	nC
t _{d(on)}	Turn-on Delay Time	V _{DS} =30V	-	4	-	ns
t _r	Rise Time	I _D =5A	-	11	-	ns
t _{d(off)}	Turn-off Delay Time	R _G =3.3Ω	-	13	-	ns
t _f	Fall Time	V _{GS} =10V	-	2	-	ns
C _{iss}	Input Capacitance	V _{GS} =0V	-	420	672	pF
C _{oss}	Output Capacitance	V _{DS} =30V	-	32	-	pF
C _{rss}	Reverse Transfer Capacitance	f=1.0MHz	-	24	-	pF
R _g	Gate Resistance	f=1.0MHz	-	0.9	1.8	Ω

Source-Drain Diode

Symbol	Parameter	Test Conditions	Min.	Typ.	Max.	Units
V _{SD}	Forward On Voltage ²	I _S =5A, V _{GS} =0V	-	-	1.3	V
t _{rr}	Reverse Recovery Time	I _S =5A, V _{GS} =0V,	-	11	-	ns
Q _{rr}	Reverse Recovery Charge	di/dt=100A/μs	-	6	-	nC

Notes:

- 1.Pulse width limited by Max. junction temperature.
- 2.Pulse test
- 3.Starting T_j=25°C , V_{DD}=30V , L=1mH , R_G=25Ω

THIS PRODUCT IS SENSITIVE TO ELECTROSTATIC DISCHARGE, PLEASE HANDLE WITH CAUTION.

USE OF THIS PRODUCT AS A CRITICAL COMPONENT IN LIFE SUPPORT OR OTHER SIMILAR SYSTEMS IS NOT AUTHORIZED.

APEC DOES NOT ASSUME ANY LIABILITY ARISING OUT OF THE APPLICATION OR USE OF ANY PRODUCT OR CIRCUIT DESCRIBED HEREIN; NEITHER DOES IT CONVEY ANY LICENSE UNDER ITS PATENT RIGHTS, NOR THE RIGHTS OF OTHERS.

APEC RESERVES THE RIGHT TO MAKE CHANGES WITHOUT FURTHER NOTICE TO ANY PRODUCTS HEREIN TO IMPROVE RELIABILITY, FUNCTION OR DESIGN.

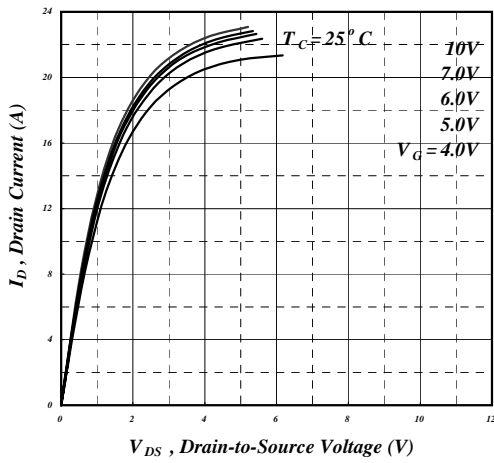

Fig 1. Typical Output Characteristics

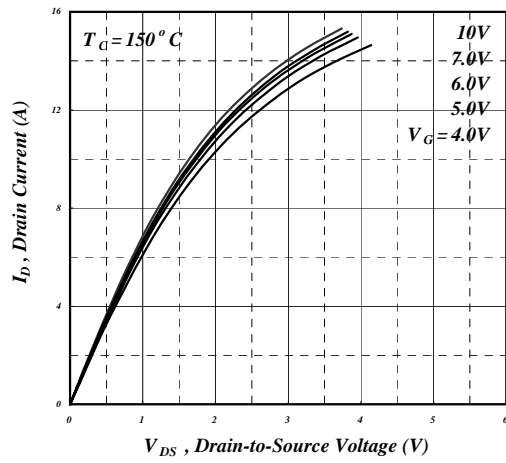

Fig 2. Typical Output Characteristics

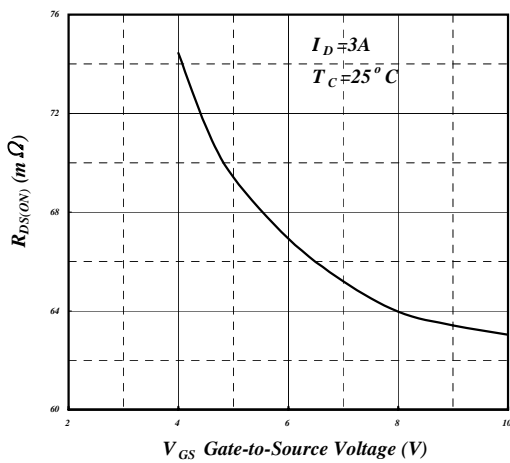

Fig 3. On-Resistance v.s. Gate Voltage

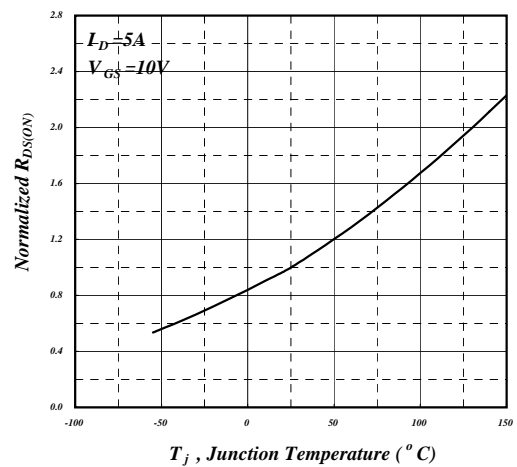

Fig 4. Normalized On-Resistance v.s. Junction Temperature

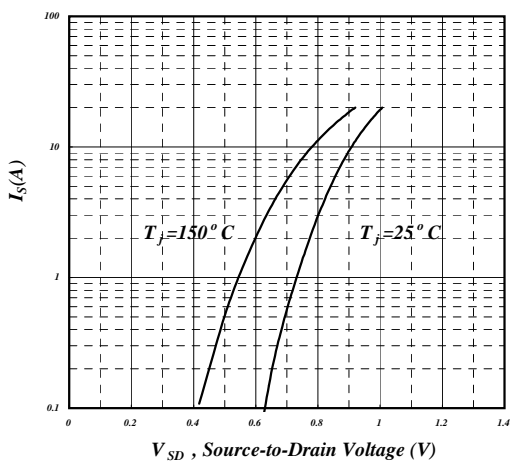

Fig 5. Forward Characteristic of Reverse Diode

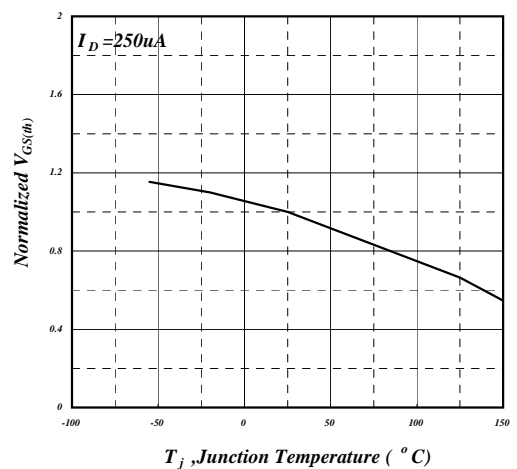

Fig 6. Gate Threshold Voltage v.s. Junction Temperature

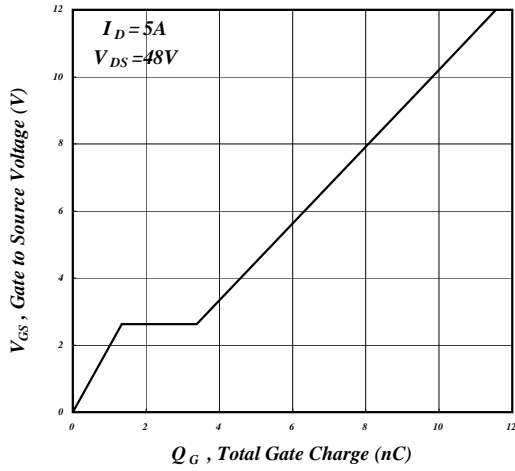

Fig 7. Gate Charge Characteristics

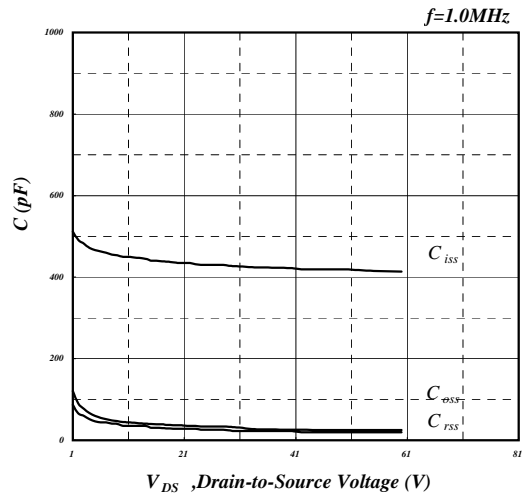

Fig 8. Typical Capacitance Characteristics

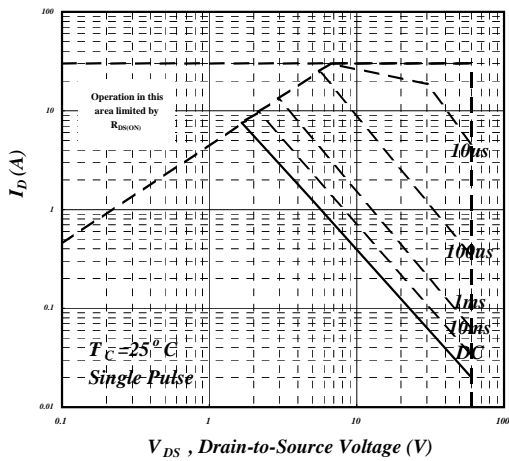

Fig 9. Maximum Safe Operating Area

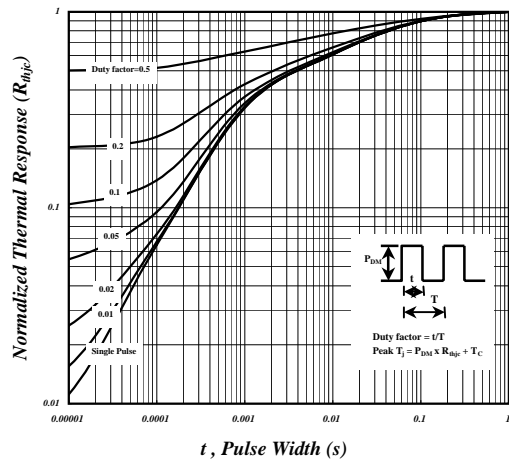

Fig 10. Effective Transient Thermal Impedance

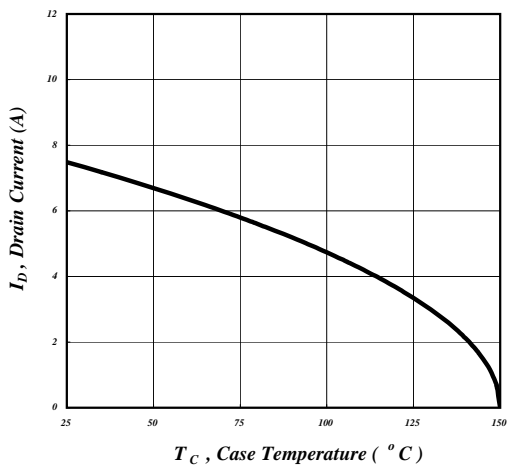

Fig 11. Drain Current v.s. Case Temperature

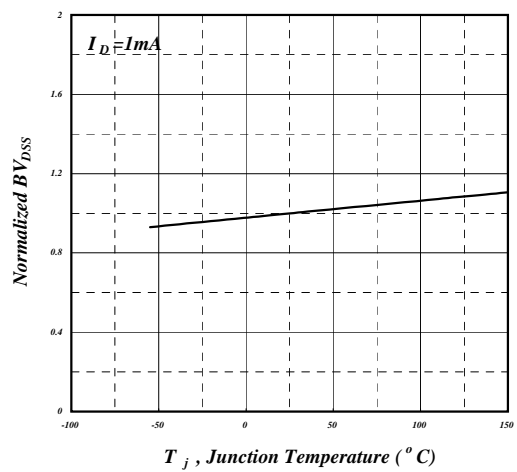

Fig 12. Normalized BV_{DSS} v.s. Junction Temperature

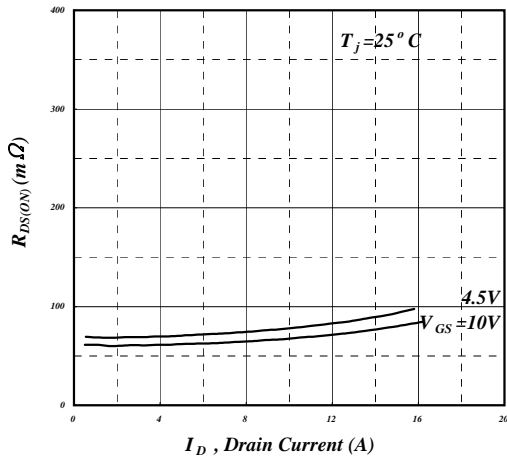

Fig 13. Typ. Drain-Source on State Resistance

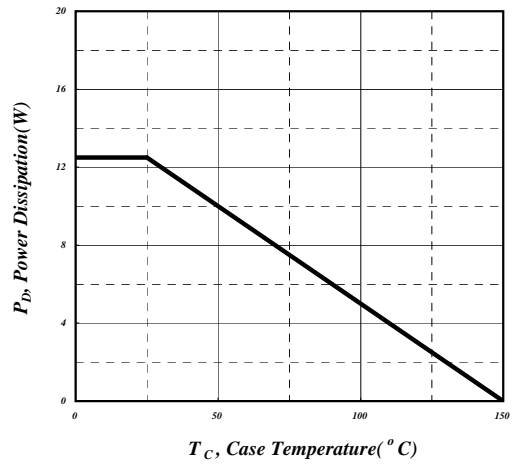

Fig 14. Total Power Dissipation

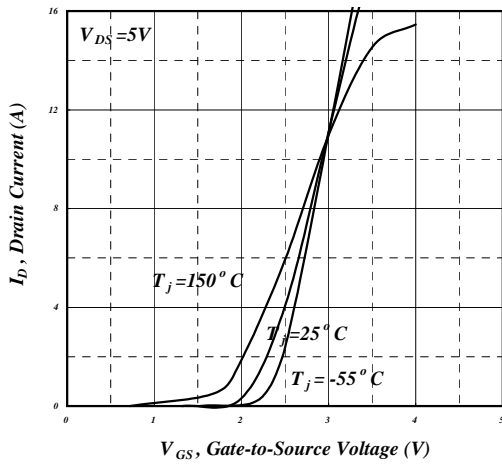
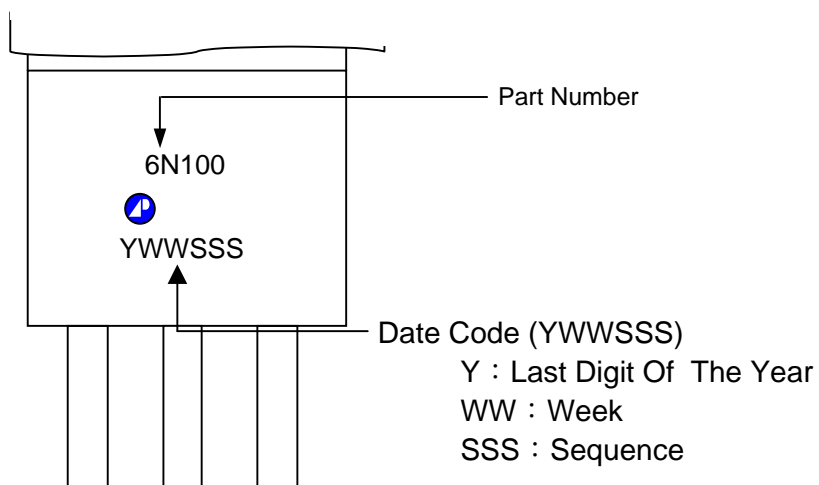

Fig 15. Transfer Characteristics



AP6N100J

MARKING INFORMATION





Package Outline : TO-251

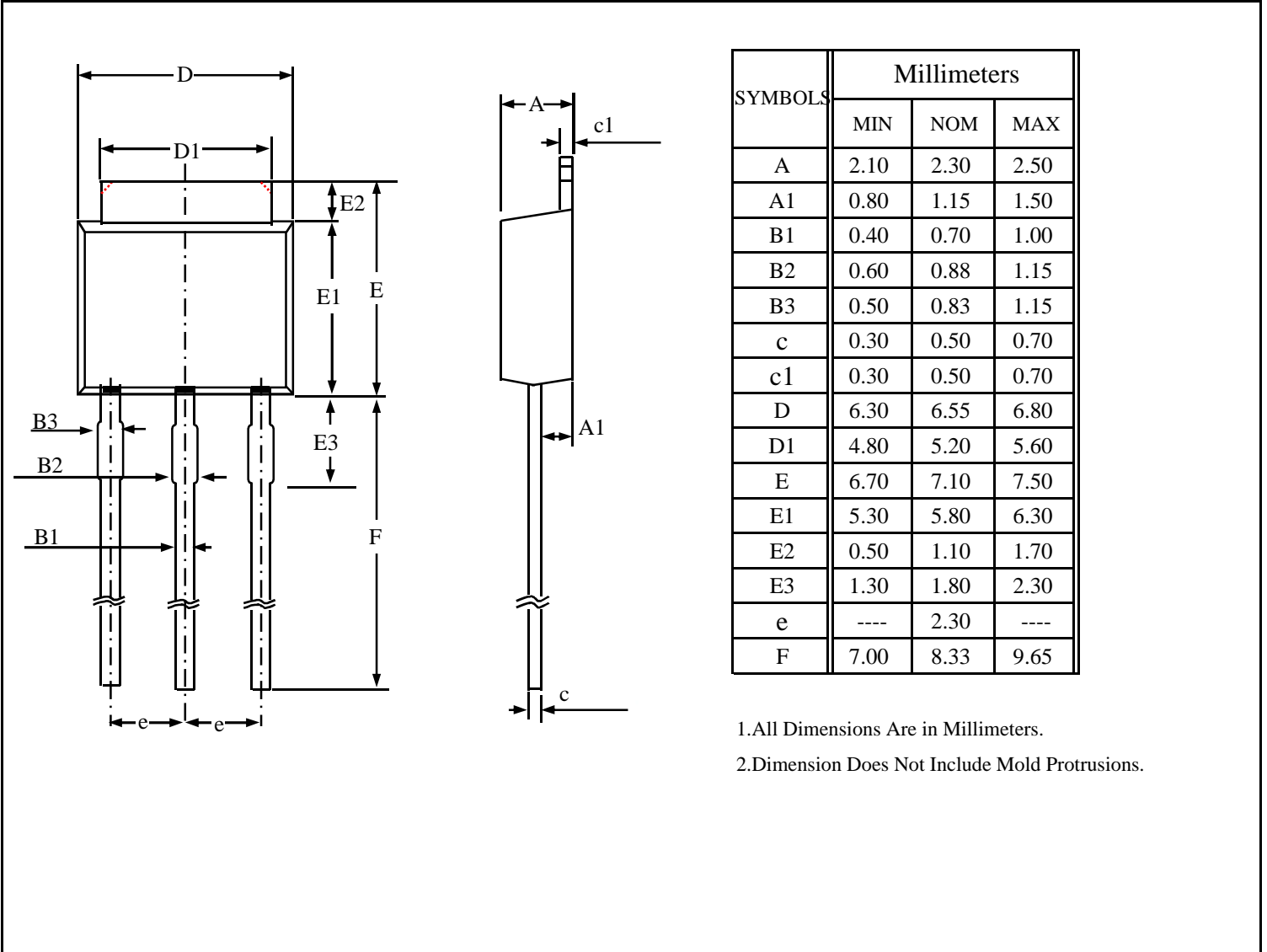



TO-251 FOOTPRINT :

