

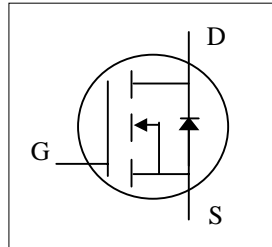

- ▼ 100% R_g & UIS Test
- ▼ Fast Switching Characteristic
- ▼ Simple Drive Requirement
- ▼ RoHS Compliant & Halogen-Free

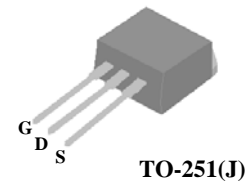

V _{DS} @ T _{j,max.}	750V
R _{DS(ON)}	0.38 Ω
I _D ³	11A



Description

AP70SL380A series are from Advanced Power innovated design and silicon process technology to achieve the lowest possible on-resistance and fast switching performance. It provides the designer with an extreme efficient device for use in a wide range of power applications.

The straight lead version TO-251 package is widely preferred for all commercial-industrial through hole applications.

Absolute Maximum Ratings @T_j=25°C (unless otherwise specified)

Symbol	Parameter	Rating	Units
V _{DS}	Drain-Source Voltage	700	V
V _{GS}	Gate-Source Voltage	±20	V
I _D @T _C =25°C	Drain Current, V _{GS} @ 10V ³	11	A
I _D @T _C =100°C	Drain Current, V _{GS} @ 10V ³	6.5	A
I _{DM}	Pulsed Drain Current ¹	24	A
dv/dt	MOSFET dv/dt Ruggedness (V _{DS} = 0 ...400V)	50	V/ns
P _D @T _C =25°C	Total Power Dissipation	78.1	W
P _D @T _A =25°C	Total Power Dissipation	1.13	W
E _{AS}	Single Pulse Avalanche Energy ⁴	75	mJ
dv/dt	Peak Diode Recovery dv/dt ⁵	15	V/ns
T _{STG}	Storage Temperature Range	-55 to 150	°C
T _J	Operating Junction Temperature Range	-55 to 150	°C

Thermal Data

Symbol	Parameter	Value	Units
R _{thj-c}	Maximum Thermal Resistance, Junction-case	1.6	°C/W
R _{thj-a}	Maximum Thermal Resistance, Junction-ambient	110	°C/W



AP70SL380AJ

Electrical Characteristics @T_j=25°C(unless otherwise specified)

Symbol	Parameter	Test Conditions	Min.	Typ.	Max.	Units
BV _{DSS}	Drain-Source Breakdown Voltage	V _{GS} =0V, I _D =250uA	700	-	-	V
R _{DS(ON)}	Static Drain-Source On-Resistance ²	V _{GS} =10V, I _D =3.2A	-	-	0.38	Ω
V _{GS(th)}	Gate Threshold Voltage	V _{DS} =V _{GS} , I _D =250uA	2	-	5	V
g _{fs}	Forward Transconductance	V _{DS} =10V, I _D =3.2A	-	7.8	-	S
I _{DSS}	Drain-Source Leakage Current	V _{DS} =480V, V _{GS} =0V	-	-	100	uA
I _{GSS}	Gate-Source Leakage	V _{GS} =±20V, V _{DS} =0V	-	-	±100	nA
Q _g	Total Gate Charge	I _D =3.2A	-	33	52.8	nC
Q _{gs}	Gate-Source Charge	V _{DS} =560V	-	8	-	nC
Q _{gd}	Gate-Drain ("Miller") Charge	V _{GS} =10V	-	13	-	nC
t _{d(on)}	Turn-on Delay Time	V _{DD} =350V	-	13	-	ns
t _r	Rise Time	I _D =3.2A	-	8	-	ns
t _{d(off)}	Turn-off Delay Time	R _G =3.3Ω	-	37	-	ns
t _f	Fall Time	V _{GS} =10V	-	12	-	ns
C _{iss}	Input Capacitance	V _{GS} =0V	-	1240	1984	pF
C _{oss}	Output Capacitance	V _{DS} =100V	-	35	-	pF
C _{rss}	Reverse Transfer Capacitance	f=1.0MHz	-	5	-	pF
R _g	Gate Resistance	f=1.0MHz	-	3.5	7	Ω

Source-Drain Diode

Symbol	Parameter	Test Conditions	Min.	Typ.	Max.	Units
V _{SD}	Forward On Voltage ²	I _S =3.2A, V _{GS} =0V	-	0.8	-	V
t _{rr}	Reverse Recovery Time	I _S =11A, V _{GS} =0V	-	320	-	ns
Q _{rr}	Reverse Recovery Charge	di/dt=50A/μs	-	2.5	-	μC

Notes:

- 1.Pulse width limited by max. junction temperature.
- 2.Pulse test
- 3.Limited by max. junction temperature. Maximum duty cycle D=0.75
- 4.Starting T_j=25°C , V_{DD}=50V , L=150mH , R_G=25Ω
- 5.I_{SD} ≤ I_D, V_{DD} ≤ BV_{DSS}, starting T_J = 25°C

THIS PRODUCT IS SENSITIVE TO ELECTROSTATIC DISCHARGE, PLEASE HANDLE WITH CAUTION.

USE OF THIS PRODUCT AS A CRITICAL COMPONENT IN LIFE SUPPORT OR OTHER SIMILAR SYSTEMS IS NOT AUTHORIZED.

APEC DOES NOT ASSUME ANY LIABILITY ARISING OUT OF THE APPLICATION OR USE OF ANY PRODUCT OR CIRCUIT DESCRIBED HEREIN; NEITHER DOES IT CONVEY ANY LICENSE UNDER ITS PATENT RIGHTS, NOR THE RIGHTS OF OTHERS.

APEC RESERVES THE RIGHT TO MAKE CHANGES WITHOUT FURTHER NOTICE TO ANY PRODUCTS HEREIN TO IMPROVE RELIABILITY, FUNCTION OR DESIGN.

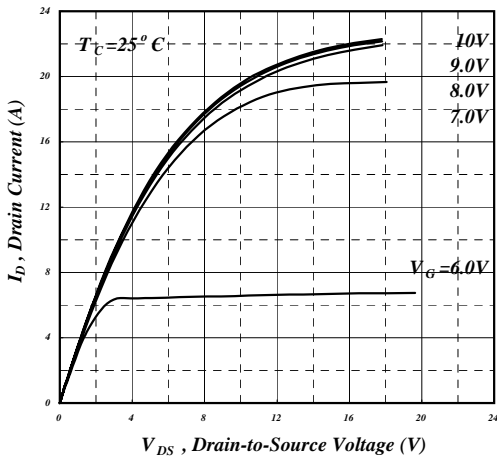

Fig 1. Typical Output Characteristics

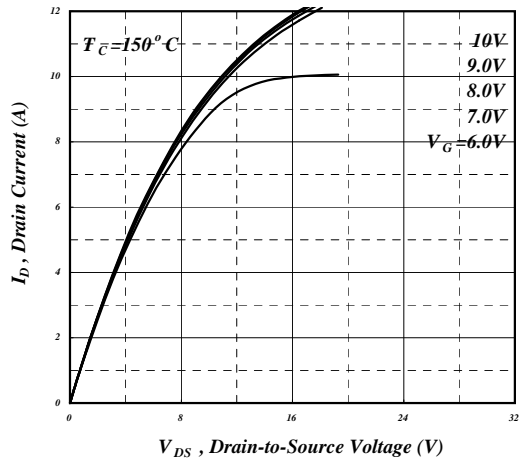

Fig 2. Typical Output Characteristics

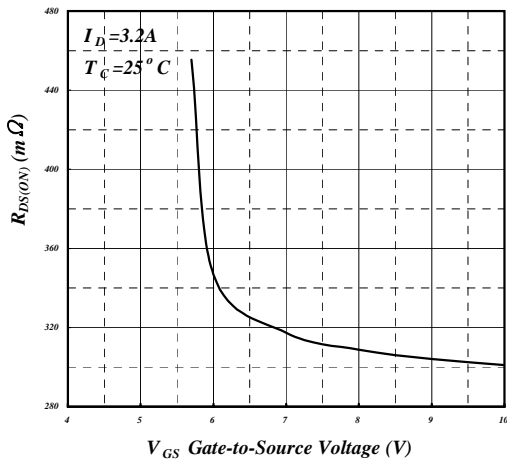

Fig 3. On-Resistance v.s. Gate Voltage

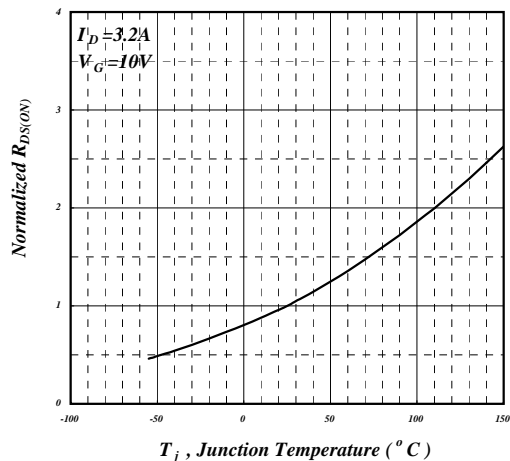

Fig 4. Normalized On-Resistance v.s. Junction Temperature

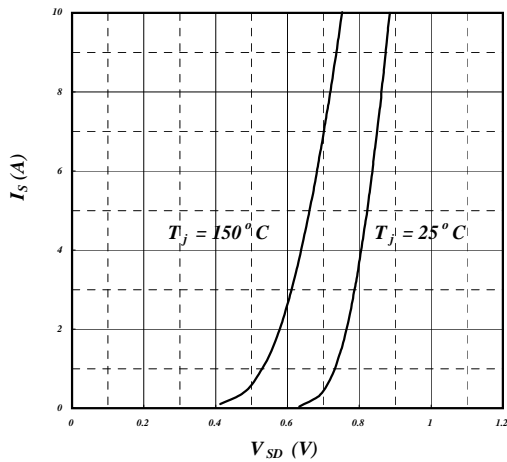

Fig 5. Forward Characteristic of Reverse Diode

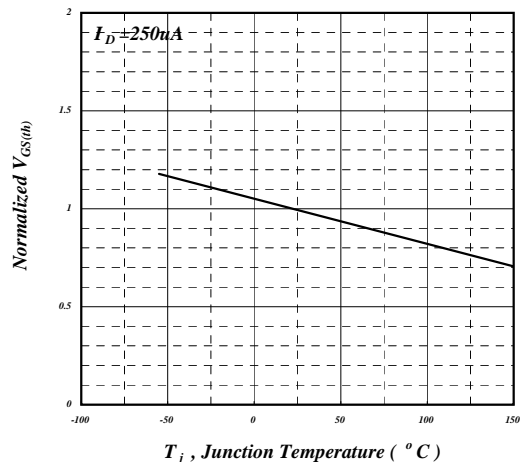

Fig 6. Gate Threshold Voltage v.s. Junction Temperature

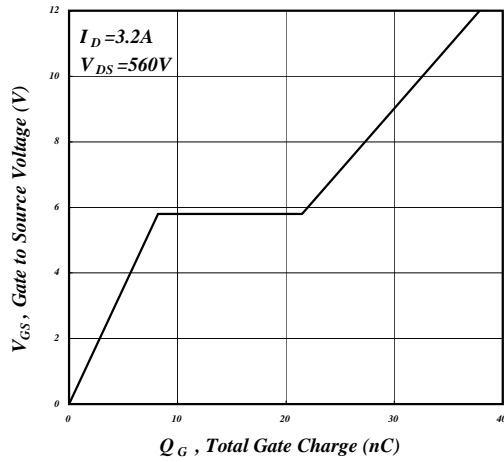

Fig 7. Gate Charge Characteristics

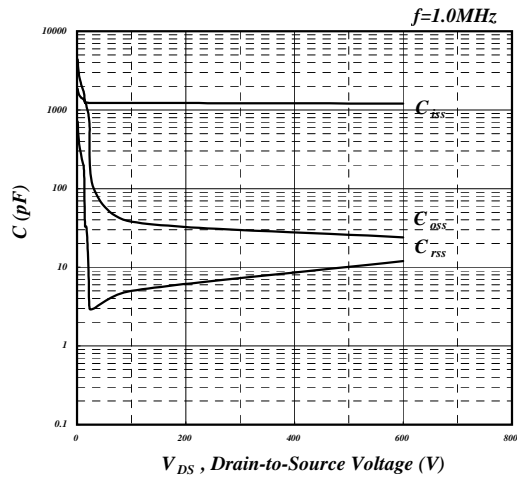

Fig 8. Typical Capacitance Characteristics

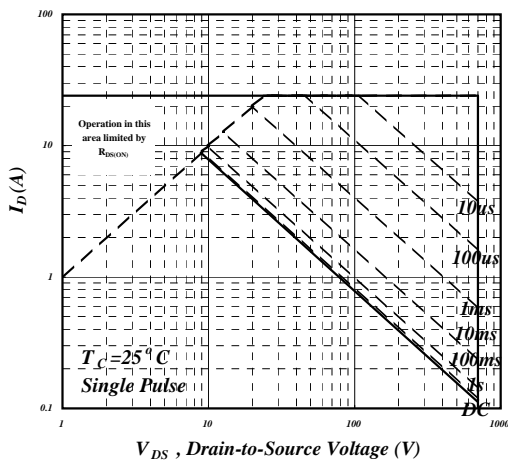

Fig 9. Maximum Safe Operating Area

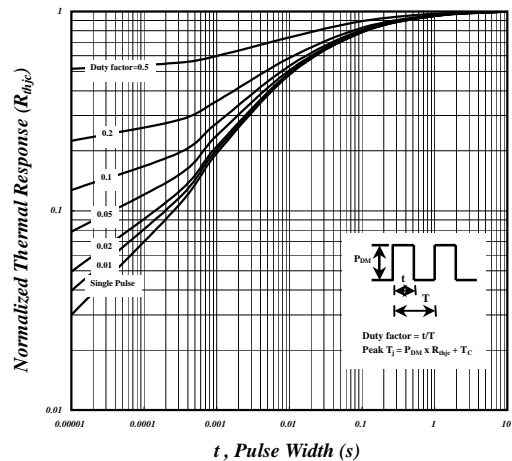

Fig 10. Effective Transient Thermal Impedance

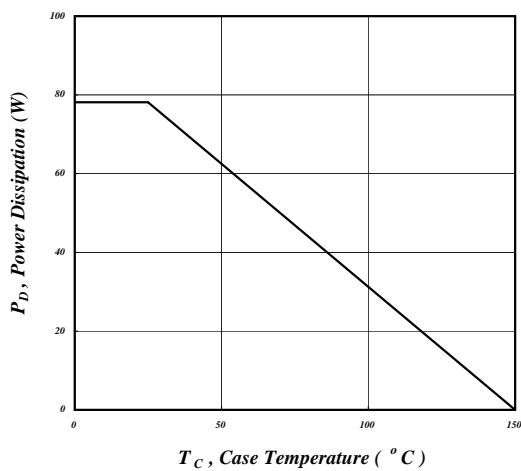

Fig 11. Total Power Dissipation

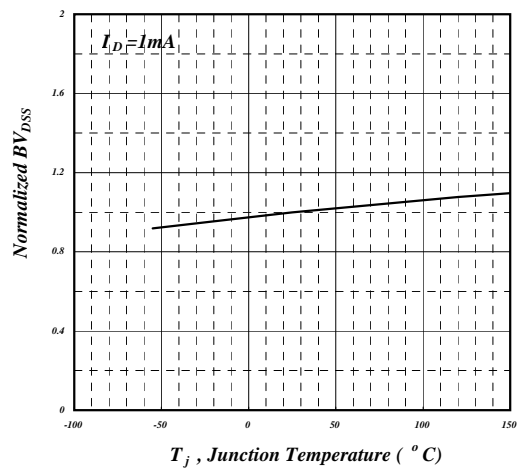
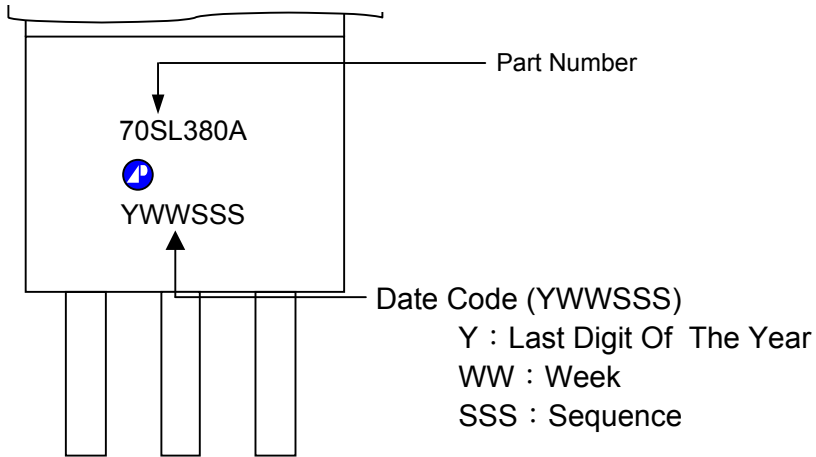

Fig 12. Normalized BV_{DS} v.s. Junction Temperature



MARKING INFORMATION





Package Outline : TO-251

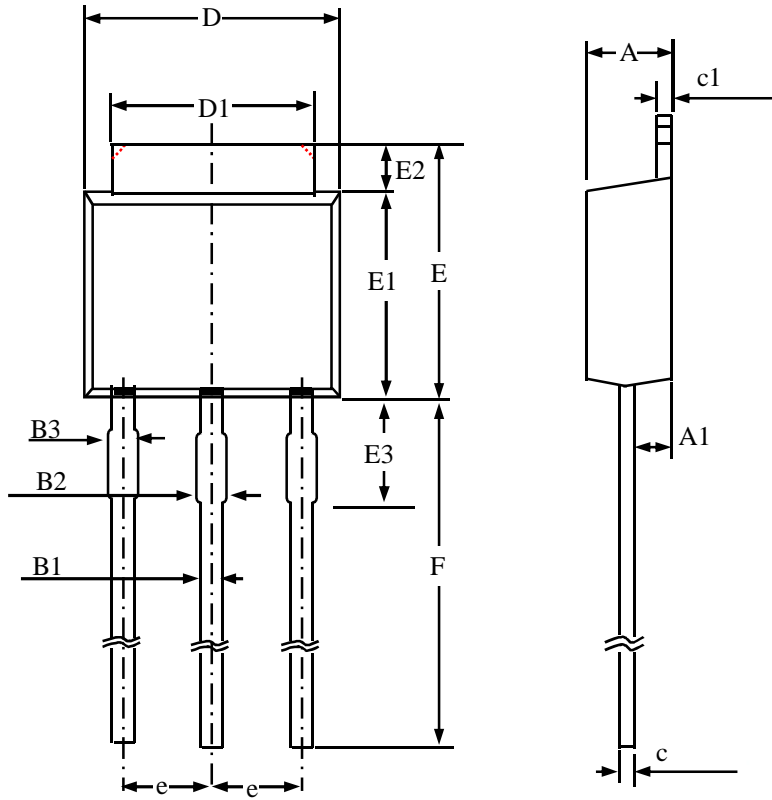

SYMBOLS	Millimeters		
	MIN	NOM	MAX
A	2.10	2.30	2.50
A1	0.80	1.15	1.50
B1	0.40	0.70	1.00
B2	0.60	0.88	1.15
B3	0.50	0.83	1.15
c	0.30	0.50	0.70
c1	0.30	0.50	0.70
D	6.30	6.55	6.80
D1	4.80	5.20	5.60
E	6.70	7.10	7.50
E1	5.30	5.80	6.30
E2	0.50	1.10	1.70
E3	1.30	1.80	2.30
e	----	2.30	----
F	7.00	8.33	9.65

- 1.All Dimensions Are in Millimeters.
- 2.Dimension Does Not Include Mold Protrusions.



TO-251 FOOTPRINT :

