

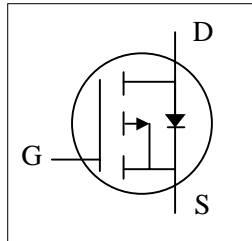

- ▼ Lower On-resistance
- ▼ Simple Drive Requirement
- ▼ Fast Switching Characteristic
- ▼ RoHS Compliant & Halogen-Free



BV_{DSS}	-200V
$R_{DS(ON)}$	680m Ω
I_D	-8A

Description

AP9120 series are from Advanced Power innovated design and silicon process technology to achieve the lowest possible on-resistance and fast switching performance. It provides the designer with an extreme efficient device for use in a wide range of power applications.

The TO-252 package is widely preferred for all commercial-industrial surface mount applications using infrared reflow technique and suited for high current application due to the low connection resistance. The through-hole version (AP9120GJ) are available for low-profile applications.

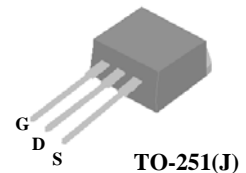
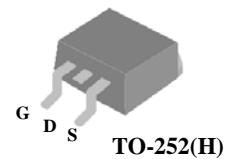

Absolute Maximum Ratings @ $T_j=25^\circ\text{C}$ (unless otherwise specified)

Symbol	Parameter	Rating	Units
V_{DS}	Drain-Source Voltage	-200	V
V_{GS}	Gate-Source Voltage	+20	V
$I_D@T_C=25^\circ\text{C}$	Drain Current, V_{GS} @ 10V	-8	A
$I_D@T_C=100^\circ\text{C}$	Drain Current, V_{GS} @ 10V	-5	A
I_{DM}	Pulsed Drain Current ¹	30	A
$P_D@T_C=25^\circ\text{C}$	Total Power Dissipation	96	W
	Linear Derating Factor	0.77	W/ $^\circ\text{C}$
T_{STG}	Storage Temperature Range	-55 to 150	$^\circ\text{C}$
T_J	Operating Junction Temperature Range	-55 to 150	$^\circ\text{C}$

Thermal Data

Symbol	Parameter	Value	Units
Rthj-c	Maximum Thermal Resistance, Junction-case	1.3	$^\circ\text{C}/\text{W}$
Rthj-a	Maximum Thermal Resistance, Junction-ambient (PCB mount) ³	62.5	$^\circ\text{C}/\text{W}$
Rthj-a	Maximum Thermal Resistance, Junction-ambient	110	$^\circ\text{C}/\text{W}$



AP9120GH/J-HF

Electrical Characteristics @T_j=25°C(unless otherwise specified)

Symbol	Parameter	Test Conditions	Min.	Typ.	Max.	Units
BV _{DSS}	Drain-Source Breakdown Voltage	V _{GS} =0V, I _D =-250uA	-200	-	-	V
R _{DS(ON)}	Static Drain-Source On-Resistance ²	V _{GS} =-10V, I _D =-4A	-	-	680	mΩ
V _{GS(th)}	Gate Threshold Voltage	V _{DS} =V _{GS} , I _D =-250uA	-2	-	-4	V
g _{fs}	Forward Transconductance	V _{DS} =-10V, I _D =-5A	-	7	-	S
I _{DSS}	Drain-Source Leakage Current	V _{DS} =-200V, V _{GS} =0V	-	-	-25	uA
	Drain-Source Leakage Current (T _j =125°C)	V _{DS} =-160V, V _{GS} =0V	-	-	-250	uA
I _{GSS}	Gate-Source Leakage	V _{GS} = ±20V, V _{DS} =0V	-	-	±100	nA
Q _g	Total Gate Charge ²	I _D =-5A	-	35	56	nC
Q _{gs}	Gate-Source Charge	V _{DS} =-160V	-	6	-	nC
Q _{gd}	Gate-Drain ("Miller") Charge	V _{GS} =-10V	-	15	-	nC
t _{d(on)}	Turn-on Delay Time ²	V _{DS} =-100V	-	13.5	-	ns
t _r	Rise Time	I _D =-5A	-	16	-	ns
t _{d(off)}	Turn-off Delay Time	R _G =10Ω	-	52	-	ns
t _f	Fall Time	V _{GS} =-10V	-	25	-	ns
C _{iss}	Input Capacitance	V _{GS} =0V	-	1210	-	pF
C _{oss}	Output Capacitance	V _{DS} =-25V	-	170	-	pF
C _{rss}	Reverse Transfer Capacitance	f=1.0MHz	-	45	-	pF
R _g	Gate Resistance	f=1.0MHz	-	3.6	5.4	Ω

Source-Drain Diode

Symbol	Parameter	Test Conditions	Min.	Typ.	Max.	Units
V _{SD}	Forward On Voltage ²	I _S =-5A, V _{GS} =0V	-	-	-1.3	V
t _{rr}	Reverse Recovery Time ²	I _S =-5A, V _{GS} =0V,	-	200	-	ns
Q _{rr}	Reverse Recovery Charge	dI/dt=-100A/μs	-	2	-	uC

Notes:

- 1.Pulse width limited by Max. junction temperature.
- 2.Pulse test
- 3.Surface mounted on 1 in² copper pad of FR4 board

THIS PRODUCT IS SENSITIVE TO ELECTROSTATIC DISCHARGE, PLEASE HANDLE WITH CAUTION.

USE OF THIS PRODUCT AS A CRITICAL COMPONENT IN LIFE SUPPORT OR OTHER SIMILAR SYSTEMS IS NOT AUTHORIZED.

APEC DOES NOT ASSUME ANY LIABILITY ARISING OUT OF THE APPLICATION OR USE OF ANY PRODUCT OR CIRCUIT DESCRIBED HEREIN; NEITHER DOES IT CONVEY ANY LICENSE UNDER ITS PATENT RIGHTS, NOR THE RIGHTS OF OTHERS.

APEC RESERVES THE RIGHT TO MAKE CHANGES WITHOUT FURTHER NOTICE TO ANY PRODUCTS HEREIN TO IMPROVE RELIABILITY, FUNCTION OR DESIGN.

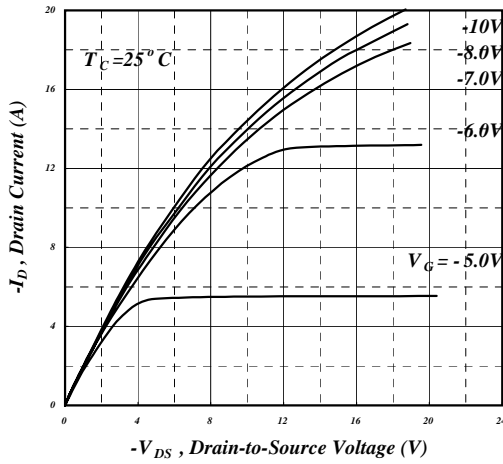

Fig 1. Typical Output Characteristics

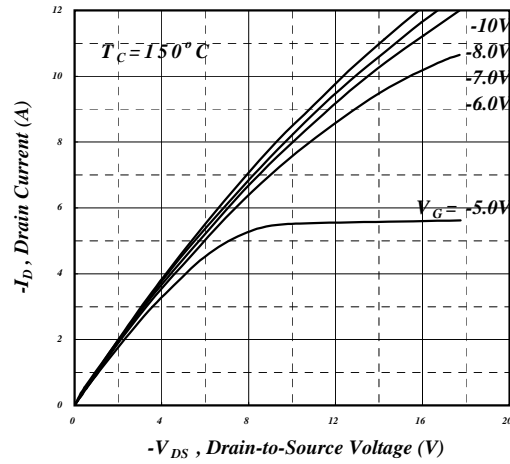

Fig 2. Typical Output Characteristics

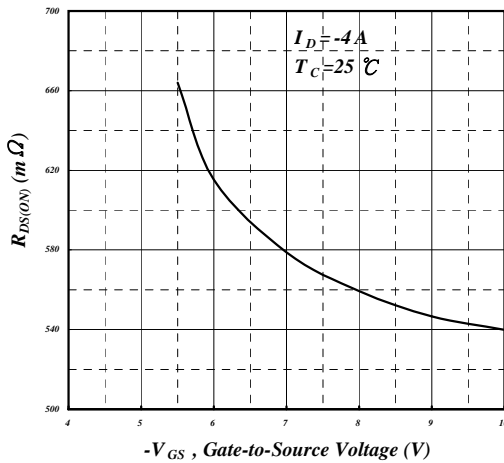

Fig 3. On-Resistance v.s. Gate Voltage

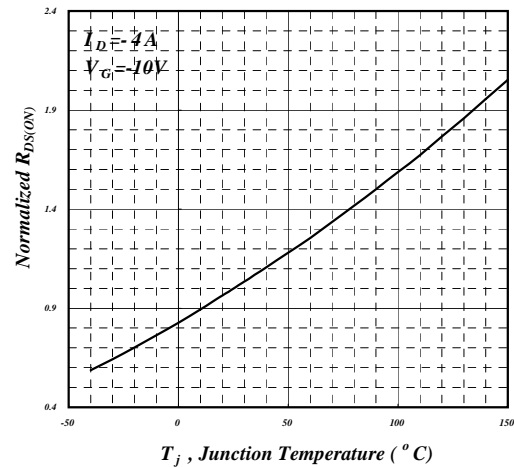

Fig 4. Normalized On-Resistance v.s. Junction Temperature

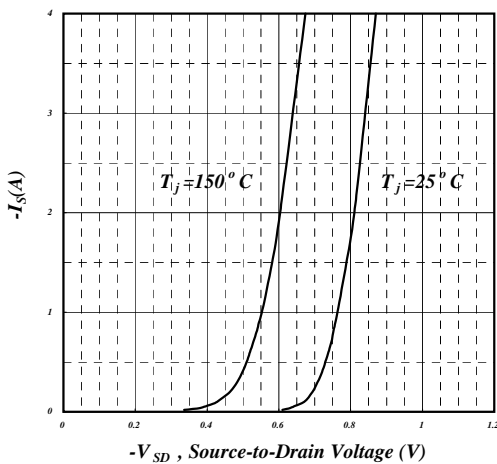

Fig 5. Forward Characteristic of Reverse Diode

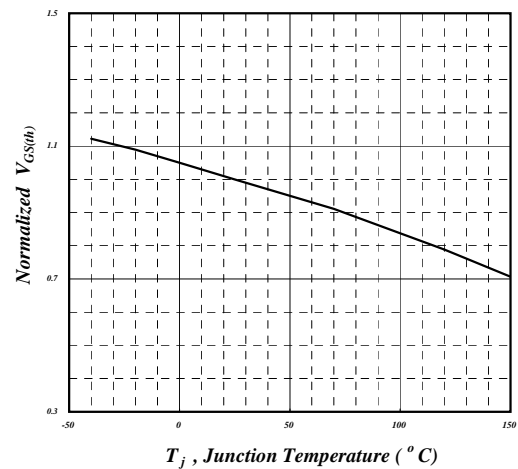

Fig 6. Gate Threshold Voltage v.s. Junction Temperature

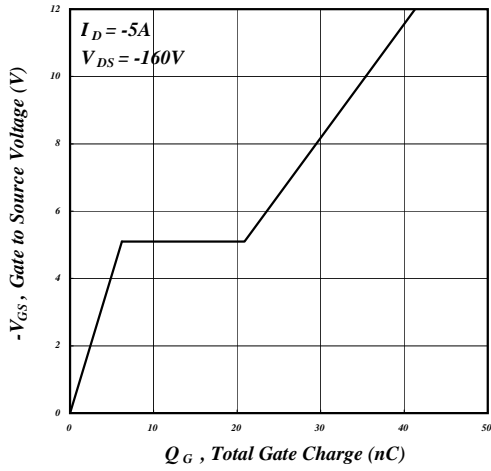

Fig 7. Gate Charge Characteristics

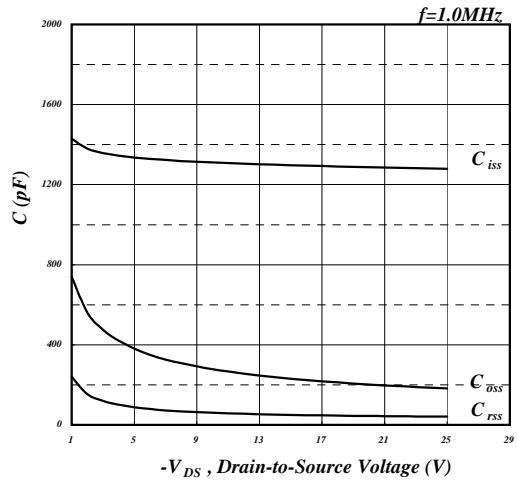

Fig 8. Typical Capacitance Characteristics

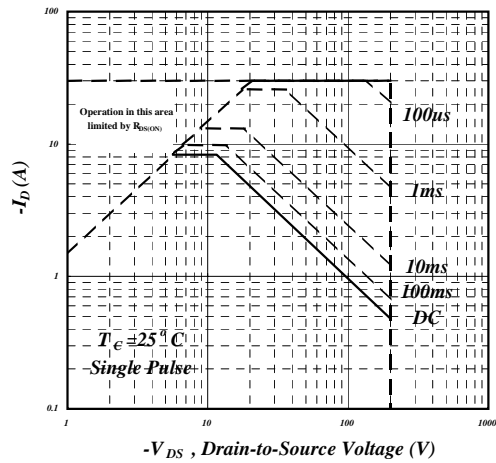

Fig 9. Maximum Safe Operating Area

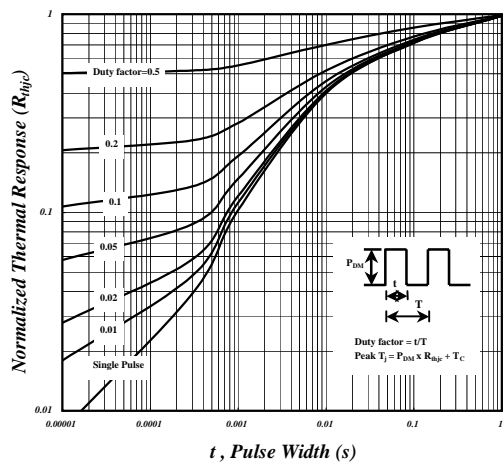

Fig 10. Effective Transient Thermal Impedance

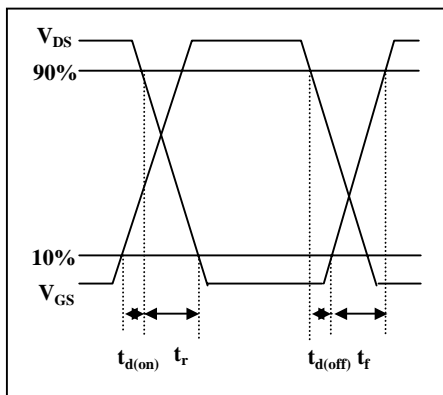

Fig 11. Switching Time Waveform

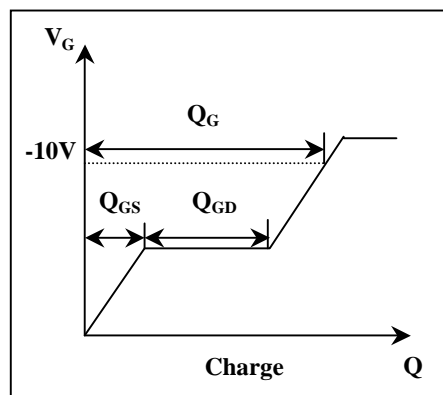
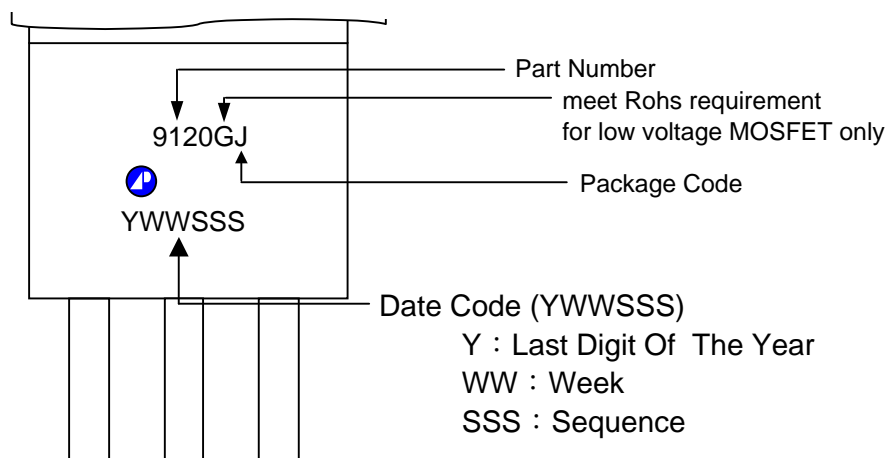

Fig 12. Gate Charge Waveform



MARKING INFORMATION

TO-251



TO-252

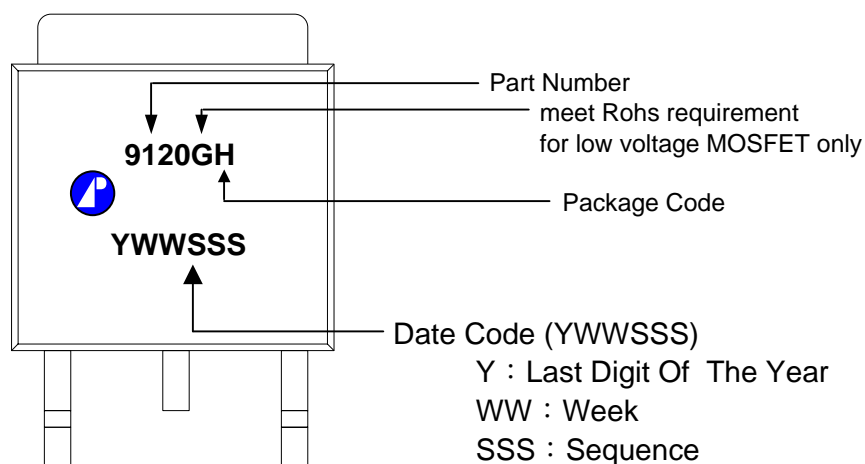



Package Outline : TO-252



SYMBOLS	Millimeters		
	MIN	NOM	MAX
A2	2.18	2.30	2.40
A3	0.40	0.50	0.65
B	0.40	0.70	1.00
B1	0.50	0.85	1.20
D	6.00	6.50	6.80
D1	4.80	5.35	5.90
E3	4.00 (ref.)		
F	2.00	2.63	3.05
F1	0.50	0.85	1.20
E1	5.00	5.70	6.30
E2	0.50	1.10	1.80
e	2.3 (ref)		
C	0.35	0.525	0.70
A1	0.00	—	0.25
B2	—	—	1.25
L	0.90	1.34	1.78



1. All Dimensions Are in Millimeters.
2. Dimension Does Not Include Mold Protrusions.
3. Thermal PAD, Body and Pin contour is for reference, it may has little difference by option.



TO-252 FOOTPRINT :

